

PRODUCT DATA SHEET

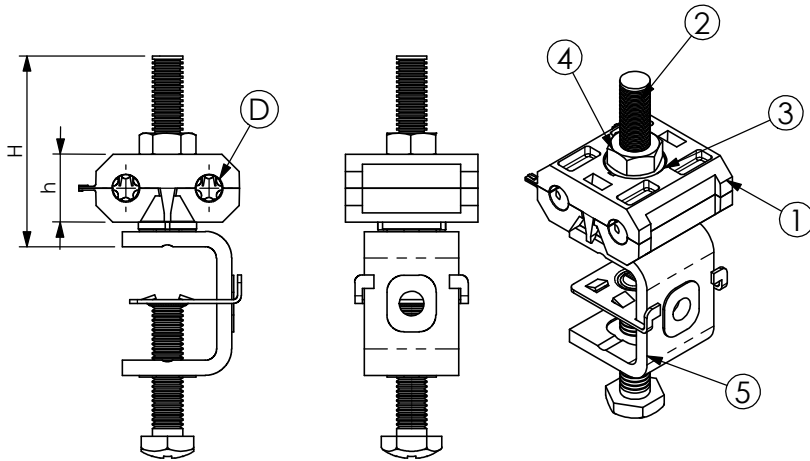

A) SPECIFICATIONS

- 1 Calibrated double black saddles made in PA.66
- 2 Stainless steel threaded bar BFI M8
- 3 Stainless steel flat Washer RPI 8/16
- 4 Stainless steel hexagonal nut DAI 8
- 5 Stainless steel MIM 8 clamp

B) RESISTANCE TESTS

UV Test BS-ISO 105-B06
 Vibration test conforming to UNI 60068-2-6
 Operating temperature: -30°C +120°C

C) PACKAGING INFORMATION

Packing in boxes.
 Label indicating:
 product code, article, quantity,
 production batch,
 FIMO logo and figure.
 (Customer code on request).

D) MOUNTING INSTRUCTIONS

On request

CODE	ARTICLE	ø D	h	H	BOX	WEIGHT
61 1570 0207	MCC 2x7	5 - 7	50	18.5	20	120
61 1570 0209	MCC 2x9	7 - 9	50	18.5	20	120
61 1570 0211	MCC 2x11	9 - 11	50	18.5	20	120
61 1570 0214	MCC 2x14	11 - 14	50	24	20	130
61 1570 0212	MCC 2x1/2"	14 - 17	50	24	20	126
61 1570 0220	MCC 2x20	17 - 20	50	33	20	153

RI	DATE	DR	DATE	AP	Description:
02					MCC - Mini clamps type MCO+MIM 8/25
01					
00	29/01/16	G.S.	29/01/16	A.V.	
1 ST EMISSION					
					Use: Fastening of 2 cables on flat iron with holes