

## **Inter-Series Adaptors** **Adapter zwischen den Serien**

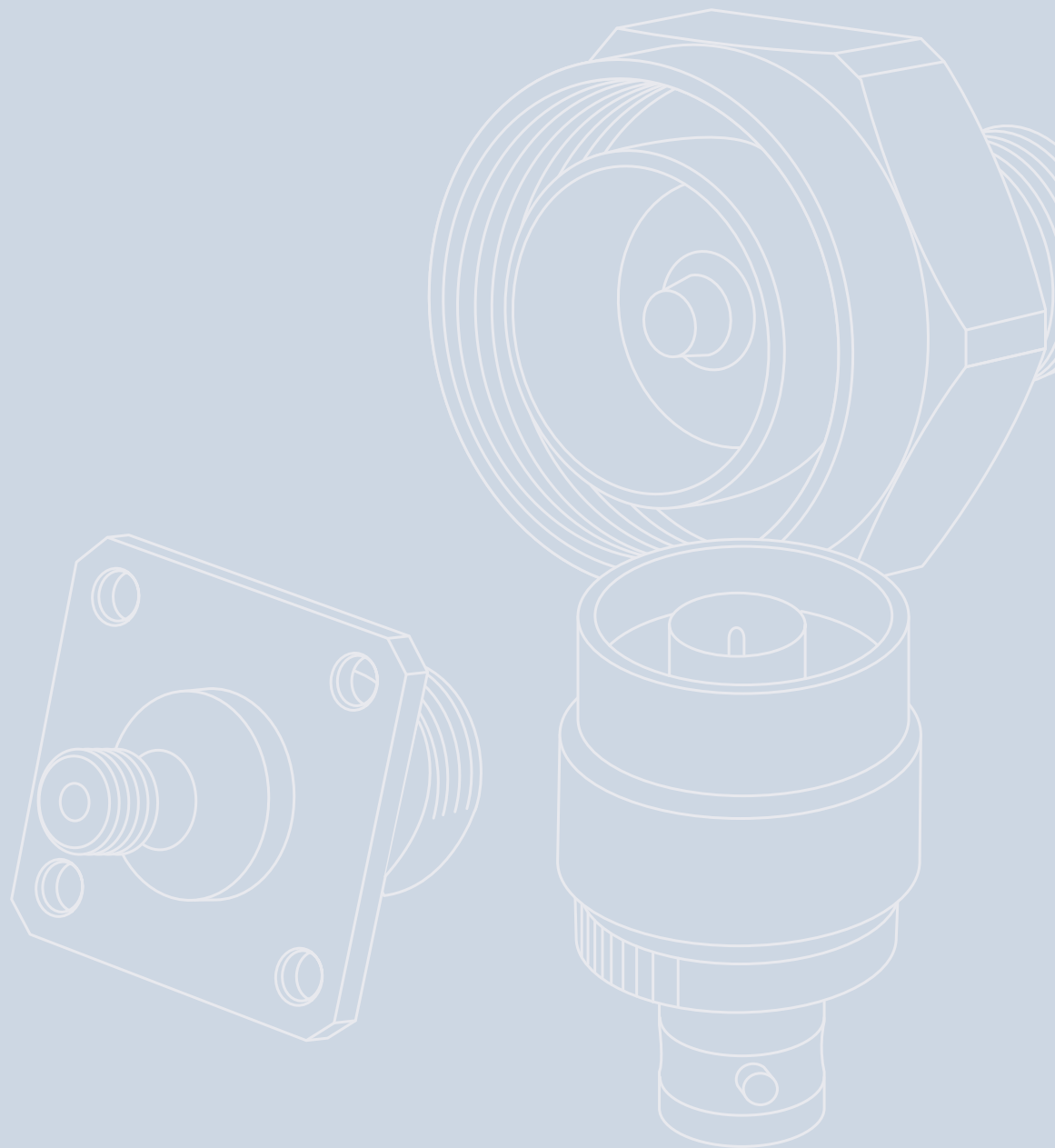



# 19

## Inter-Series Adaptors Adapter zwischen den Serien

19.1 BNC to TNC .....	299	19.1 BNC auf TNC .....	299
19.2 BNC to N .....	300	19.2 BNC auf N .....	300
19.3 BNC to UHF .....	300	19.3 BNC auf UHF .....	300
19.4 BNC to Mini UHF .....	301	19.4 BNC auf Mini-UHF .....	301
19.5 Angle Adaptor BNC to Mini UHF .....	302	19.5 Winkeladapter BNC auf Mini-UHF .....	302
19.6 BNC to 4/13 .....	302	19.6 BNC auf 4/13 .....	302
19.7 BNC to FME .....	302	19.7 BNC auf FME .....	302
19.8 Angle Adaptor BNC to FME .....	303	19.8 Winkeladapter BNC auf FME .....	303
19.9 BNC to SMA .....	304	19.9 BNC auf SMA .....	304
19.10 BNC to SMB .....	305	19.10 BNC auf SMB .....	305
19.11 BNC to 1.6/5.6 .....	306	19.11 BNC auf 1.6/5.6 .....	306
19.12 BNC to F .....	307	19.12 BNC auf F .....	307
19.13 BNC to Cinch .....	307	19.13 BNC auf Cinch .....	307
19.14 TNC to N .....	308	19.14 TNC auf N .....	308
19.15 TNC to UHF .....	309	19.15 TNC auf UHF .....	309
19.16 TNC to Mini-UHF .....	309	19.16 TNC auf Mini-UHF .....	309
19.17 Angle Adaptor TNC to Mini UHF .....	310	19.17 Winkeladapter TNC auf Mini-UHF .....	310
19.18 TNC to FME .....	310	19.18 TNC auf FME .....	310
19.19 Angle Adaptor TNC to FME .....	310	19.19 Winkeladapter TNC auf FME .....	310
19.20 TNC to SMA .....	311	19.20 TNC auf SMA .....	311
19.21 TNC Bulkhead to SMA .....	311	19.21 TNC auf SMA mit Flansch .....	311
19.22 TNC to MCX .....	311	19.22 TNC auf MCX .....	311
19.23 N to Mini UHF .....	312	19.23 N auf Mini-UHF .....	312
19.24 N to FME .....	312	19.24 N auf FME .....	312
19.25 Angle Adaptor N to FME .....	313	19.25 Winkeladapter N auf FME .....	313
19.26 N to SMA .....	313	19.26 N auf SMA .....	313
19.27 UHF to N .....	315	19.27 UHF auf N .....	315
19.28 UHF to Mini UHF .....	316	19.28 UHF auf Mini-UHF .....	316
19.29 UHF to FME .....	316	19.29 UHF auf FME .....	316
19.30 Mini UHF to FME .....	317	19.30 Mini-UHF auf FME .....	317
19.31 Angle Adaptor Mini UHF to FME .....	317	19.31 Winkeladapter Mini-UHF auf FME .....	317
19.32 M to FME .....	317	19.32 M auf FME .....	317
19.33 FME to SMA .....	318	19.33 FME auf SMA .....	318
19.34 SMA to SMB .....	318	19.34 SMA auf SMB .....	318
19.35 7/16 to N .....	319	19.35 7-16 auf N .....	319
19.36 Bulkhead Adaptor R-SMA to U.FL .....	320	19.36 Einbauadapter R-SMA auf U.FL .....	320
19.37 SMA to R-SMA .....	321	19.37 SMA auf R-SMA .....	321
19.38 TNC auf R-TNC .....	321	19.38 TNC auf R-TNC .....	321
19.39 SMA to Push-On SMA .....	322	19.39 SMA auf Push-On SMA .....	322

# Inter-Series Adaptors

## Adapter zwischen den Serien

50 Ohm		BNC		TNC		R-TNC		N		UHF		MiniUHF		M		7-16		4/13		FME		
		m	f	m	f	m	f	m	f	m	f	m	f	m	f	m	f	m	f	m	f	
BNC	m	J01004 A0806	J01004 A0617	J01008 A0011	J01008 B0010				J01008 A0824		* 4		J01008 F0073								* 6	
	f	J01004 A0617	* 1	J01019 B0000	J01008 A0012				J01008 A0825	J01008 A0088	J01008 A0801	* 5	* 13				J01008 A0802		J01008 F0068	J01008 A0070		
TNC	m	J01008 A0011	J01019 B0000	J01014 A2806	J01014 A0001		J01014 R0000		J01019 A0008		J01019 A0003		J01019 F0019								* 7	
	f	J01008 B0010	J01008 A0012	J01014 A0001	* 2	J01014 R0001			J01019 A0007	J01019 A0025	J01019 A0002		* 14									
R-TNC	m				J01014 R0001																	
	f				J01014 R0000																	
N	m		J01008 A0825		J01019 A0007			J01024 J1094	J01024 J1096		J01043 A0831		J01027 F0012			J01122 A0009	* 17				* 8	
	f	J01008 A0824	J01008 A0088	J01019 A0008	J01019 A0025			J01024 J1096	* 3	J01043 A0831		J01027 F0011				J01122 A0008						
UHF	m		J01008 A0801		J01019 A0002				J01043 A0831	J01042 A0653	J01042 F0652		J01043 F0002								J01043 A0000	
	f	* 4	* 5	J01019 A0003				J01043 A0832		J01042 F0652	J01042 A0637	J01043 F0001	J01043 F0000									
MiniUHF	m		* 13		* 14				J01027 F0011		J01043 F0001	J01047 F0000									* 9	
	f	J01008 F0073		J01019 F0019				J01027 F0012		J01043 F0002		J01047 F0001										
M	m																				J01053 A0000	
	f																					
7-16	m							J01122 A0009							J01123 A0000	* 18						
	f							* 17	J01122 A0008						* 18	* 16						
4/13	m		J01008 A0802																			
	f																					
FME	m	* 6	J01008 F0068		* 7					J01043 A0000		* 9		J01053 A0000							* 19	
	f		J01008 A0070																			
SMB	m	J01008 F0038	J01008 F0033																			
	f	J01008 F0030	J01008 F0013																			
SMA	m	J01008 A0018	J01008 A0025		J01019 B0029			J01027 A0019	J01027 A0016												J01703 A0009	
	f	J01008 A0017	J01008 A0019		J01019 A0028			J01027 A0018	* 10												J01703 A0000	
R-SMA	m																					
	f																					
Push-On SMA	m																					
	f																					
MCX	m																					
	f				* 11																	
1.6/5.6	m	J01008 A0810	J01008 A0812																			
	f	J01008 A0813	J01008 A0811																			
Cinch	m		J01008 A0838																			
	f	J01008 A0839																				
F	m		J01008 A0031																			
	f	J01008 A0023	J01008 A0021																			
U.FL	m																					
	f																					

verschiedene Bauformen / various construction types																		
* 1	* 2	* 3	* 4	* 5	* 6	* 7	* 8	* 9	* 10	* 11	* 12	* 13	* 14	* 15	* 16	* 17	* 18	* 19
J01004 A0618	J01014 A2618	J01024 A0004	J01008 A0803	J01008 A0024	J01008 A0014	J01019 A0004	J01027 A0013	J01048 A0000	J01027 A0017	J01019 A0005	J01005 A0006	J01008 F0072	J01019 A0020	J01154 A0001	J01123 A0001	J01122 A0011	J01123 A0004	J01702 A0001
J01004 A1231	J01014 A0004	J01024 A0005			J01008 F0014	J01019 A0012	J01027 A0020	J01048 A0002	J01027 A0008	J01019 A0024	J01005 A1232	J01008 A0074	J01019 F0018	J01154 A001*	J01123 A0002		J01123 A0006	
J01004 A1233	J01014 A2233	J01024 A0006			J01008 A0059			J01048 F0002					J01005 A0007	J01154 A004*	J01123 A0003			
J01004 A1333					J01008 F0059							J01005 A0008		J01123 A0007				
J01004 A0003																		

## Inter-Series Adaptors

### Adapter zwischen den Serien

50 Ohm		SMB		SMA		R-SMA		Push-On SMA		MCX		1.6/5.6		Cinch		F		U.FL	
		m	f	m	f	m	f	m	f	m	f	m	f	m	f	m	f	m	f
BNC	m	J01008 F0038	J01008 F0030	J01008 A0018	J01008 A0017							J01008 A0810	J01008 A0813		J01008 A0839		J01008 A0023		
	f	J01008 F0033	J01008 F0013	J01008 A0025	J01008 A0019							J01008 A0812	J01008 A0811	J01008 A0838		J01008 A0031	J01008 A0021		
TNC	m																		
	f			J01019 B0029	J01019 A0028					* 11									
R-TNC	m																		
	f																		
N	m			J01027 A0019	J01027 A0018														
	f			J01027 A0016	* 10														
UHF	m																		
	f																		
MiniUHF	m																		
	f																		
M	m																		
	f																		
7-16	m																		
	f																		
4/13	m																		
	f																		
FME	m			J01703 A0009	J01703 A0000														
	f																		
SMB	m																		
	f																		
SMA	m			J01154 A0031	J01154 A0021		J01155 R0085												
	f			J01154 A0021	* 15	J01155 R0095		J01155 A0099											
R-SMA	m				J01155 R0095														
	f			J01155 R0085														J01155 R0061	
Push-On SMA	m				J01155 A0099														
	f																		
MCX	m																		
	f																		
1.6/5.6	m											J01074 A1704							
	f												J01074 B1705						
Cinch	m																		
	f																		
F	m																		
	f																		
U.FL	m					J01155 R0061													
	f																		

75 Ohm		BNC		TNC	
		m	f	m	f
BNC	m	J01005 A1230	J01005 A1237		
	f	J01005 A1237	* 12		
TNC	m				
	f			J01015 A2229	

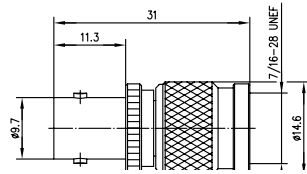

Order No. Bestell-Nr.	Remarks Anmerkungen	Return Loss Return Loss
J01019B0000	f-m Bu-Sti	27 dB/1 GHz; 24 dB/4 GHz

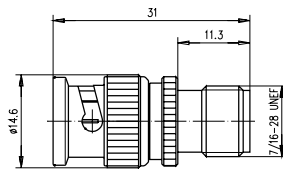

Order No. Bestell-Nr.	Remarks Anmerkungen
J01008B0010	m-f Sti-Bu

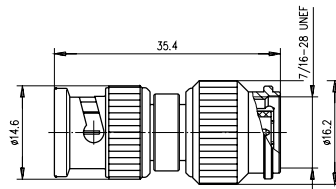

Order No. Bestell-Nr.	Remarks Anmerkungen
J01008A0011	m-m Sti-Sti

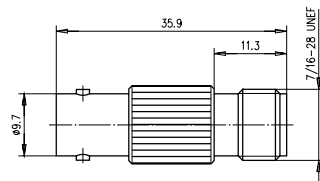

Order No. Bestell-Nr.	Remarks Anmerkungen	Return Loss Return Loss
J01008A0012	f-f Bu-Bu	27 dB/1 GHz; 24 dB/4 GHz

## Inter-Series Adaptors Adapter zwischen den Serien

19.2

### BNC to N BNC auf N

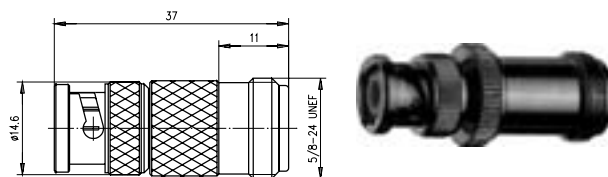

Order No. Bestell-Nr.	Remarks Anmerkungen	Return Loss Return Loss	MIL-Std. MIL-Std.
J01008A0824	m-f Sti-Bu	29 dB/1 GHz; 22,5 dB/4 GHz	UG-349 A/U

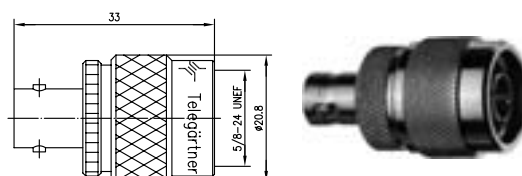

Order No. Bestell-Nr.	Remarks Anmerkungen	Return Loss Return Loss	MIL-Std. MIL-Std.
J01008A0825	f-m Bu-Sti	40 dB/1 GHz; 26 dB/4 GHz	UG-201/U

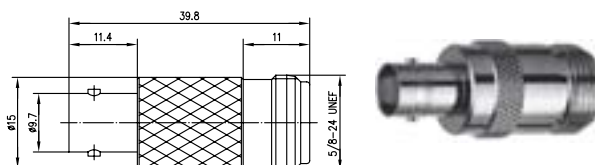

Order No. Bestell-Nr.	Remarks Anmerkungen	Return Loss Return Loss
J01008A0088	f-f TNC-centre contact Ag Bu-Bu, TNC-Innenleiter Ag	34 dB/1 GHz; 26 dB/4 GHz

19.3

### BNC to UHF BNC auf UHF

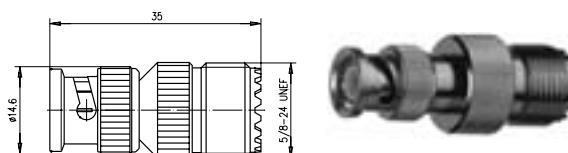

Order No. Bestell-Nr.	Remarks Anmerkungen	MIL-Std. MIL-Std.
J01008A0803	m-f Sti-Bu	UG-255/U

# Inter-Series Adaptors Adapter zwischen den Serien

# 19

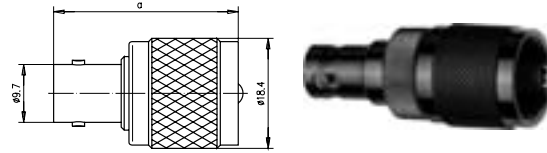

Order No. Bestell-Nr.	Remarks Anmerkungen	Dimensions Abmessungen	MIL-Std. MIL-Std.
J01008A0801	f-m Bu-Sti	a=31	UG-273/U

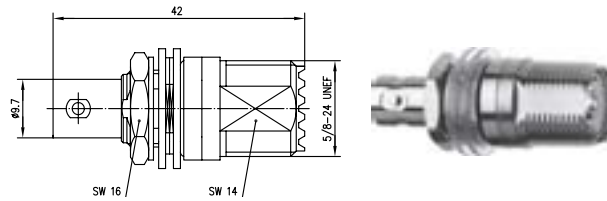

Order No. Bestell-Nr.	Remarks Anmerkungen	Mount. dim. Einbaumaß
J01008A0024	f-f, bulkhead type with insulating washers Bu-Bu, Einbautyp mit Isolierscheiben	Z52

## BNC to Mini UHF BNC auf Mini-UHF

## 19.4

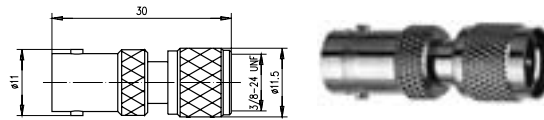

Order No. Bestell-Nr.	Remarks Anmerkungen
J01008F0072	f-m Bu-Sti

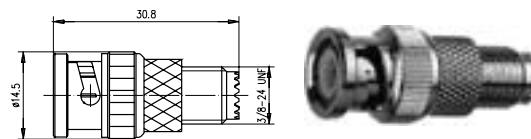

Order No. Bestell-Nr.	Remarks Anmerkungen
J01008F0073	m-f Sti-Bu

## Inter-Series Adaptors Adapter zwischen den Serien

19.5

### Angle Adaptor BNC to Mini UHF Winkeladapter BNC auf Mini-UHF

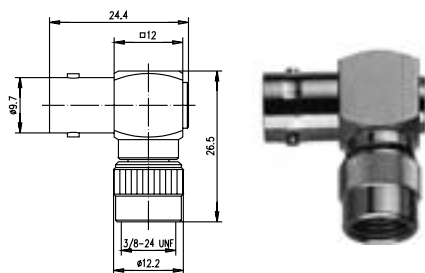

Order No. Bestell-Nr.	Remarks Anmerkungen
J01008A0074	f-m Bu-Sti

19.6

### BNC to 4/13 BNC auf 4/13

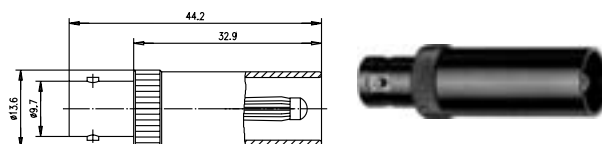

Order No. Bestell-Nr.	Remarks Anmerkungen
J01008A0802	DIN 47283; f-m DIN 47283; Bu-Sti

19.7

### BNC to FME BNC auf FME

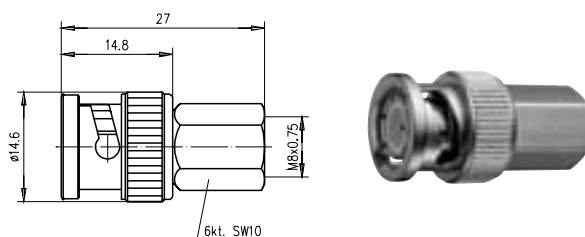

Order No. Bestell-Nr.	Remarks Anmerkungen
J01008A0014	m-m Sti-Sti



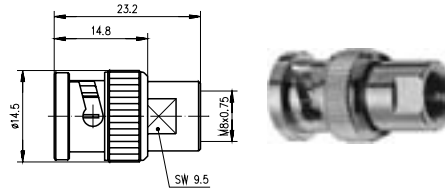

<b>Order No.</b>	<b>Remarks</b>
<b>Bestell-Nr.</b>	<b>Anmerkungen</b>
J01008F0014	m-m, Low cost type Sti-Sti, Low cost type

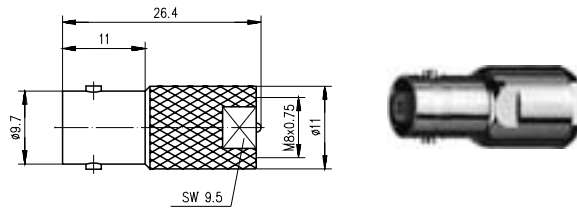

<b>Order No.</b>	<b>Remarks</b>	<b>Return Loss</b>
<b>Bestell-Nr.</b>	<b>Anmerkungen</b>	<b>Return Loss</b>
J01008F0068	f-m Bu-Sti	43 dB/1 GHz; 29 dB/2 GHz

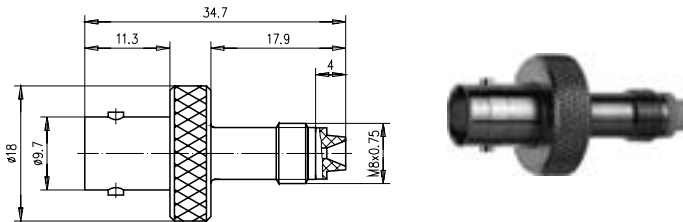

<b>Order No.</b>	<b>Remarks</b>
<b>Bestell-Nr.</b>	<b>Anmerkungen</b>
J01008A0070	f-f Bu-Bu

### Angle Adaptor BNC to FME

### Winkeladapter BNC auf FME

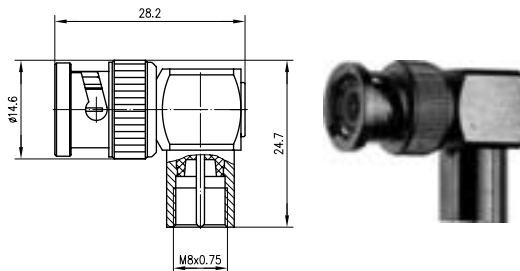

<b>Order No.</b>	<b>Remarks</b>
<b>Bestell-Nr.</b>	<b>Anmerkungen</b>
J01008A0059	m-m Sti-Sti

## Inter-Series Adaptors Adapter zwischen den Serien

19.8

### Angle Adaptor BNC to FME Winkeladapter BNC auf FME

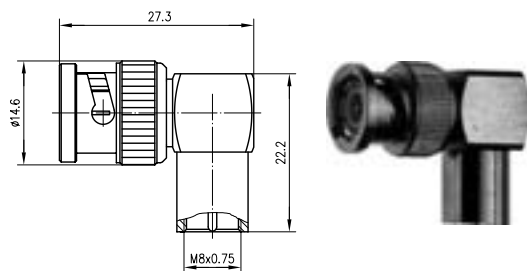

Order No. Bestell-Nr.	Remarks Anmerkungen
J01008F0059	m-m; low-cost type Sti-Sti; low-cost type

19.9

### BNC to SMA BNC auf SMA

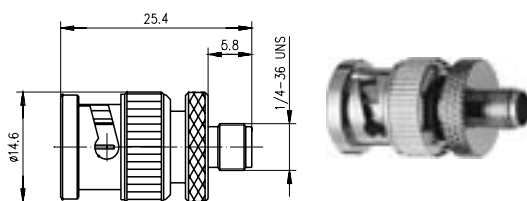

Order No. Bestell-Nr.	Remarks Anmerkungen	Return Loss Return Loss
J01008A0017	m-f Sti-Bu	20 dB/3 GHz

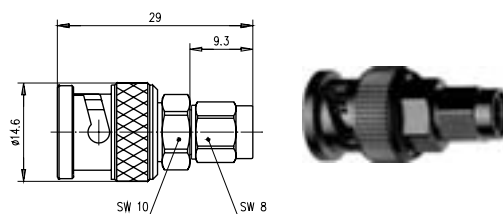

Order No. Bestell-Nr.	Remarks Anmerkungen	Return Loss Return Loss
J01008A0018	m-m Sti-Sti	20 dB/3 GHz

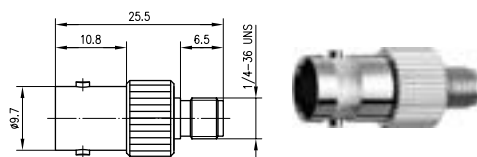

Order No. Bestell-Nr.	Remarks Anmerkungen	Return Loss Return Loss
J01008A0019	f-f Bu-Bu	35,5 dB/1 GHz; 23,5 dB/3 GHz

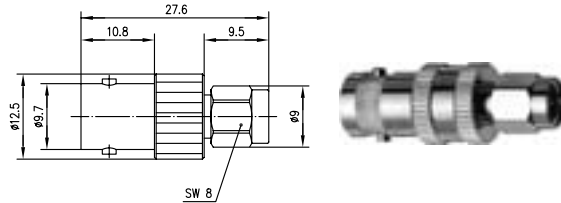

Order No. Bestell-Nr.	Remarks Anmerkungen	Return Loss Return Loss
J01008A0025	f-m Bu-Sti	20 dB/3 GHz

### BNC to SMB BNC auf SMB

19.10

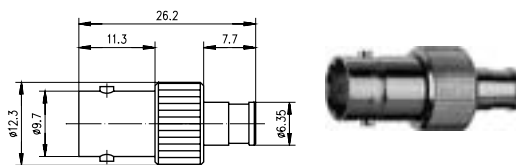

Order No. Bestell-Nr.	Remarks Anmerkungen	Return Loss Return Loss
J01008F0013	f-f Bu-Bu	40 dB/1 GHz; 24 dB/3 GHz

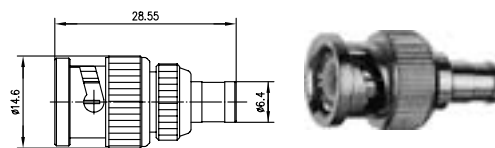

Order No. Bestell-Nr.	Remarks Anmerkungen	Return Loss Return Loss
J01008F0030	m-f Sti-Bu	28 dB/1 GHz; 25.5 dB/3 GHz

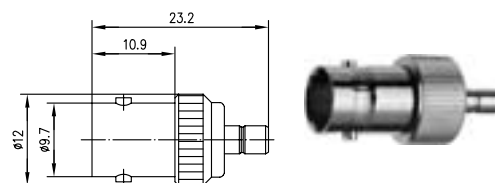

Order No. Bestell-Nr.	Remarks Anmerkungen	Return Loss Return Loss
J01008F0033	f-m Bu-Sti	25 dB/1 GHz; 22 dB/3 GHz

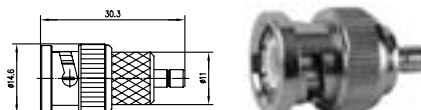

Order No. Bestell-Nr.	Remarks Anmerkungen	Return Loss Return Loss
J01008F0038	m-m Sti-Sti	25 dB/1 GHz; 22 dB/3 GHz

## Inter-Series Adaptors Adapter zwischen den Serien

19.11

**BNC to 1.6/5.6**  
**BNC auf 1.6/5.6**

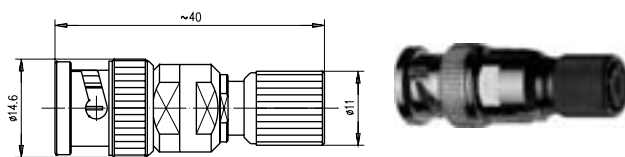

Order No. Bestell-Nr.	Remarks Anmerkungen
J01008A0810	m-m Sti-Sti

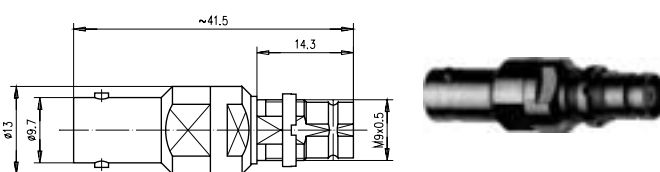

Order No. Bestell-Nr.	Remarks Anmerkungen	Mount. dim. Einbaumaß
J01008A0811	f-f Bu-Bu	Z32

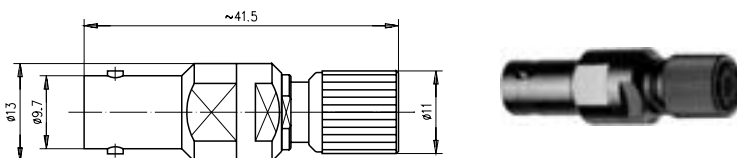

Order No. Bestell-Nr.	Remarks Anmerkungen
J01008A0812	f-m Bu-Sti

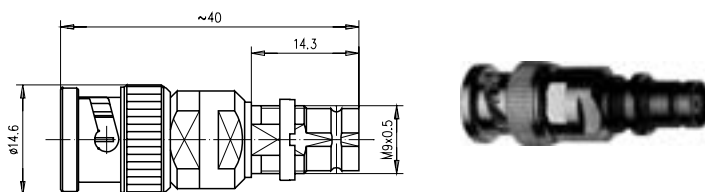

Order No. Bestell-Nr.	Remarks Anmerkungen	Mount. dim. Einbaumaß
J01008A0813	m-f Sti-Bu	Z32

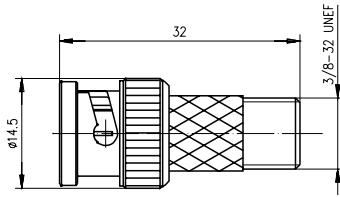

Order No. Bestell-Nr.	Remarks Anmerkungen
J01008A0023	m-f Sti-Bu

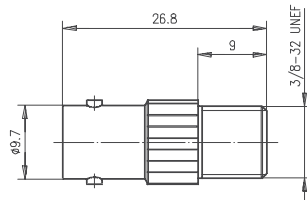

Order No. Bestell-Nr.	Remarks Anmerkungen
J01008A0021	f-f Bu-Bu

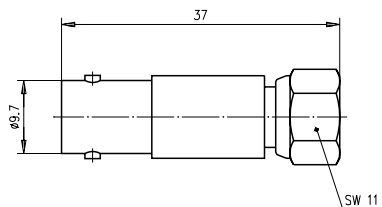

Order No. Bestell-Nr.	Remarks Anmerkungen
J01008A0031	f-m Bu-Sti

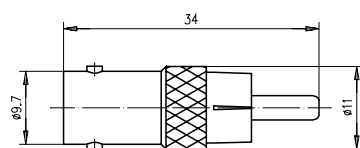

Order No. Bestell-Nr.	Remarks Anmerkungen
J01008A0838	f-m Bu-Sti

## Inter-Series Adaptors Adapter zwischen den Serien

19.13

### BNC to Cinch BNC auf Cinch

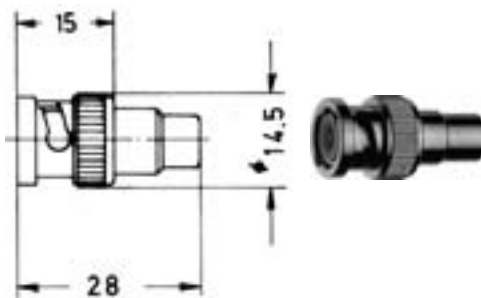

Order No. Bestell-Nr.	Remarks Anmerkungen
J01008A0839	m-f Sti-Bu

19.14

### TNC to N TNC auf N

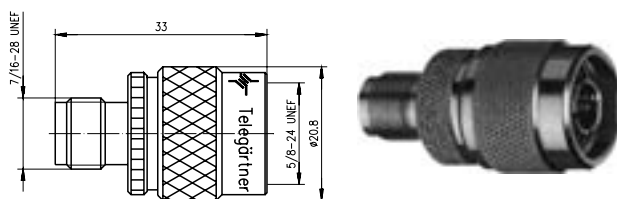

Order No. Bestell-Nr.	Remarks Anmerkungen	Return Loss Return Loss
J01019A0007	f-m Bu-Sti	41,5 dB/1 GHz; 25,5 dB/4 GHz

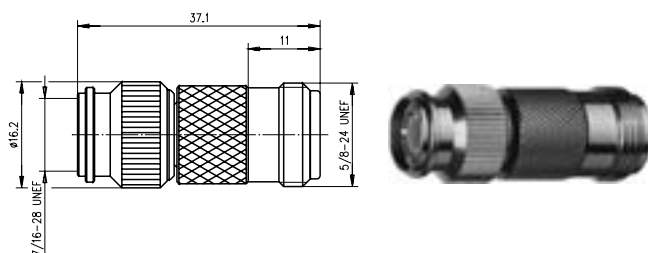

Order No. Bestell-Nr.	Remarks Anmerkungen
J01019A0008	m-f Sti-Bu

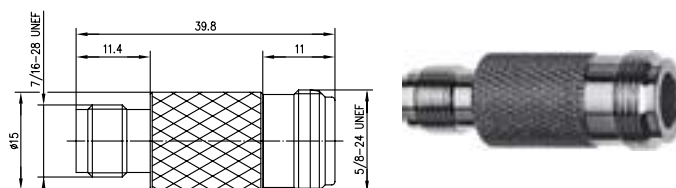

Order No. Bestell-Nr.	Remarks Anmerkungen	Return Loss Return Loss
J01019A0025	f-f Bu-Bu	33 dB/1 GHz; 25 dB/ 6 GHz

# Inter-Series Adaptors

## Adapter zwischen den Serien

# 19

**TNC to UHF**  
TNC auf UHF

19.15

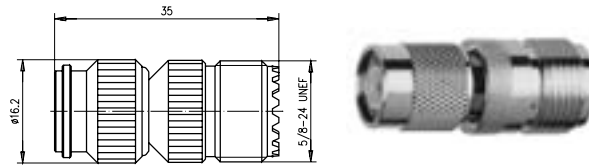

Order No. Bestell-Nr.	Remarks Anmerkungen
J01019A0003	m-f TNC-centre contact Ag Sti-Bu, TNC-Innenleiter Ag

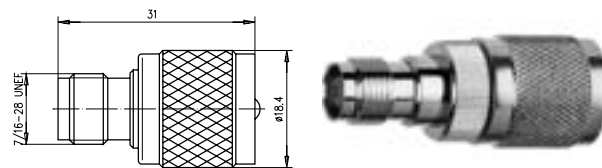

Order No. Bestell-Nr.	Remarks Anmerkungen
J01019A0002	f-m Bu-Sti

**TNC to Mini-UHF**  
TNC auf Mini-UHF

19.16

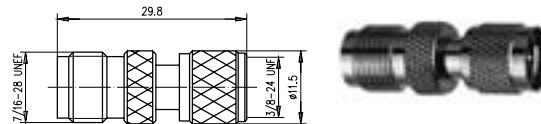

Order No. Bestell-Nr.	Remarks Anmerkungen
J01019F0018	f-m Bu-Sti

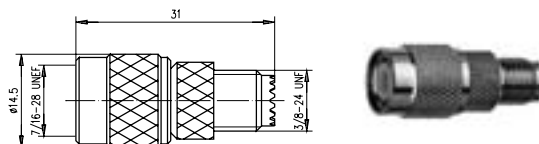

Order No. Bestell-Nr.	Remarks Anmerkungen
J01019F0019	m-f Sti-Bu

## Inter-Series Adaptors Adapter zwischen den Serien

19.17

### Angle Adaptor TNC to Mini UHF Winkeladapter TNC auf Mini-UHF

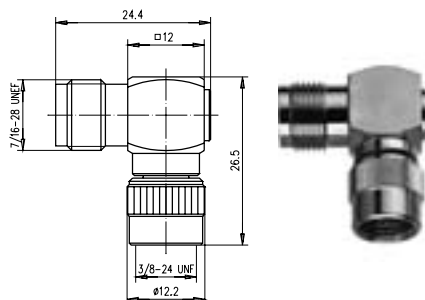

Order No. Bestell-Nr.	Remarks Anmerkungen
J01019A0020	f-m Bu-Sti

19.18

### TNC to FME TNC auf FME

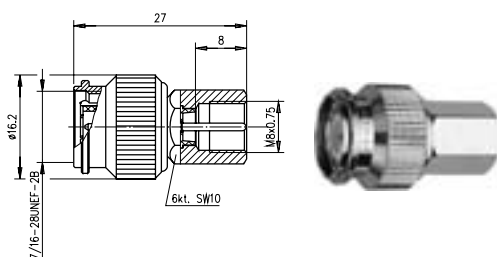

Order No. Bestell-Nr.	Remarks Anmerkungen
J01019A0004	m-m inner conductor Ag Sti-Sti Innenleiter Ag

19.19

### Angle Adaptor TNC to FME Winkeladapter TNC auf FME

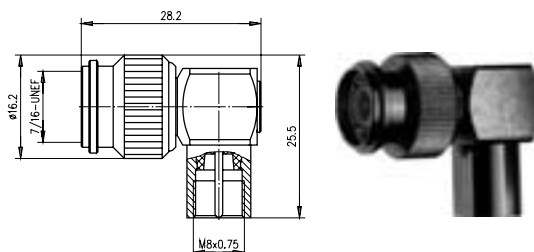

Order No. Bestell-Nr.	Remarks Anmerkungen
J01019A0012	m-m Sti-Sti



# Inter-Series Adaptors

## Adapter zwischen den Serien

# 19

**TNC to SMA**  
TNC auf SMA

19.20

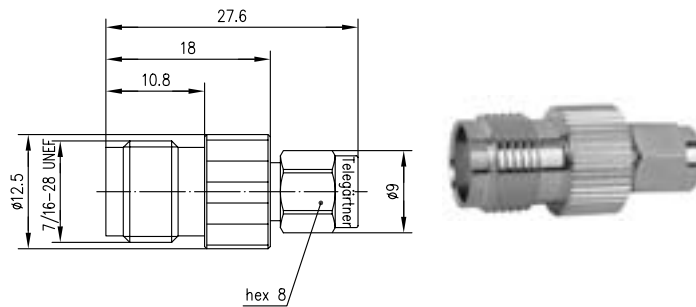

Order No. Bestell-Nr.	Remarks Anmerkungen
J01019B0029	f-m Bu-Sti

**TNC Bulkhead to SMA**  
TNC auf SMA mit Flansch

19.21

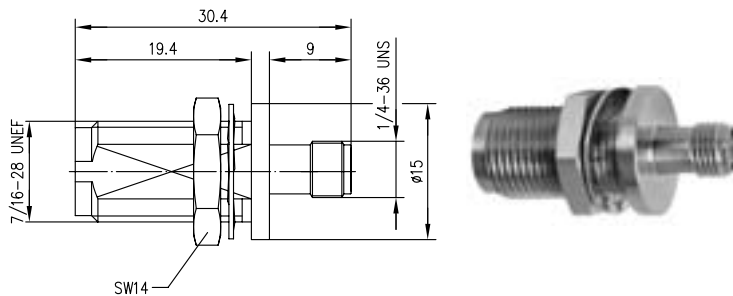

Order No. Bestell-Nr.	Remarks Anmerkungen	Mount. dim. Einbaumaß
J01019A0028	f-f; bulkhead adaptor; housing in stainless steel Bu-Bu; Einbautype; Gehäuse in rostfreiem Stahl	Z03

**TNC to MCX**  
TNC auf MCX

19.22

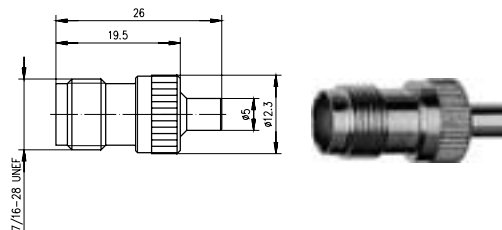

Order No. Bestell-Nr.	Remarks Anmerkungen
J01019A0024	f-f Bu-Bu

## Inter-Series Adaptors Adapter zwischen den Serien

19.23

### N to Mini UHF N auf Mini-UHF

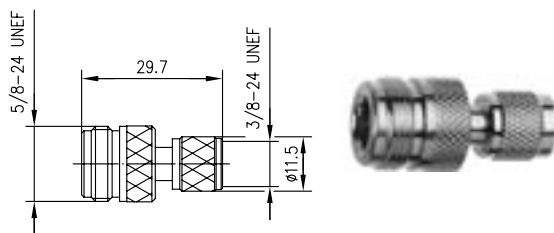

<b>Order No.</b>	<b>Remarks</b>
<b>Bestell-Nr.</b>	<b>Anmerkungen</b>
J01027F0011	f-m Bu-Sti

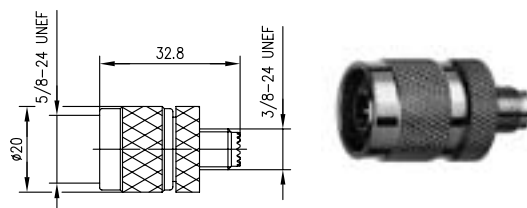

<b>Order No.</b>	<b>Remarks</b>
<b>Bestell-Nr.</b>	<b>Anmerkungen</b>
J01027F0012	m-f Sti-Bu

19.24

### N to FME N auf FME

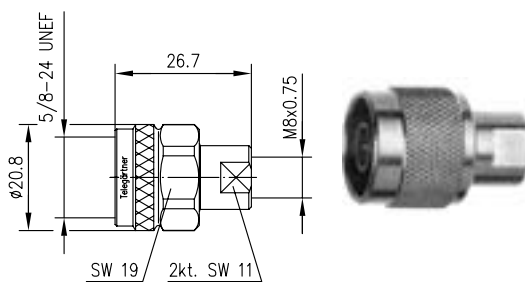

<b>Order No.</b>	<b>Remarks</b>	<b>Return Loss</b>
<b>Bestell-Nr.</b>	<b>Anmerkungen</b>	<b>Return Loss</b>
J01027A0013	m-m Sti-Sti	28 dB/1.8 GHz

### Angle Adaptor N to FME Winkeladapter N auf FME

19.25

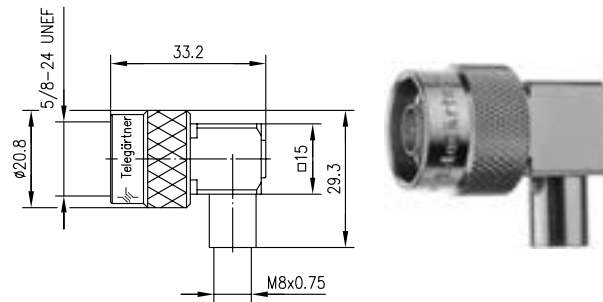

Order No. Bestell-Nr.	Remarks Anmerkungen	Return Loss Return Loss
J01027A0020	m-m Sti-Sti	25 dB/1.8 GHz

### N to SMA N auf SMA

19.26

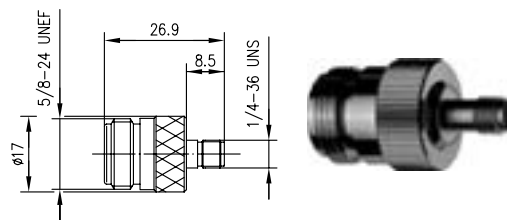

Order No. Bestell-Nr.	Remarks Anmerkungen	Return Loss Return Loss
J01027A0017	f-f Bu-Bu	42 dB/1 GHz; 26 dB/6 GHz

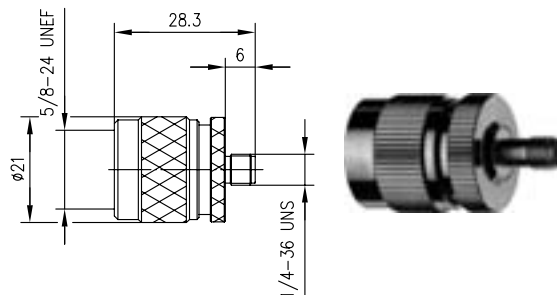

Order No. Bestell-Nr.	Remarks Anmerkungen	Return Loss Return Loss
J01027A0018	m-f Sti-Bu	37 dB/1 GHz; 23 dB/6 GHz

19.26

## Inter-Series Adaptors Adapter zwischen den Serien

19.26

### N to SMA N auf SMA

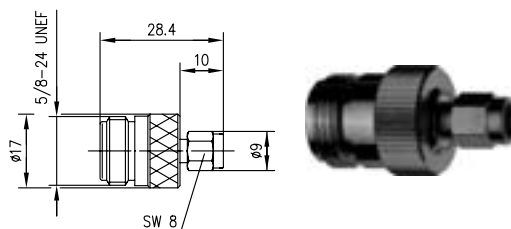

Order No. Bestell-Nr.	Remarks Anmerkungen	Return Loss Return Loss
J01027A0016	f-m Bu-Sti	38 dB/1 GHz; 21 dB/6 GHz

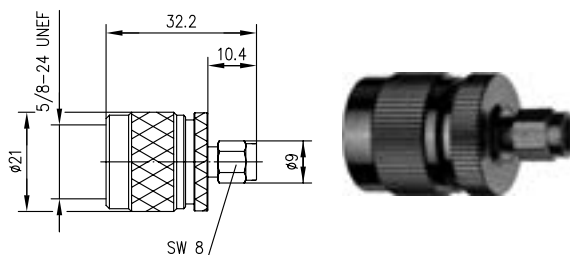

Order No. Bestell-Nr.	Remarks Anmerkungen	Return Loss Return Loss
J01027A0019	m-m Sti-Sti	39 dB/1 GHz; 25 dB/6 GHz

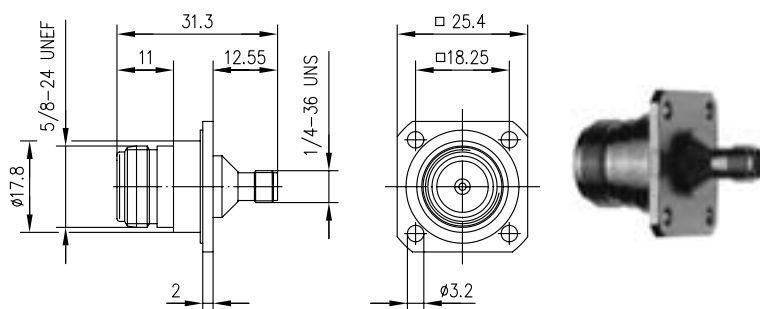

Order No. Bestell-Nr.	Remarks Anmerkungen	Mount. dim. Einbaumaß	Return Loss Return Loss
J01027A0008	f-f panel Bu-Bu mit Flansch	Z53	33 dB/1 GHz; 22 dB/4 GHz

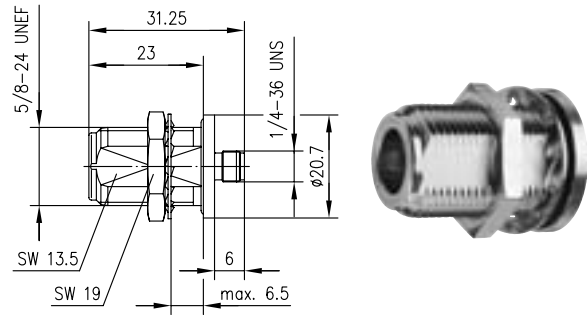

Order No. Bestell-Nr.	Remarks Anmerkungen	Mount. dim. Einbaumaß
J01027A0022	f-f bulkhead adaptor Bu-Bu Einbaudapter	Z10

### UHF to N UHF auf N

19.27

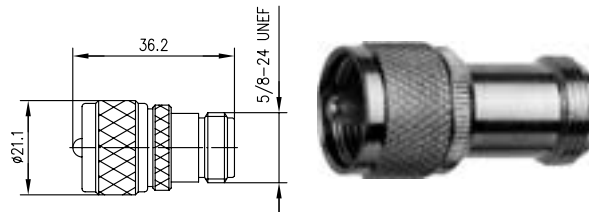

Order No. Bestell-Nr.	Remarks Anmerkungen	MIL-Std. MIL-Std.
J01043A0831	m-f Sti-Bu	UG-83 B/U

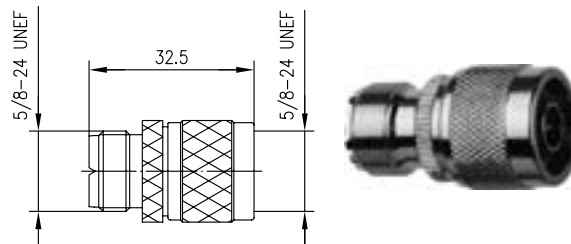

Order No. Bestell-Nr.	Remarks Anmerkungen	MIL-Std. MIL-Std.
J01043A0832	f-m Bu-Sti	UG-146 /U

## Inter-Series Adaptors Adapter zwischen den Serien

19.28

### UHF to Mini UHF UHF auf Mini-UHF

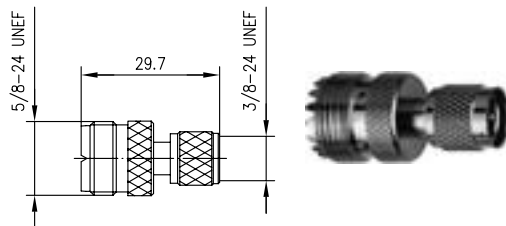

Order No. Bestell-Nr.	Remarks Anmerkungen
J01043F0001	f-m Bu-Sti

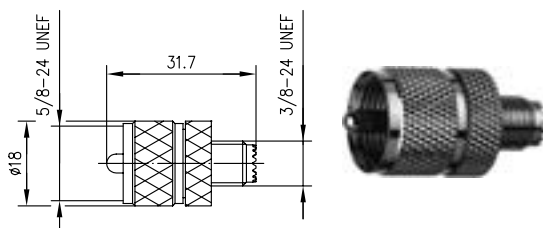

Order No. Bestell-Nr.	Remarks Anmerkungen
J01043F0002	m-f Sti-Bu

19.29

### UHF to FME UHF auf FME

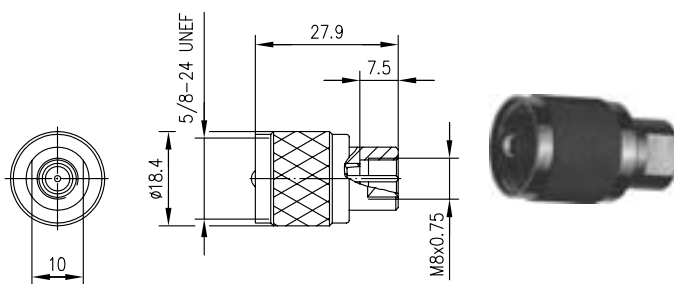

Order No. Bestell-Nr.	Remarks Anmerkungen
J01043A0000	m-m Sti-Sti

# Inter-Series Adaptors

## Adapter zwischen den Serien

# 19

**Mini UHF to FME**  
**Mini-UHF auf FME**

19.30

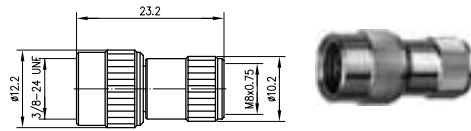

Order No. Bestell-Nr.	Remarks Anmerkungen
J01048A0000	m-m Sti-Sti

**Angle Adaptor Mini UHF to FME**  
**Winkeladapter Mini-UHF auf FME**

19.31

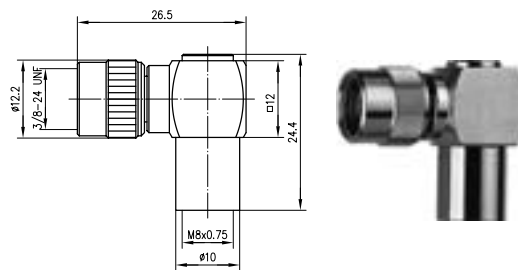

Order No. Bestell-Nr.	Remarks Anmerkungen
J01048A0002	m-m Sti-Sti

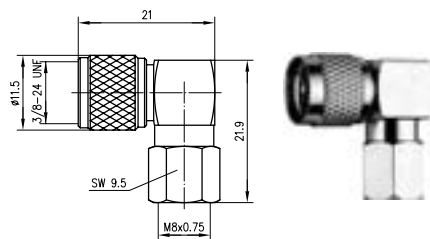

Order No. Bestell-Nr.	Remarks Anmerkungen
J01048F0002	m-m Sti-Sti

**M to FME**  
**M auf FME**

19.32

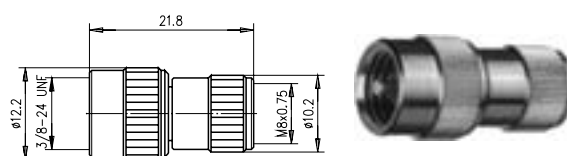

Order No. Bestell-Nr.	Remarks Anmerkungen
J01053A0000	m-m Sti-Sti

## Inter-Series Adaptors Adapter zwischen den Serien

19.33

### FME to SMA FME auf SMA

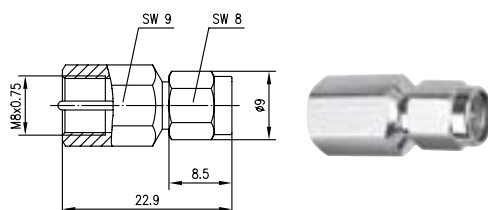

Order No. Bestell-Nr.	Remarks Anmerkungen
J01703A0009	m-m Sti-Sti

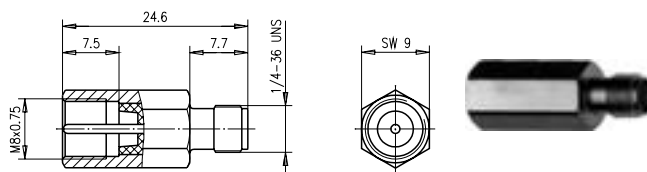

Order No. Bestell-Nr.	Remarks Anmerkungen
J01703A0000	m-f Sti-Bu

19.34

### SMA to SMB SMA auf SMB

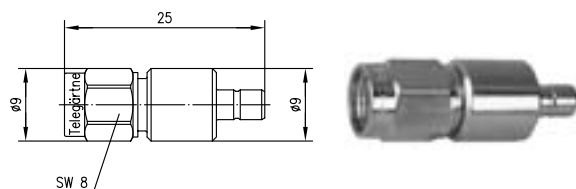

Order No. Bestell-Nr.	Remarks Anmerkungen	Return Loss Return Loss
J01155A0021	m-m Sti-Sti	32 dB/1 GHz; 25 dB/4 GHz

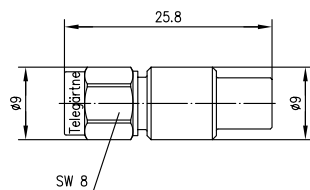

Order No. Bestell-Nr.	Remarks Anmerkungen	Return Loss Return Loss
J01155A0031	m-f Sti-Bu	32 dB/1 GHz; 25 dB/4 GHz



# Inter-Series Adaptors

## Adapter zwischen den Serien

# 19

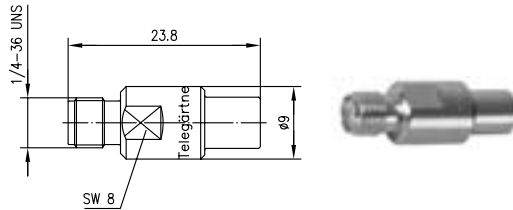

Order No. Bestell-Nr.	Remarks Anmerkungen	Return Loss Return Loss
J01155A0041	f-f Bu-Bu	32 dB/1 GHz; 25 dB/4 GHz

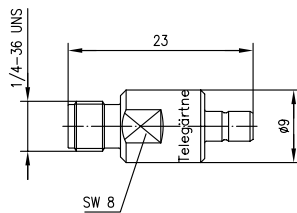

Order No. Bestell-Nr.	Remarks Anmerkungen	Return Loss Return Loss
J01155A0051	f-m Bu-Sti	32 dB/1 GHz; 25 dB/4 GHz

**7/16 to N**  
**7-16 auf N**

19.35

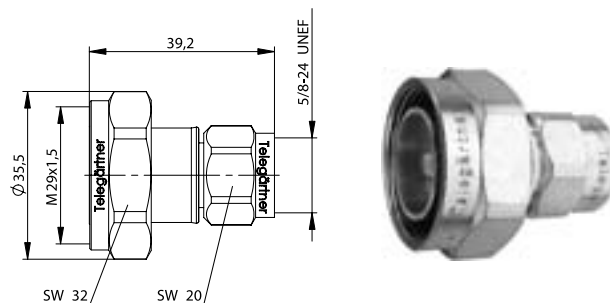

Order No. Bestell-Nr.	Remarks Anmerkungen	Return Loss Return Loss
J01122C0009	m-m Sti-Sti	44.5 dB/1 GHz; 32 dB/6 GHz

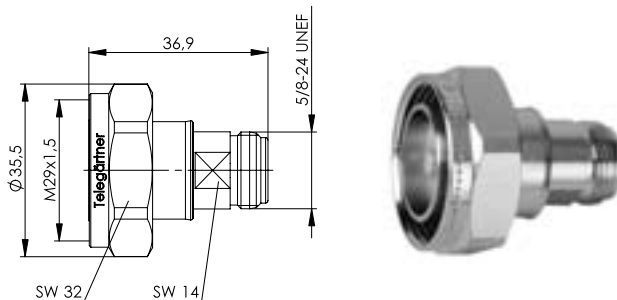

Order No. Bestell-Nr.	Remarks Anmerkungen	Return Loss Return Loss
J01122B0010	m-f Sti-Bu	44.5 dB/1 GHz; 32 dB/6 GHz

19.35

## Inter-Series Adaptors Adapter zwischen den Serien

19.35

**7/16 to N**  
**7-16 auf N**

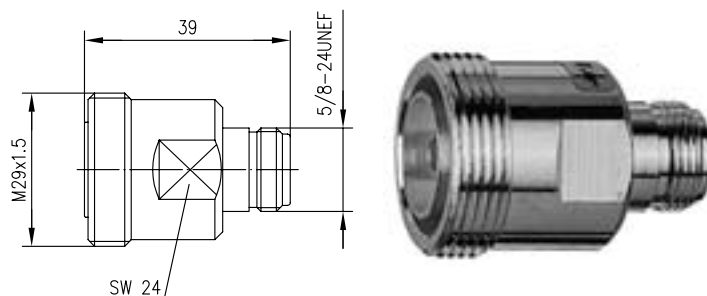

Order No. Bestell-Nr.	Remarks Anmerkungen	Return Loss Return Loss
J01122A0008	f-f Bu-Bu	44 dB/1 GHz, 40 dB/2.5 GHz, 32 dB/6 GHz

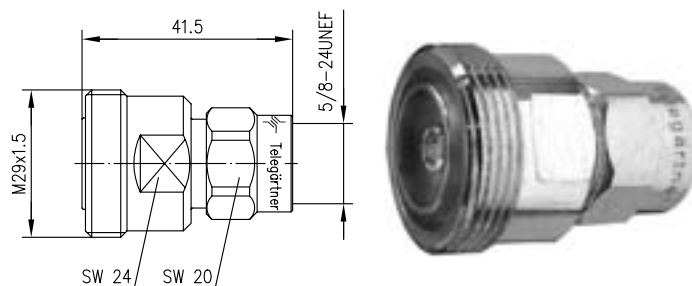

Order No. Bestell-Nr.	Remarks Anmerkungen	Return Loss Return Loss
J01122A0011	f-m Bu-Sti	44 dB/1 GHz, 40 dB/2.5 GHz, 32 dB/6 GHz

19.36

**Bulkhead Adaptor R-SMA to U.FL**  
**Einbauadapter R-SMA auf U.FL**

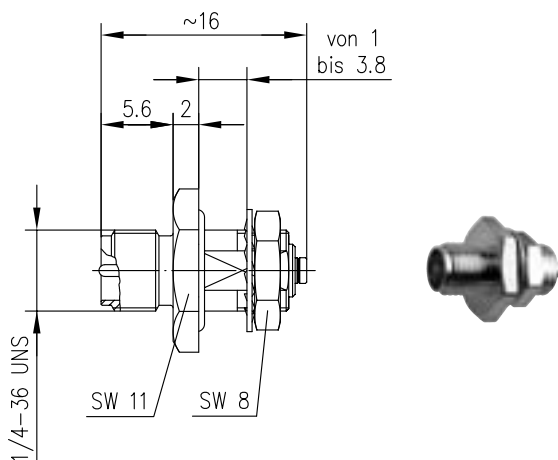

Order No. Bestell-Nr.	Remarks Anmerkungen	Mount. dim. Einbaumaß
J01155R0061	f reverse - m Bu reverse - Sti	Z36

# Inter-Series Adaptors

## Adapter zwischen den Serien

# 19

**SMA to R-SMA**  
**SMA auf R-SMA**

19.37

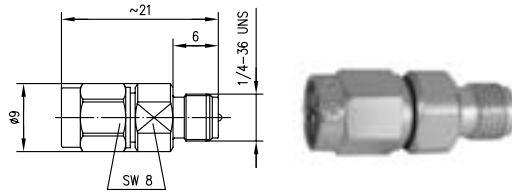

Order No. Bestell-Nr.	Remarks Anmerkungen
J01155R0085	m-f reverse Sti-Bu reverse

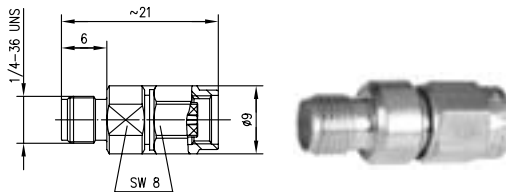

Order No. Bestell-Nr.	Remarks Anmerkungen
J01155R0095	f-m reverse Bu-Sti reverse

**TNC auf R-TNC**  
**TNC auf R-TNC**

19.38

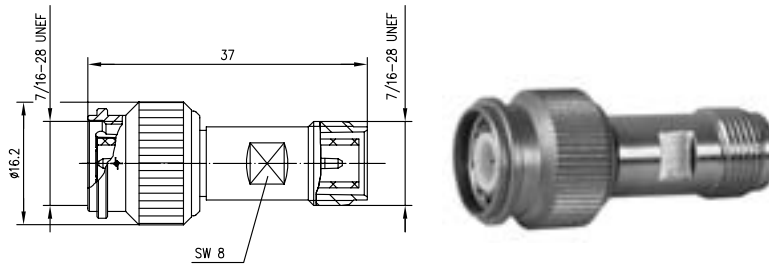

Order No. Bestell-Nr.	Remarks Anmerkungen
J01014R0000	m-f reverse Sti-Bu reverse

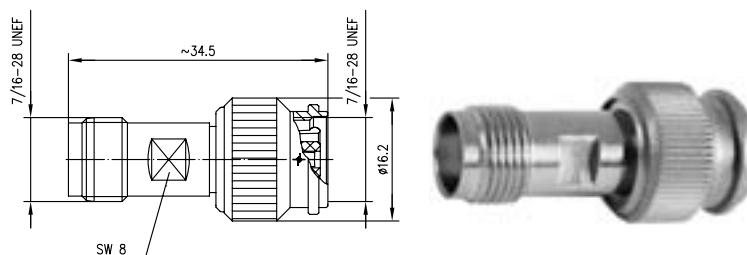

Order No. Bestell-Nr.	Remarks Anmerkungen
J01014R0001	f-m reverse Bu-Sti reverse

# Inter-Series Adaptors

## Adapter zwischen den Serien

19.39

### SMA to Push-On SMA

#### SMA auf Push-On SMA

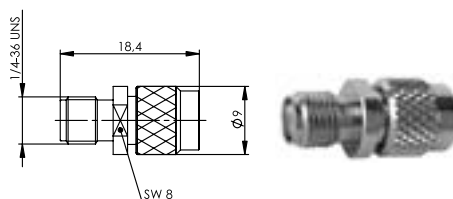
**Order No.****Bestell-Nr.**

J01155A0099

**Remarks****Anmerkungen**

f-m push-on; connection is made by pushing male side on a standard SMA jack; ideal for fast and repeated connections  
 Bu-Sti push on; Verbindung auf der Stecker-Seite durch einfaches Aufschieben auf Standard SMA-Buchsen; ideal für schnelles und häufiges Anschließen