



Locating emissions of a few hundred microseconds

Using state-of-the-art digital technology, direction finders from Rohde & Schwarz detect any signal from 300 kHz to 3 GHz. Even extremely brief emissions of only 400 μ s (e.g. GSM) will be intercepted and DFed. Due to the implementation of various DF methods, the direction finders can be optimally matched to any application.

We offer a complete program

- ◆ For land-based, airborne or shipboard use
- ◆ Portable sets as well as stationary search DF systems
- ◆ SSL (single station location) DF systems for the HF range

When it comes to intercepted DFed frequency hopping networks, our fast digital search direction finders and receivers featuring synchronous scanning stand every test.

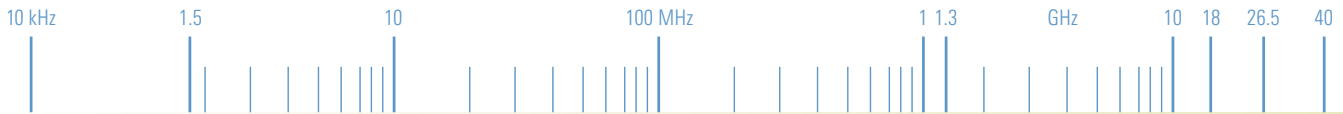

Contents of Chapter 3

Type	Designation	Page
	Introduction into Theory of Direction Finding	60
R&S®DDF0xA/E	Digital Direction Finders	84
R&S®DDF0xA/E	Digital Direction Finders – Specifications	91
R&S®DDFx	Options for the R&S®DDF0xA/E Family	94
R&S®ADDx	DF Antennas	100
R&S®DDF195	Digital Direction Finder	106
R&S®DDF100M	Digital Direction Finder for Traffic Control	110

Direction Finders

Contents Overview

Type Index

Main Menu

Direction Finders

R&S® DDF0xA/

R&S® DDF0xE

Digital Direction Finders

0.3 MHz to 3000 MHz

R&S® DDF0xA digital HF/VHF/UHF

scanning direction finder

R&S® DDF0xE digital HF/VHF/UHF

monitoring direction finder

Main features

- ◆ Outstanding accuracy and sensitivity
- ◆ Superior receiver performance
- ◆ Excellent large signal immunity
- ◆ Algorithms for correlative interferometer and Watson-Watt as standard
- ◆ Super-resolution algorithm as option

R&S® DDF0xA only

- ◆ Wide instantaneous bandwidth of approx. 10 MHz
- ◆ Highest DF scan speed of up to 30 GHz/s (correlative interferometer)

R&S® DDF0xE only

- ◆ Wide instantaneous bandwidth of 2 MHz (option: approx. 10 MHz)
- ◆ High DF scan speed of up to 2 GHz/s (option: 10 GHz/s)



Brief description

The digital HF/VHF/UHF wideband direction finders of the R&S® DDF0xA/E family feature outstanding performance and are highly versatile.

The R&S® DDF0xA/E family of direction finders sets new standards in several ways:

- ◆ Multielement DF antennas with particularly wide aperture for high DF accuracy, DF sensitivity and immunity to reflections
- ◆ Complex and high-quality receivers for excellent large-signal immunity and large interference-free dynamic range
- ◆ Three-channel interception processing channel for particularly fast calculation of bearings and high probability of intercept for short-duration signals
- ◆ Compact design for mobile platforms and fast changes of location

3

Chapter
Overview

Type
Index

Main
Menu

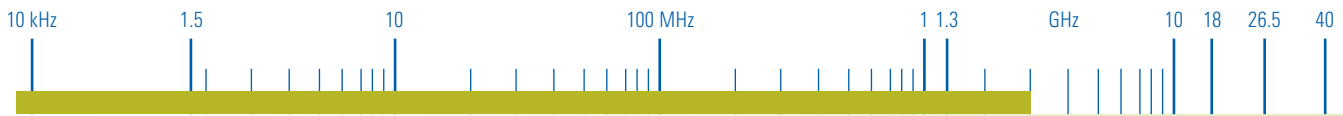

Direction Finders: R&S®DDF0xA/R&S®DDF0xE Digital Direction Finders

The R&S®DDF0xA/E family of wideband direction finders covers the frequency range from 0.3 MHz to 3000 MHz and can optionally be expanded up to 9 kHz. The direction finders use digital signal processing both for filtering and calculating bearings.

Each direction finder consists of four functional units:

- ◆ DF antenna system
- ◆ Three-channel DF receiver (converter)
- ◆ Digital signal processing unit
- ◆ Control PC with software

The algorithms required to perform an evaluation in accordance with the Watson-Watt method and the correlative interferometer are implemented as standard in the signal processing unit.

Digital DF methods

The acronym DDF in the type designation stands for digital direction finder, indicating that bearings are determined digitally, i.e. the complex antenna voltages are measured and digitized by a high-quality three-channel DF receiver that acts like a vector analyzer. The bearings are evaluated using mathematical algorithms. Both the "classic" Watson-Watt method and the modern correlative interferometer can be used. The super-resolution algorithm is available as an option.

The Watson-Watt method is preferably used in the HF range in cases where only limited space is available for setting up a DF antenna (e.g. on ships).

The correlative interferometer has the following advantages over classic methods:

- ◆ Optimum DF accuracy
- ◆ Reduction of DF errors caused by reflections and depolarization
- ◆ Determination of a reliable DF quality criterion for evaluating and filtering bearings
- ◆ Possibility of using wide-aperture DF antennas with a minimum number of antenna elements (preferably a circular array)

By using fast Fourier transform (FFT), the digital processing unit also makes it possible to scan wider frequency ranges for activities; this is done at high speed.

R&S®DDF0xA and R&S®DDF0xE

The R&S®DDF0xA/E wideband direction finders are based on the same DF antennas and DF receivers. For this reason, some technical characteristics such as DF accuracy, DF sensitivity and large-signal immunity are identical.

The main difference between the R&S®DDF0xA and the R&S®DDF0xE is the processing speed.

R&S®DDF0xA – fast scan for short-duration signals

Since the R&S®DDF0xA scanning direction finder is optimized for the direction finding of short-duration signals at unknown frequencies, it has a far higher calculation capacity than the R&S®DDF0xE monitoring direction finder. For this reason, the scan speed and the POI have considerably been increased. The minimum signal duration in the VHF/UHF range is lower.

R&S®DDF0xE – for demanding requirements in radio detection

The R&S®DDF0xE monitoring direction finder is a wideband direction finder of outstanding performance in the field of radio detection. It meets the ITU requirements and even exceeds most of them. It thus handles demanding jobs in both mobile and stationary operation.

Operating and display concept

The DF converter and the digital processing unit do not have control and display elements as standard. The direction finder is operated from a powerful external PC (with Windows XP) via Fast Ethernet. Each direction finder comes with a software package that contains the graphical user interface (GUI) and optional software modules such as the single station locator (SSL) for the shortwave range or GSM direction finding. Four DF modes are available:

Fixed frequency mode (FFM)

In this mode, the direction finder is operated at a fixed frequency. The bearing is displayed in analog (polar) and digital format. Alternatively, the bearing can be displayed in histogram/waterfall format. For each bearing, the receive level and a quality value (0 to 100) are displayed. In addition to the bearing, the realtime spectrum is displayed, centered to the receive frequency that has been set. The bandwidths for the DF process and the audio demodulation can be set independently of each other.

Search mode

In this mode, either a frequency range (defined by start/stop frequency and step width) or a frequency list (with up to 1000 entries) is searched for activities. If the direction finder detects a signal that exceeds a predefined threshold, it dwells on this signal for a selectable length of time. Bearings are presented in the same way as in the fixed frequency mode.

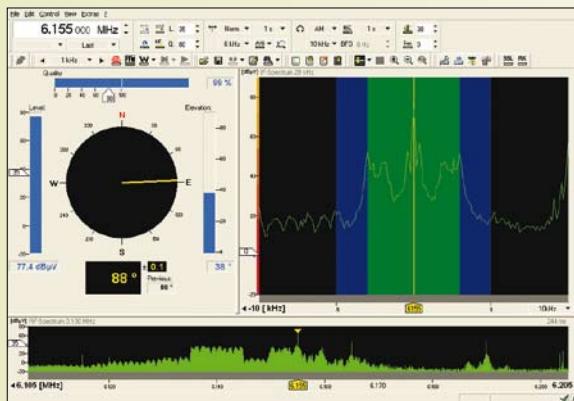

Fixed frequency mode (FFM), search mode

Scan mode (fast DF scanning)

The R&S®DDF0xA/E family of direction finders also offers the capability to scan defined frequency ranges at a selectable step width (frequency scan) or up to 1000 stored frequency channels (memory scan) for activities. DF results can be displayed in several ways: Basically, all information is shown in a spectral display, i.e. versus frequency. Bearings are displayed in the azimuth versus frequency mode and can be color-coded according to age, level or azimuth. To reduce data, it is also possible to define azimuth sectors or level and elevation ranges. Specific frequencies can be labeled with scales or markers. Simply by clicking the mouse, the user can then switch to the FFM menu for closer analysis of the selected signal.

Wideband mode (WFFM)

In this mode, the direction finder simultaneously takes bearings of all channels that fall within the FFT realtime bandwidth. All relevant parameters such as channel spacing, integration time, and DF quality threshold can be directly set. Results can be displayed in several formats, e.g. spectrum display, bearing versus frequency, and waterfall format.

The WFFM mode in addition offers the innovative feature of parallel averaging of all channels by coherent integration, which significantly enhances the probability of obtaining bearings of weak signals. Even DSSS signals within the noise floor are reliably detected and their bearings taken.

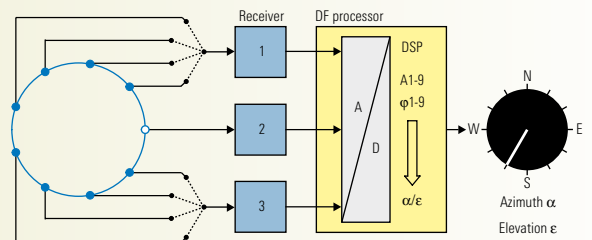

Block diagram of the R&S®DDF0xA/E family

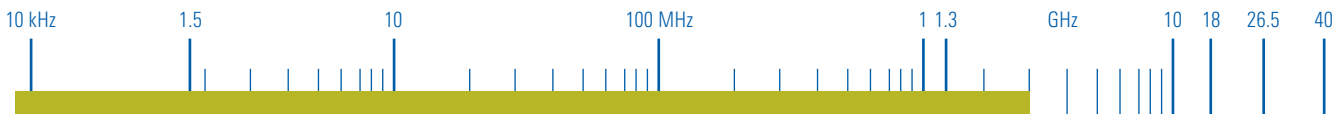

Direction Finders: R&S®DDF0xA/R&S®DDF0xE Digital Direction Finders

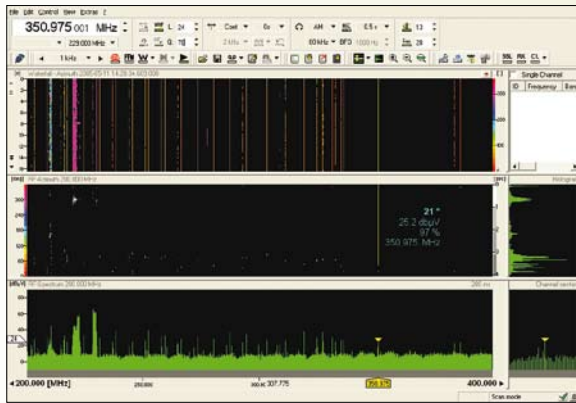

Scan mode

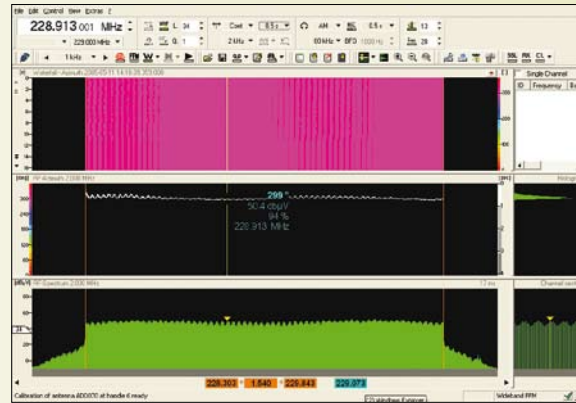

Wideband mode (WFFM)

3

Background information

DF scan speed and channel selectivity

When specifying the DF scan speed, it is essential to indicate the selectivity conditions under which the speed is attained. As a basic rule, the lower the channel selectivity, the higher the speed. With lower selectivity, however, adjacent channel suppression may be insufficient, and adjacent occupied channels may mutually influence the respective bearings that are taken. Selectivity is characterized by the shape factor, which indicates the ratio of the bandwidth at 60 dB suppression to the bandwidth at 3 dB suppression of the unwanted adjacent channel. The R&S®DDF0xA/E family has a shape factor of 3.6 in the scan mode. A quantity connected with the shape factor is the product of the measurement time T and the bandwidth B ($B \times T$ or BT). The R&S®DDF0xA/E family has a $B \times T$ of 4 to achieve the desired selectivity characteristics.

DF scan speed and channel occupancy

The R&S®DDF0xA/E family is one of the very few direction finders available that offers DF scan speed independent of channel occupancy. In other words, the DF scan speed of the direction finder does not vary and is maintained even with 100 % channel occupancy. With most conventional direction finders, the DF scan speed decreases rapidly as the channel occupancy increases. For this reason, DF scan speed is usually specified for only 10 % channel occupancy.

This value is quickly exceeded, however, when bearings of weak signals close to the noise floor are taken or of direct sequence spread spectrum (DSSS) signals within the noise floor.

DF scan speed and channel resolution

The DF scan speed mainly depends on the selected channel resolution. The lower the resolution, the shorter the filter settling time and the higher the DF scan speed. It is therefore important to specify the DF scan speed together with the channel resolution.

Number of antenna elements

In principle, DF antennas with a larger number of antenna elements can be designed for larger diameters. But using a larger number of antenna elements offers clear advantages even for DF antennas that have identical diameters. For example, a nine-element DF antenna provides higher accuracy and error tolerance than a five-element antenna due to the fact that it delivers nearly twice as many antenna signals to be correlated.

Chapter Overview

Type Index

Main Menu

DF accuracy and sensitivity

When the R&S®DDF0xA/E family is tested in a real environment, it is impressive for the stable and accurate bearings it delivers even for weak signals. This fact is due to the direction finder's elaborate design concept, which is described in the following.

The direction finder was planned from the start with high accuracy and sensitivity in mind. Consequently, the decision was made in favor of the concept of virtual receivers, which offers significant advantages with respect to the aforementioned prerequisites.

The concept of virtual receivers is characterized by a large number of antenna elements being successively connected to a small number of receivers at very high speed, creating the impression that each antenna element is assigned a receive path of its own. The decisive advantage is that large DF antennas with many antenna elements can be used without requiring a corresponding number of receive paths, which would be very costly, because the larger the size of a DF antenna, the more antenna elements are required.

It is generally known that a direction finder's accuracy and sensitivity in a real environment increase with the diameter of the DF antenna. As already mentioned, this advantage comes into its own only in a real operational environment, which involves reflections and weak signals. It is not obvious from specifications, since in data sheets the instrument and system accuracy are specified for ideal, non-reflecting DF antenna environments and strong signals to provide comparability.

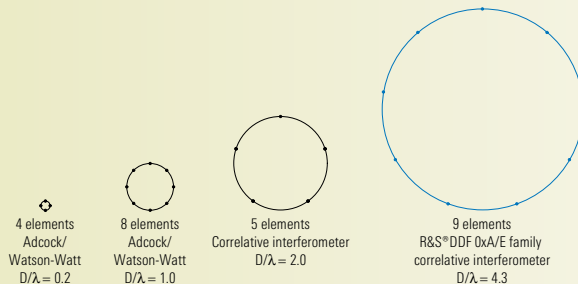

Maximum permissible diameter of the DF antenna relative to the wavelength for unambiguous DF results for up to 50% of environmental reflections

The figure at the bottom shows that the R&S®DDF0xA/E family, featuring a nine-element array and employing the correlative interferometer DF method, offers by far the largest DF antenna and thus higher accuracy and sensitivity.

The figure below shows the improvement in DF accuracy as a function of the DF antenna aperture.

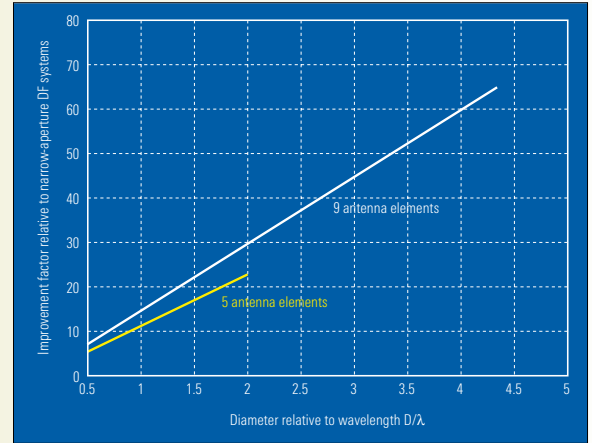

Improvement factor as a function of the DF antenna aperture for the correlative interferometer

The enhanced accuracy and sensitivity of the R&S®DDF0xA/E family makes it especially suitable for taking bearings

- ◆ of weak signals
- ◆ of spread spectrum or DSSS signals within the noise floor
- ◆ with high accuracy even in non-ideal antenna environments
- ◆ in extremely adverse environments, e.g. urban areas

By using averaging during broadband direction finding, a function currently unrivaled, the R&S®DDF0xA/E family reliably detects and takes bearings of signals such as DSSS even if they occur within the noise floor. The R&S®DDF0xA/E family is thus well prepared for this type of data transmission, which is becoming more and more common.

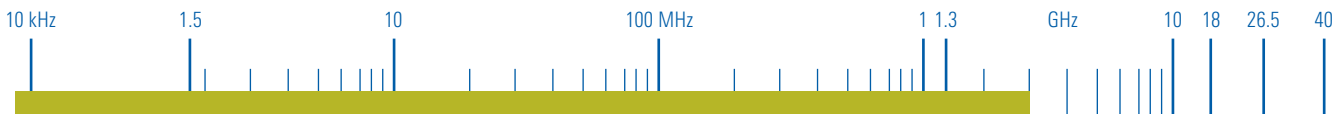

Direction Finders: R&S®DDF0xA/R&S®DDF0xE Digital Direction Finders

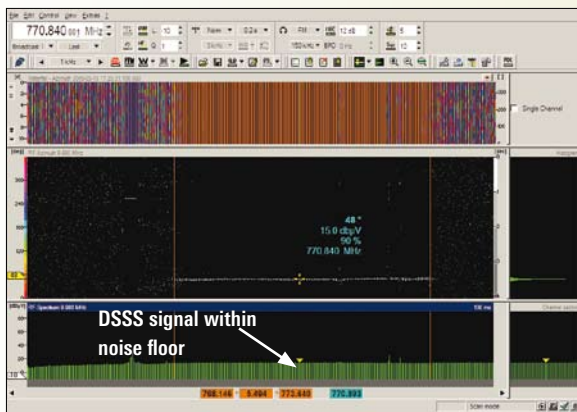

DSSS signal within noise floor (-6 dB)

The figure above shows a bearing being taken of a DSSS signal within the noise floor (-6 dB), the signal having a width of approx. 5.5 MHz and a nominal bearing value of 48°. The DSSS signal is not recognizable in the spectrum as the signal-to-noise ratio is negative. The very narrow bearing histogram indicates very low bearing fluctuation and thus a reliable bearing value.

The R&S®DDF0xA/E family is also remarkable for its sensitivity: From HF to 1.3 GHz, a low field strength of typically 0.2 µV/m (HF) to 1 µV/m (VHF/UHF) will suffice to obtain a stable bearing. Above 1.3 GHz, no more than 3 µV/m to 10 µV/m is needed. This makes the R&S®DDF0xA and R&S®DDF0xE one of the most sensitive direction finders available on the market, which is also due to its high number of antenna elements.

The higher the sensitivity, the wider the range of a direction finder. This is shown by the figure above, which compares two DF systems of different sensitivity. The comparison is based on the equations for radio propagation in the VHF range recommended by ITU. According to these equations, the R&S®DDF05A/E reliably determines the bearing of a 1 W VHF transmitter with a line of sight up to a distance of typically 30 km. For a DF system of lower sensitivity, the distance has to be reduced, and just a few µV/m already mean a significant reduction in DF range.

The high sensitivity of the R&S®DDF0xA/E family provides significantly wider coverage. This means that fewer direction finders are needed for monitoring a specific area than would be in the case of less sensitive DF systems, although sensitivity may differ by just a few µV/m.

This substantially reduces costs, as can be seen from the figure below.

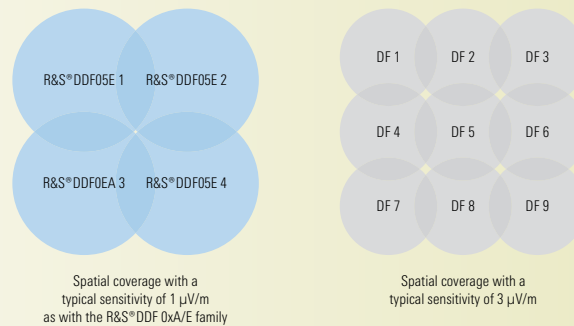

Coverage comparison of DF systems of different sensitivity

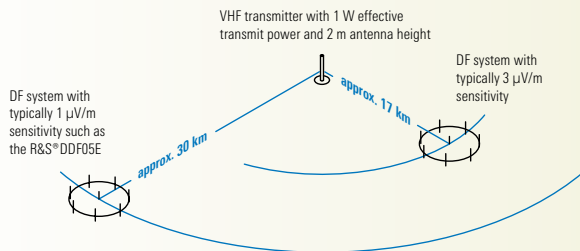

Range comparison of DF systems of different sensitivity for a VHF transmission

Immunity to reflections

Reflections may basically impair DF accuracy. Depending on their concept, some DF antennas can handle reflections better than others. The R&S®DDF0xA/E family was designed to provide accurate bearings even with a 50 % share of reflections of the incoming signal. This high immunity to reflections is due to the large number of antenna elements used.

DF sensitivity

At present, there exists no uniform method of measuring and specifying DF sensitivity. It is therefore of vital importance that precise information be provided about the measurement method employed. Specifying DF sensitivity without giving any information about the measurement method by which the specified sensitivity was obtained is meaningless, as different methods will produce significantly different results. For Rohde & Schwarz products, DF sensitivity is defined as the minimum field strength required by the direction finder together with the DF antenna in order to yield accurate bearings.

Receiver quality

Whether weak signals can be received at all or whether a direction finder can deliver meaningful results, even when located at an unfavorable site in the vicinity of a strong transmitter, largely depends on the quality of the receivers used.

Linearity, which is defined by the second- and third-order intercept (SOI and TOI) points, describes to what extent intermodulation products in the vicinity of strong transmitters become visible. Unfortunately, standardized procedures for measuring SOI and TOI are not yet available. This makes it difficult to compare the quality of different receivers on the basis of data sheet specifications. Where comparable measurements are available, the R&S®DDF0xA/E receivers frequently have significantly higher and thus better values.

The very low phase noise additionally increases immunity to strong signals.

And here another advantage of the virtual receiver concept comes into play: the fact that only a small number of receive paths is required. The DF converters of the R&S®DDF0xA/E family contain three coherent receive paths. Compared with five-path direction finders, this concept alone reduces costs by 40 %. This in turn makes it possible to use receivers of superior quality.

Each R&S®DDF0xA and R&S®DDF0xE version is equipped with three receivers that are among the best available on the world market and have been developed and produced by Rohde & Schwarz itself:

- ◆ The converter for the HF range contains three receivers nearly identical in design with the R&S®EM010
- ◆ The converter for the VHF/UHF range contains three receivers nearly identical in design with the R&S®EM050

Finding a suitable location for a DF antenna is often difficult, in particular in the VHF/UHF range, because strong transmitters, e.g. FM or TV broadcast transmitters, may be located nearby. The R&S®DDF0xA/E's high linearity and very low phase noise make it possible to install the direction finder closer to strong transmitters.

Simulations show that, with intermodulation products of equal strength, the R&S®DDF0xA/E family can be located approx. 30 % closer to a strong transmitter than a direction finder whose intercept points are approx. 10 dB lower. Compared with a direction finder with 18 dB lower intercept points, the R&S®DDF0xA/E family can be installed at even half the distance. This facilitates finding a suitable DF antenna site.

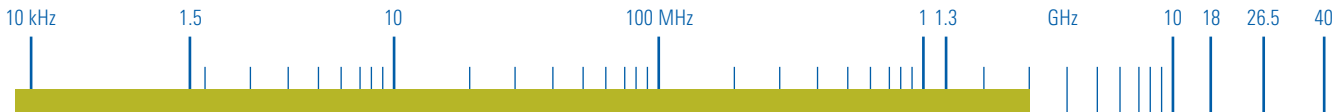

Specifications of the R&S® DDF0xA

Frequency range	
R&S® DDF01A	0.3 MHz to 30 MHz
With R&S® DDF-LF	
option	9 kHz to 30 MHz
R&S® DDF05A	20 MHz to 3000 MHz
With R&S® DDFA-WB	
option	0.3 MHz to 3000 MHz
Instrument DF accuracy	0.5° RMS
System DF accuracy (in test field)	
R&S® DDF01A	
With R&S® ADD010 or	
R&S® ADD011	1° RMS
R&S® DDF05A	
With R&S® ADD053	
option	1° RMS
With R&S® ADD070	
option	2° RMS
DF sensitivity	
R&S® DDF01A	typ. 0.2 µV/m to 0.5 µV/m (see diagram for HF DF antennas, page 101)
R&S® DDF05A	
20 MHz to 1300 MHz	typ. 0.5 µV/m to 1 µV/m
1300 MHz to 3 GHz	typ. 3 µV/m to 10 µV/m (see diagram for VHF/UHF DF antennas, page 101)
Instantaneous bandwidth	
R&S® DDF01A	1 MHz
10 MHz (6 dB)/5 MHz/2 MHz with	
R&S® DDFA-WB option	
R&S® DDF05A	10 MHz (–6 dB)
Minimum signal duration ¹⁾ (depending on selected FFT realtime bandwidth)	
Correlative interferometer	
R&S® DDF01A	1 ms
R&S® DDF05A	350 µs
Watson-Watt	
R&S® DDF01A	0.3 ms
R&S® DDF05A	150 µs
Scan speed with 20 kHz resolution, 100 % channel occupancy, B × T = 4	
Correlative interferometer	
R&S® DDF01A	up to 0.9 GHz/s (incl. calculation of elevation)
With R&S® DDFA-WB	
option	up to 4 GHz/s (incl. calculation of elevation)
Watson-Watt	
R&S® DDF01A	up to 3.5 GHz/s
With R&S® DDFA-WB	
option	up to 11 GHz/s

Scan speed with 200 kHz resolution, 100 % channel occupancy, B × T = 4	
Correlative interferometer	
R&S® DDF05A	up to 30 GHz/s
Watson-Watt	
R&S® DDF05A	up to 80 GHz/s
Dynamic range (incl. AGC) >120 dB	
Linearity	
SOI	
R&S® DDF01A	≥75 dBm, typ. 85 dBm
R&S® DDF05A	≥50 dBm, typ. 63 dBm
TOI	
R&S® DDF01A ²⁾	≥32 dBm, typ. 39 dBm
R&S® DDF05A ³⁾	≥18 dBm, typ. 28 dBm
Intermodulation-free dynamic range	
R&S® DDF01A	typ. 95 dB (in-band, bandwidth of 1.2 kHz)
R&S® DDF05A	typ. 85 dB (in-band, bandwidth of 7.5 kHz)
Phase noise	
R&S® DDF01A	<–110 dBc (1 Hz) at 1 kHz offset
typ. –116 dBc (1 Hz) at 1 kHz offset	
R&S® DDF05A	<–116 dBc (1 Hz) at 10 kHz offset
typ. –120 dBc (1 Hz) at 10 kHz offset	
Image frequency rejection	
R&S® DDF01A	>95 dB, typ. 110 dB
R&S® DDF05A	>90 dB, typ. 110 dB
IF rejection	
>95 dB, typ. 110 dB	

Specifications of the R&S® DDF0xE

Frequency range	
R&S® DDF01E	0.3 MHz to 30 MHz
With R&S® DDF-LF	
option	9 kHz to 30 MHz
R&S® DDF05E	20 MHz to 3000 MHz
With R&S® DDFA-WB	
option	0.3 MHz to 3000 MHz
Instrument DF accuracy	0.5° RMS

²⁾ Frequency separation between intermodulating signals ≥30 kHz. Higher values are possible for measurements performed at larger frequency separation.

³⁾ Frequency separation between intermodulating signals ≥2.2 MHz. Higher values are possible for measurements performed at larger frequency separation.

¹⁾ 100 % probability of intercept for a single burst emission within realtime bandwidth. Lower values are possible for measurements performed with multiple burst emissions and reduced probability of intercept.

System DF accuracy (in test field)	
R&S®DDF01E	
With R&S®ADD010 or	
R&S®ADD011	1° RMS
R&S®DDF05E	
With R&S®ADD053	1° RMS
With R&S®ADD070	2° RMS
DF sensitivity	
R&S®DDF01E	typ. 0.2 µV/m to 0.5 µV/m (see diagram for HF DF antennas, page 101)
R&S®DDF05E	
20 MHz to 1300 MHz	typ. 0.5 µV/m to 1 µV/m
1300 MHz to 3 GHz	typ. 3 µV/m to 10 µV/m (see diagram for VHF/UHF DF antennas, page 101)
Instantaneous bandwidth	
R&S®DDF01E	1 MHz
R&S®DDF05E	2 MHz
With R&S®DDFE-HBW	
option	10 MHz (–6 dB)
Minimum signal duration ⁴⁾ (depending on selected FFT realtime bandwidth)	
Correlative interferometer	
R&S®DDF01E	1 ms
R&S®DDF05E	400 µs
Watson-Watt	
R&S®DDF01E	0.3 ms
R&S®DDF05E	150 µs
Scan speed with 20 kHz resolution, 100 % channel occupancy, B × T = 4	
Correlative interferometer	
R&S®DDF01E	up to 450 MHz/s (incl. calculation of elevation)
With R&S®DDFA-WB	
option	up to 4 GHz/s (incl. calculation of elevation)
Watson-Watt	
R&S®DDF01E	up to 1700 MHz/s
Scan speed with 100 kHz resolution, 100 % channel occupancy, B × T = 4	
Correlative interferometer	
R&S®DDF05E	5.7 GHz/s
With R&S®DDFE-HBW	
option	10 GHz/s
Watson-Watt	
R&S®DDF05E	20 GHz/s
Dynamic range (incl. AGC) >120 dB	

⁴⁾ 100 % probability of intercept for a single burst emission within realtime bandwidth. Lower values are possible for measurements performed with multiple burst emissions and reduced probability of intercept.

Linearity	
SOI	
R&S®DDF01E	≥75 dBm, typ. 85 dBm
R&S®DDF05E	≥50 dBm, typ. 63 dBm
TOI	
R&S®DDF01E ⁵⁾	≥32 dBm, typ. 39 dBm
R&S®DDF05E ⁶⁾	≥18 dBm, typ. 28 dBm
Intermodulation-free dynamic range	
R&S®DDF01E	typ. 95 dB (in-band, bandwidth of 1.2 kHz)
R&S®DDF05E	typ. 85 dB (in-band, bandwidth of 7.5 kHz)
Phase noise	
R&S®DDF01E	<–110 dBc (1 Hz) at 1 kHz offset typ. –116 dBc (1 Hz) at 1 kHz offset
R&S®DDF05E	<–116 dBc (1 Hz) at 10 kHz offset typ. –120 dBc (1 Hz) at 10 kHz offset
Image frequency rejection	
R&S®DDF01E	>95 dB, typ. 110 dB
R&S®DDF05E	>90 dB, typ. 110 dB
IF rejection	
	>95 dB, typ. 110 dB

General data

Valid for the R&S®DDF0xA/E family

Operating	
temperature range	–10 °C to +55 °C, in line with EN 60068-2-1, EN 60068-2-2, MIL-STD-810E Meth. 501.3/502.3
Storage	
temperature range	–40 °C to +71 °C, in line with EN 60068-2-1, EN 60068-2-2, MIL-STD-810E Meth. 501.3/502.3
Humidity/damp heat	max. 80 % cycl. test at +25 °C/+40 °C, in line with EN 60068-2-30 max. 95 % rel. humidity, without condensation, in line with MIL-STD-810E Meth. 507.3, without cyclic condensation
Mech. resistance/shock	30 g, 11 ms semi-sinewave, in line with EN 60068-2-27 40 g shock spectrum, 45 Hz to 200 Hz, in line with MIL-STD-810E, Meth. 516.4

⁵⁾ Frequency separation between intermodulating signals ≥30 kHz. Higher values are possible for measurements performed at larger frequency separation.

⁶⁾ Frequency separation between intermodulating signals ≥2.2 MHz. Higher values are possible for measurements performed at larger frequency separation.

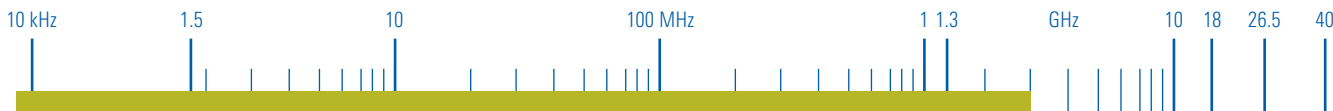

Direction Finders: R&S®DDF0xA/R&S®DDF0xE Digital Direction Finders – Specifications

Vibration		Power supply	100 V to 230 V AC, +10%/-12%, 47 Hz to 63 Hz
Sinusoidal	5 Hz to 55 Hz, max. 2 g, 55 Hz to 150 Hz, 0.5 g const., 12 min/(3)axis, in line with EN 60068-2-6	Electrical safety	(in line with EN 61010, VDE 0411)
Random	10 Hz to 500 Hz, 1.9 g RMS, 30 min/(3)axis, in line with EN 60068-2-64	R&S®EBD061	max. 350 VA, typ. 250 VA
EMC	30 MHz to 1000 MHz, 30/37 dBµV/m, field strength (emission), in line with EN 55022	R&S®EBD660	max. 350 VA, typ. 300 VA
	0.15 MHz to 30 MHz, class B interference voltage on AC power lines, in line with EN 55022	R&S®EH110	max. 150 VA, typ. 120 VA
	0 Hz to 2 kHz interference current on AC power lines, in line with EN 61000-3-2	R&S®ET550	max. 200 VA, typ. 180 VA
	±8 kV/±4 kV static discharge, in line with EN 61000-4-2	Dimensions	
	80 MHz to 1000 MHz, 10 V/m field strength (immunity), in line with EN 61000-4-3	(W × H × D)	436 mm × 192 mm × 460 mm (17.17 in × 7.56 in × 18.11 in) (19" × 4 height units)
	±2 kV/±1 kV transient burst at AC power/ signal connection (immunity), in line with EN 61000-4-4	Weight	
	±2 kV/±1 kV burst (immunity), in line with EN 61000-4-5	R&S®EBD061	approx. 15 kg (33.07 lb)
	0.15 MHz to 80 MHz, 10 V unmod./mod. 80% AM (1 kHz) on lines, in line with EN 61000-4-6	R&S®EBD660	approx. 15 kg (33.07 lb)
	10 ms/30%, 100 ms/60% voltage reduction, 5 s voltage interruption on AC power lines, in line with EN 61000-4-11	R&S®EH110	approx. 16 kg (35.27 lb)
		R&S®ET550	approx. 18 kg (39.68 lb)

Ordering information

Digital HF Scanning		
Direction Finder	R&S®DDF01A	4059.9100.02
Digital VHF/UHF Scanning		
Direction Finder	R&S®DDF05A	4059.9200.02
Digital HF/VHF/UHF Scanning Direction		
Finder	R&S®DDF06A	4059.9300.02
Digital HF Monitoring		
Direction Finder	R&S®DDF01E	4059.9600.02
Digital VHF/UHF Monitoring		
Direction Finder	R&S®DDF05E	4059.9700.02
Digital HF/VHF/UHF Monitoring Direction		
Finder	R&S®DDF06E	4059.9800.02
Antennas	R&S®ADDx	see page 100

Options		
Master Slave Handover	R&S®RA-MSH	3020.9690.02
LF Extension	R&S®DDF-LF	4060.0348.02
HF Wideband Module	R&S®DDFA-WB	4060.0248.02
GSM Interception	R&S®DDF-GSM	4059.9951.02
Synchronous Scanning	R&S®DDF-TS	4060.0290.02
Raw-Data Recording	R&S®DDF-DR	4060.0390.02
Preclassifier	R&S®DDF-CL	4059.9900.02
Single Station Locator for HF	R&S®DDF-SSL	3020.8864.02
Remote Control Extension High-Frequency	R&S®DDFA-REM	3020.8858.02
Resolution	R&S®DDF-HFR	on request
Service Kit (for maintenance and troubleshooting)	R&S®DDF-SK	4060.0454.02
Geographic Information Software	R&S®MapView	4046.1105.02
HF Extension for R&S®DDF05E	R&S®DDFE-HF	on request
High Bandwidth	R&S®DDFE-HBW	4066.8992.02

R&S®DDF_x – options for the R&S®DDF0_xA/E family

Direction finding of GSM mobile phones (R&S®DDF-GSM option)

With this option, the R&S®DDF05A/E family enables quasi-simultaneous direction finding of all mobile phones active in a channel. A bearing is determined for each occupied timeslot. Only in this way is it possible to locate a mobile phone in a densely occupied radio scenario.

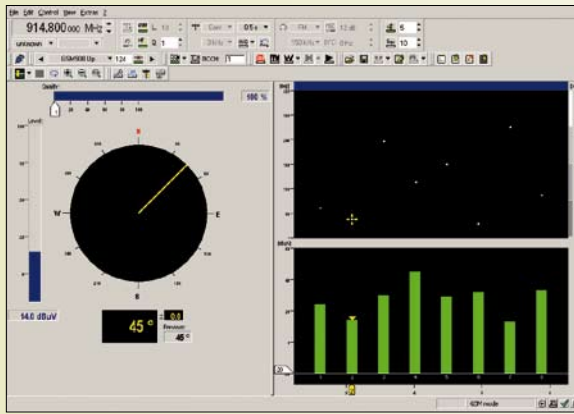

R&S®DDF-GSM option: control software in GSM mode with eight mobile phones

Mobile phones transmit information in short bursts of 577 μ s. Requiring a minimum signal duration of only 400 μ s, the R&S®DDF05A/E family is able to capture these extremely short-term emissions. The main task of the GSM option is to cause the direction finder to start the measurement exactly when the mobile phone starts transmitting. This can be done in three ways:

- ◆ The R&S®DDF05A/E family is synchronized to the base station to which the mobile phone is connected
- ◆ An external trigger signal informs the R&S®DDF05A/E family of the start of an emission
- ◆ The R&S®DDF05A/E family is supplied with a highly stable clock signal (e.g. GPS) and synchronized to the base station only once. Depending on the stability of the external clock signal, the direction finder remains synchronized to the base station for many hours

Automatic preclassifier (R&S®DDF-CL option)

Personnel involved in military radiomonitring in particular has to cope with increasingly complex radio scenarios. The spectrum occupancy is steadily increasing, while the techniques employed to camouflage radio emissions are becoming more and more sophisticated.

Consequently, the probability increases that, for example, frequency hoppers operating in large bandwidths or short bursts emitted at unknown frequencies will go unnoticed.

The preclassifier ensures that virtually every signal will be detected.

After a start and a stop frequency is entered, the frequency range is continuously scanned and results are stored. Any new signals detected are compared with the results previously stored. If a specific pattern is recognized (e.g. several burst emissions from the same direction, indicating a frequency hopper), the signal in question is classified as belonging to one of the following categories: fixed frequency, hopper, chirp or burst. Individual results are averaged to form an overall result. The preclassifier option, therefore, provides the basic functionality needed for the automatic location of LPI signals.

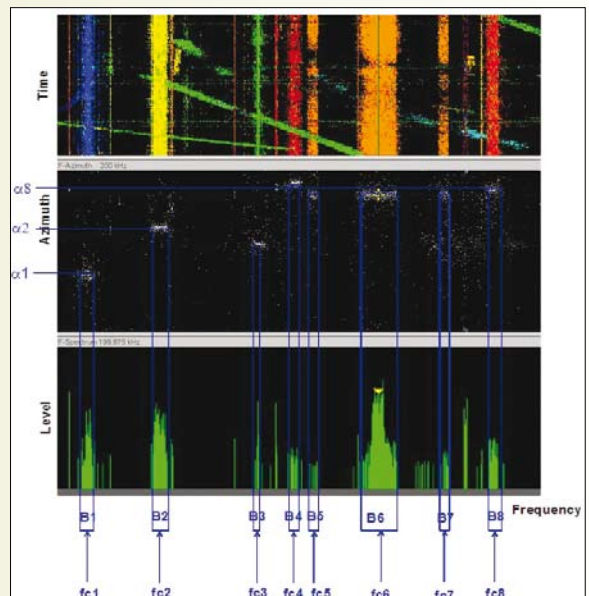

R&S®DDF-CL option: principle of preclassification

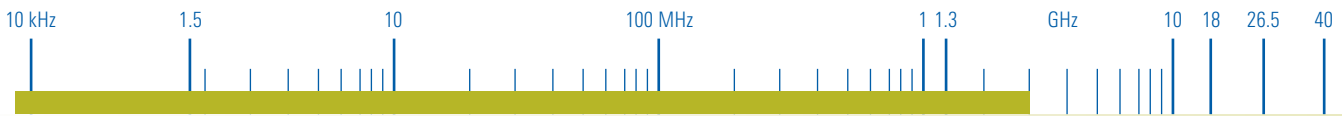

Direction Finders: R&S® DDF0xA/R&S® DDF0xE Digital Direction Finders – Options

This technique not only offers the advantage of being independent of the operator's expertise, but also another important asset, i.e. data reduction.

Radiolocation networks consisting of several direction finders transfer DF results to a central station. The smaller the amount of data to be transferred, the less conspicuous the data transmission. Preclassification maximally reduces data, leaving only the essential information to be transmitted.

High frequency resolution (R&S® DDF-HFR option)

The R&S® DDF05A/E family offers high frequency resolution as standard (HF: 200 Hz, VHF/UHF: 1000 Hz), which is sufficient for most applications. Some applications, however, require extremely high resolution, for example:

- ◆ Direction finding of co-channel interferers: if two transmitters operate in an overlapping spectrum, the bearing error increases and the bearing may even be invalid
- ◆ Direction finding of hidden signals: the same applies as in the case of co-channel interferers. The difference is that the signal searched for deliberately conceals itself in the spectrum of an FM or TV broadcast transmitter, for example

Due to the extremely high frequency resolution achieved with the R&S® DDF-HFR option, the R&S® DDF05A/E family calculates up to a hundred times more bearings per frequency band. As a result, statistical functions such as the histogram and the sliding averaging function yield more accurate results in considerably less time. Moreover, a greater number of interference-free bearings is obtained

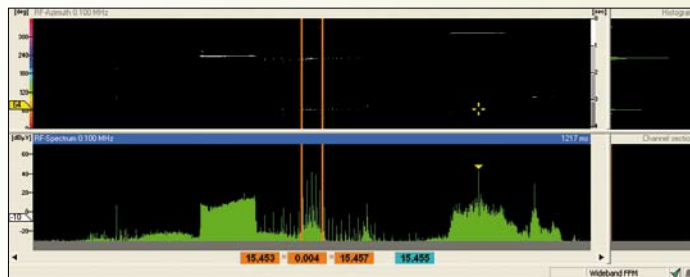

R&S® DDF-HFR option: direction finding of two emitters in the same frequency range with 20 Hz resolution

since, at the instant a bearing is taken, only one transmitter emits a signal at that specific frequency.

The figure at the bottom shows a measurement in the WFFM mode with a resolution of 20 Hz. In the range marked by the two orange lines, a co-channel interferer is superimposed on the signal of interest. Owing to the high resolution, two maxima are clearly discernible in the histogram, and accurate bearings can be taken.

Remote control (R&S® DDFx-REM option)

There are two main reasons for operating the R&S® DDF05A/E family by remote control: improved receive characteristics and simplified control of DF networks.

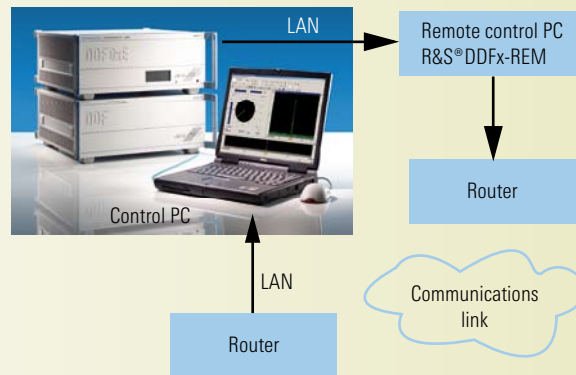

R&S® DDFx-REM option

Improvement of receive characteristics

Man-made noise is particularly high in the shortwave range. Setting up a DF system at a sufficient distance from densely populated areas is therefore mandatory when bearings are to be taken of weak signals. To avoid strong reflections, it is further recommended that HF direction finders be set up as far away as possible from buildings, high-tension lines, streets, and roads. If the DF operators themselves are not stationed at such remote locations, remote control is the solution.

Simplification of DF network operation

If several direction finders are connected to form a network, central control is a great advantage as experienced users are needed only at a single station.

The R&S®DDFE-REM remote control software is installed on a commercial PC close to the DF equipment. Data transmission is organized by commercial routers. Any desired communications link can be used:

- ◆ ISDN
- ◆ GSM/GPRS
- ◆ Satellite link
- ◆ Radio modems
- ◆ Microwave link
- ◆ ... plus many more

The R&S®DDFE-REM software not only provides remote control, but also performs other tasks:

- ◆ Intelligent data reduction to adjust the data volume to be transmitted to the available communications link
- ◆ Audio data compression
- ◆ Multiple station management

Single station locator (R&S®DDF-SSL option)

The shortwave range offers the special opportunity of locating transmitters by means of a single direction finder if their signals are propagated via skywaves. Direction finding makes use of the fact that the shortwave signal is reflected by the ionosphere, and the transmitter location is calculated following the law of angle of incidence being equal to the angle of reflection. The R&S®DDF05A/E family calculates the elevation. The DF quality filter and the histogram function are available for data averaging.

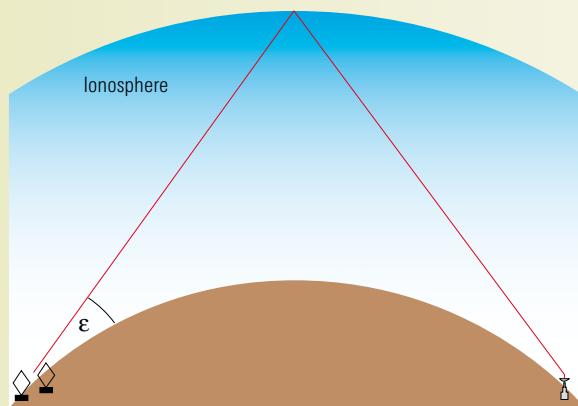

R&S®DDF-SSL option

The height of the ionosphere can be conveniently calculated after entering the current smoothed number of sunspots into the DF system. This information is available in a database, which contains the averaged data of many years and is very accurate. All parameters can of course also be user-defined.

The R&S®DDF-SSL option also offers the possibility of calibrating the height of the ionosphere using a transmitter with a known position.

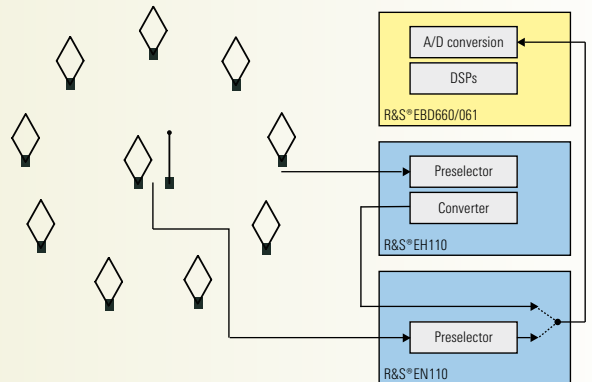

R&S®DDF-LF option

VLF extension (R&S®DDF-LF option)

The R&S®DDF-LF extension expands the R&S®DDF05A/E family, frequency range down to 9 kHz. The frequency range from 1 MHz to 30 MHz may be covered by the R&S®ADD011 DF antenna, for example. Below 1 MHz, a classic Watson-Watt DF antenna consisting of a crossed-loop antenna and a monopole can be used.

Bearings are determined using either the correlative interferometer or the Watson-Watt method, depending on the frequency, thus making maximum use of the two methods: high bearing accuracy and compact antenna dimensions.

Signal processing also differs for the two ranges. Above 1 MHz, three classic analog receivers with a preselector and a converter are employed. Below this frequency, the receive signals are merely passed through a broadband filter and then applied directly to the A/D converters. Subsequent filtering is performed digitally by means of software receivers.

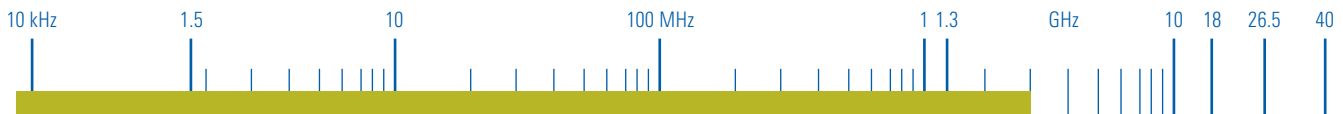

Synchronous scanning (R&S® DDF-TS option)

To locate a transmitter by triangulation, bearings are required of several direction finders. This is ensured for signals with normal transmission duration of a few hundred milliseconds and above.

With frequency-agile LPI signals such as hoppers and bursts, the duration of a single transmission is very short. Moreover, the frequency is not known, so that large frequency ranges have to be scanned. It may happen that only one direction finder is operating at the correct frequency at the moment of an emission. Locating the transmitter searched for is then impossible.

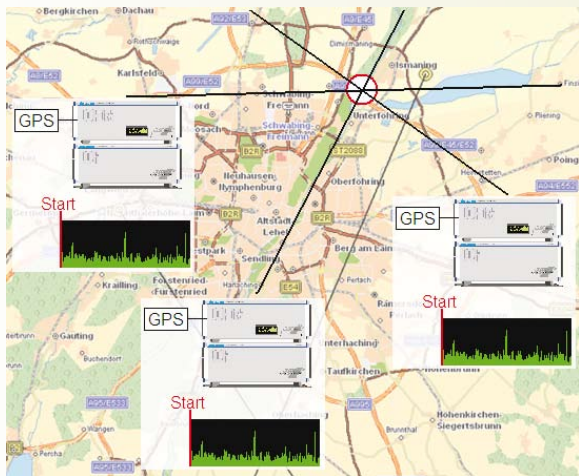

R&S® DDF-TS option

Using the R&S® DDF-TS option, the scan activities are synchronized, i.e. each direction finder measures exactly at the same frequency at the same time. A reliable bearing of any detected signal is taken by each direction finder, and the signal is located with maximum accuracy. Synchronization is highly accurate due to the use of GPS.

The R&S® DDF-TS option is therefore an important prerequisite for DF networks locating LPI signals.

Service kit for maintenance and troubleshooting (R&S® DDF-SK option)

The R&S® DDF-SK option considerably cuts the time required for maintenance and troubleshooting of the R&S® DDF0xA/E family.

All tools essential for checking the DF system are conveniently accommodated in a rugged case. An important tool is the R&S® ZT660 antenna simulation, which is connected to the direction finder instead of the DF antenna to perform system tests. It can be set to simulate any desired Rohde & Schwarz DF antenna. Using the antenna simulation, it can conveniently be checked whether a fault originates from the DF antenna or the DF equipment. This relieves the operator from having to climb the antenna mast or even dismount the DF antenna unnecessarily. The antenna simulation also allows a signal generator to be connected to the DF system, and to take test bearings of its signals with a predefined direction.

The service kit contains the following test equipment:

- ◆ R&S® ZT660 antenna simulation
- ◆ Various cables and adapters
- ◆ Various tools for opening housings and enclosures

The following tests can be performed, for example:

- ◆ Localization of faults as originating from the DF equipment or DF antenna
- ◆ Testing of the three receive paths
- ◆ Taking a test bearing of signals with known direction

Direction Finders: R&S®DDF0xA/R&S®DDF0xE Digital Direction Finders – Options

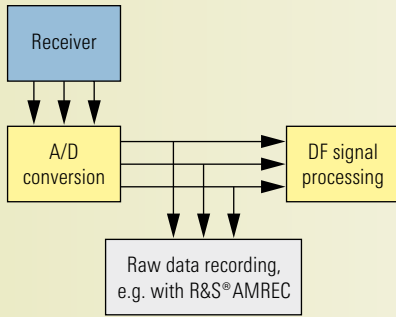

R&S®DDF-DR option

Output of digitized raw data (R&S®DDF-DR option)

If the R&S®DDF0xA/E family is used as a data source for an analysis system such as the R&S®AMMOS, digitized, unprocessed intermediate-frequency (IF) data has to be output.

The R&S®DDF-DR option allows raw data to be output via a standardized FPDP interface. The digitized IF data of the three receive paths are brought out at this interface and can be recorded by means of the R&S®AMREC, for example.

Option for the R&S®DDF0xA only

Broadband direction finding and HF extension (R&S®DDFA-WB option)

The R&S®DDFA-WB option significantly boosts the already high scan speed in the HF range. It expands the realtime bandwidth from 1 MHz to up to 10 MHz, thus providing a considerably higher probability of intercept for short-term and frequency-agile signals. The complete HF band is searched, at good resolution, in less than 100 ms.

When switchover is made to broadband direction finding, the preselectors are bypassed and the antenna signals are applied directly to the A/D converters. Further signal processing is digital.

The R&S®DDFA-WB option performs several tasks, depending on the base unit in which it is installed. In the case of the R&S®DDF01A, the realtime bandwidth is increased to 10 MHz; in the case of the R&S®DDF05A, the frequency range is extended to also include the HF band.

R&S®DDFA-WB option to include the HF band for the R&S®DDF05A VHF/UHF direction finder

A compact HF DF antenna, for example the R&S®ADD119, is connected to the R&S®ET550 DF converter. When VHF/UHF is selected, the antenna signals are routed through the preselectors and converters. When HF is selected, the antenna signals are directly applied to the A/D converters of the DF processor. After A/D conversion, the signals are further processed by means of software receivers. Bearings are calculated with 10 MHz realtime bandwidth employing the correlative interferometer or the Watson-Watt method, depending on the DF antenna used.

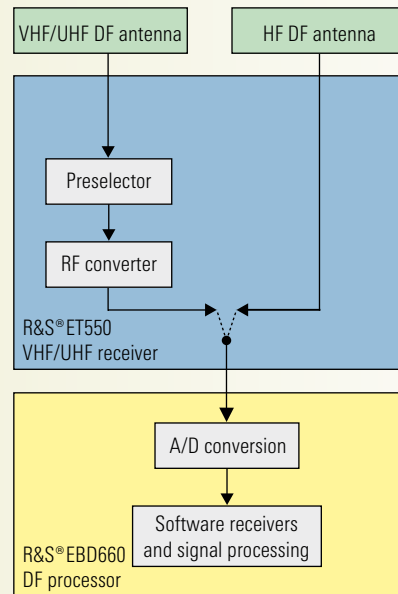

R&S®DDFA-WB option to expand the realtime bandwidth for the R&S®DDF01A HF direction finder

The spectrum can first be scanned at maximum speed with 10 MHz FFT realtime bandwidth. In this mode, the antenna signals are directly applied to the A/D converters; further signal processing is digital.

On detecting a transmitter of interest, switchover is made to the normal mode, and the antenna signals are routed through the preselectors and converters. This procedure yields better results especially for weak signals and for locations in the vicinity of strong transmitters.

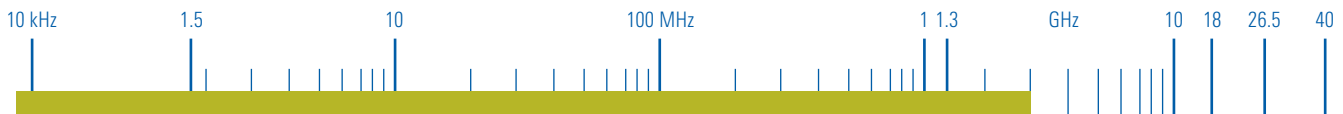

Direction Finders: R&S®DDF0xA/R&S®DDF0xE Digital Direction Finders – Options

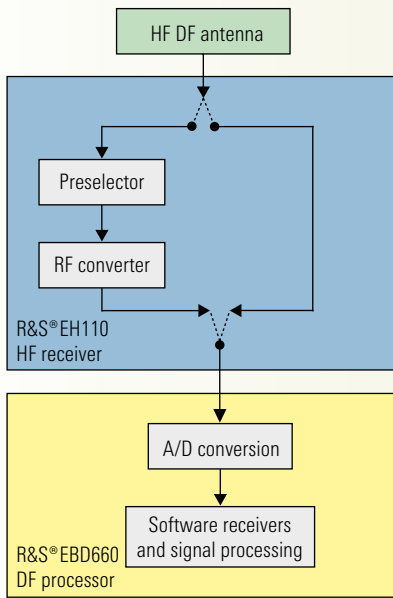

The fact that the HF signals are directly applied to the A/D converters without a narrowband preselector such as R&S®EM110 slightly increases the direction finder's sensitivity to strong transmitters. However, since the R&S®DDFE-HF option is normally used with compact and therefore less sensitive DF antennas, this disadvantage can be considered insignificant.

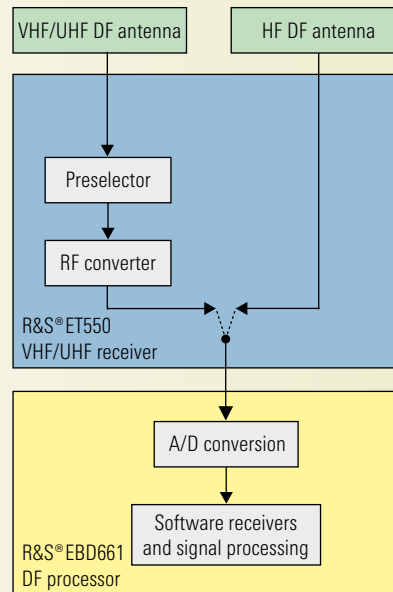

Option for the R&S®DDF0xE only

HF extension for the VHF/UHF direction finder (R&S®DDFE-HF option)

The R&S®DDFE-HF option turns the R&S®DDF05E VHF/UHF direction finder into an extremely compact full-range direction finder covering the frequency range from 300 kHz to 3 GHz. Since the R&S®DDFE-HF is a pure software option, it does not increase the size of the direction finder. A compact HF DF antenna, for example the R&S®ADD119, is connected to the R&S®ET550 DF converter. When VHF/UHF is selected, the antenna signals are routed through the preselectors and converters. When HF is selected, the antenna signals are directly applied to the A/D converters of the DF processor. After A/D conversion, preselection and conversion of the HF signals are performed by software receivers. Bearings are calculated employing the correlative interferometer or the Watson-Watt method, depending on the DF antenna used.

3

Chapter Overview

Type Index

Main Menu

Direction Finders

3

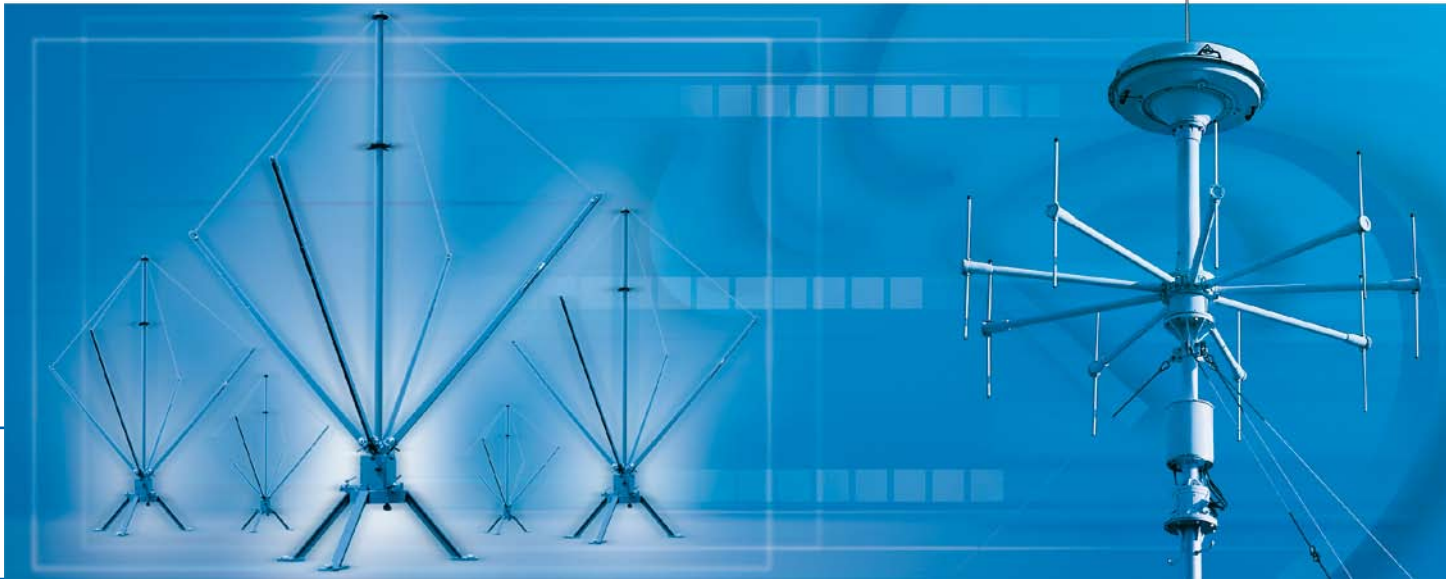

R&S® ADDx DF Antennas

20 MHz to 3000 MHz

Main features

- ◆ Antennas for direction finding in line with the correlative interferometer principle or the Watson-Watt method
- ◆ Antennas for stationary and mobile use
- ◆ High DF accuracy and sensitivity
- ◆ Coverage of wide frequency ranges without splitting into subranges
- ◆ Direction-independent DF characteristics due to exclusive use of circular antenna arrays

Brief description

A variety of DF antennas is available for the R&S® DDF0xA and R&S® DDF0xE direction finders to match different applications. They cover the frequency ranges from 0.3 MHz to 3 GHz. The antennas offered include crossed-loop and circular arrays. All the antennas offered feature a coding function to inform the DF system of the algorithm (Watson-Watt or correlation) to which the direction finder is to be set. Optionally, the antennas for mobile use can be equipped with an electronic compass in order to automatically reference the bearings to magnetic north. Adapters are available for installing the mobile DF antennas on vehicles or masts, e.g. on ships. The cable inputs and outputs of the DF antennas are overvoltage-protected as standard. For the R&S® ADD153, R&S® ADD050 and R&S® ADD053 VHF/UHF DF antennas, a lightning rod is supplied to protect the equipment against direct strokes.

Chapter
Overview

Type
Index

Main
Menu

Direction Finders: R&S®ADDx DF Antennas

In many cases, non-Rohde & Schwarz antennas (Adcock) already installed can be used with the direction finders. For this, the R&S®GX060 antenna interface (0.3 MHz to 650 MHz) is required.

The add-on R&S®GH150 electronic compass can be fixed to the R&S®ADD119, R&S®ADD153, R&S®ADD155 and R&S®ADD170 antennas for automatic direction finding referenced to north.

The R&S®VE010 multicoupler makes it possible to operate up to six R&S®DDF01A or R&S®DDF01E direction finders from one R&S®ADD010 or R&S®ADD011 HF DF antenna. With the R&S®VE010, the R&S®DDF0xA/E direction finders can be connected to the HF DF antenna in any combination and operated completely independently of one another.

The R&S®ADD1xZ antenna cable is required for connecting the HF DF antenna to the DF equipment. The cable is available in various lengths to suit the application.

For the VHF/UHF range, the R&S®ADD5xZ or R&S®ADD7xZ antenna cable is used. For cable lengths exceeding 10 m for the VHF/UHF range, the R&S®IN061 power supply is supplied with the cable.



R&S®ADD011



VHF/UHF DF antenna system (R&S®ADD153 (top), R&S®ADD050 (center), R&S®ADD070 (bottom))

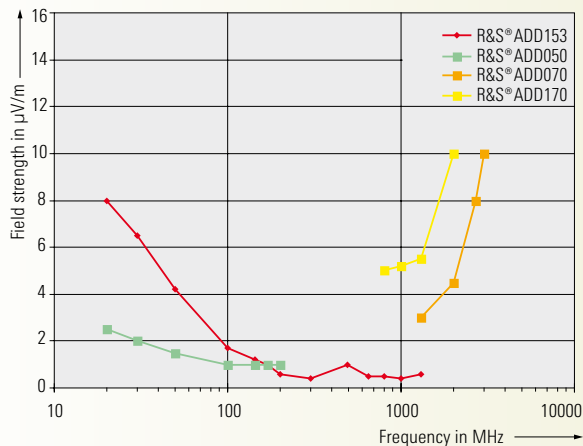

Sensitivity of DF antennas; averaging time 1 s, bearing fluctuation $\leq 2^\circ$ RMS, bandwidth 1 kHz

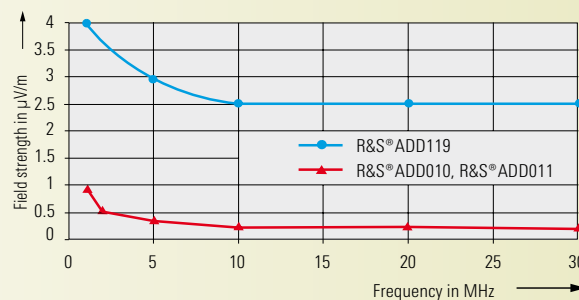

Specifications – HF antennas

R&S®ADD119

Application	mobile, fast scanning for ground waves and sky waves with low elevation angle
Frequency range	(0.3 MHz) 1 MHz to 30 MHz, below 1 MHz with limited sensitivity and accuracy
Antenna type	1 crossed loop and 1 active dipole
DF method	Watson-Watt
Polarization	vertical
DF accuracy ¹⁾	2° RMS
Sensitivity	typ. 4 µV/m to 2.5 µV/m (2° bearing fluctuation, 1 kHz bandwidth, 1 s averaging time)
Power supply	from DF equipment
Dimensions (approx.)	1100 mm (43.31 in) diameter × 232 mm (9.13 in) height
Color	RAL 1015
Weight (approx.)	25 kg (55.12 lb)



R&S®ADD010

(The figure shows an antenna element of the R&S®ADD010, which in total contains nine elements arranged on a circle 50 m in diameter.)

Application	semimobile and stationary, for signals with elevation angle ≤50°, SSL possible to a limited extent
Frequency range	(0.3 MHz) 1 MHz to 30 MHz, below 1 MHz with limited sensitivity and accuracy
Antenna type	active 9-element circular array of rod antennas
DF method	correlation
Polarization	vertical
DF accuracy ¹⁾	1° RMS
Sensitivity	typ. 1 µV/m to 0.2 µV/m (2° bearing fluctuation, 1 kHz bandwidth, 1 s averaging time)
Power supply	from power supply built in as standard
Dimensions (approx.)	antenna circle: 50 m (1968.50 in) diameter, height of rod antenna: 2 m (78.74 in)
Color	RAL 6014
Weight (approx.)	single element with base plate: 14 kg (30.86 lb), network: 22 kg (48.50 lb)

¹⁾ Measurement in reflection-free environment. The RMS error is calculated from the bearings of an evenly distributed azimuth and frequency sample.

R&S®ADD011

Application	stationary, for signals with elevation angle ≤85°, SSL possible
Frequency range	(0.3 MHz) 1 MHz to 30 MHz, below 1 MHz with limited sensitivity and accuracy
Antenna type	active 9-element circular array of crossed loop antennas
DF method	correlation
Polarization	vertical, horizontal, circular
DF accuracy ¹⁾	1° RMS
Sensitivity	typ. 1 µV/m to 0.2 µV/m (2° bearing fluctuation, 1 kHz bandwidth, 1 s averaging time)
Power supply	from power supply built in as standard
Dimensions (approx.)	antenna circle: 50 m (1968.50 in) diameter, height of crossed loop: 3.5 m (137.80 in) incl. tripod
Color	RAL 6014
Weight (approx.)	single element with base plate: 32 kg (70.55 lb), network: 22 kg (48.50 lb)

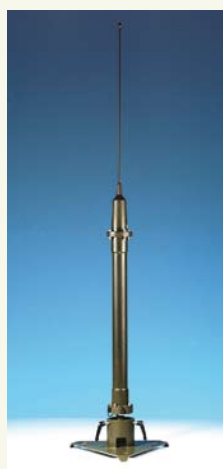

Specifications – VHF/UHF antennas

R&S®ADD153

Application	VHF/UHF, mobile and stationary
Frequency range	20 MHz to 1300 MHz
Antenna type	9 active antenna elements in radome
DF method	correlation
Polarization	vertical
DF accuracy ¹⁾	2° RMS (20 MHz to 200 MHz) 1° RMS (200 MHz to 1300 MHz)
Sensitivity	typ. 8 µV/m to 0.5 µV/m (2° bearing fluctuation, 1 kHz bandwidth, 1 s averaging time)
Wind load/center of wind load	
Without ice deposit	at 188 km/h: 710 N/210 mm
With 30 mm ice deposit	at 162 km/h: 770 N/270 mm
Power supply	from DF equipment
Dimensions (approx.)	1100 mm (43.31 in) diameter × 297 mm (11.69 in) height (height incl. lightning rod: 1327 mm (52.24 in))
Color	RAL 1015
Weight (approx.)	30 kg (66.14 lb)



R&S®ADD050

Application	VHF, stationary, enhanced accuracy especially with multipath propagation
Frequency range	20 MHz to 200 MHz
Antenna type	active 9-element circular array
DF method	correlation
Polarization	vertical
DF accuracy ¹⁾	1° RMS
Sensitivity	typ. 2.5 µV/m to 1 µV/m (2° bearing fluctuation, 1 kHz bandwidth, 1 s averaging time)
Wind load/center of wind load	
Without ice deposit	at 188 km/h: 1700 N/380 mm
With 30 mm ice deposit	at 162 km/h: 2800 N/410 mm
Power supply	from DF equipment, R&S®IN061 power supply may be required for cables with a length >20 m (details upon request)
Dimensions (approx.)	antenna circle: 3 m (118.11 in) diameter, height: 800 mm (31.50 in), with lightning rod: 3 m (118.11 in)
Color	RAL 1015
Weight (approx.)	70 kg (154.32 lb)

R&S®ADD053

Application	VHF/UHF, stationary, combination of R&S®ADD153 and R&S®ADD050
Frequency range	20 MHz to 1300 MHz
Antenna type	2 × active 9-element circular array
DF method	correlation
Polarization	vertical
DF accuracy ¹⁾	1° RMS
Sensitivity	typ. 0.5 µV/m to 1 µV/m (2° bearing fluctuation, 1 kHz bandwidth, 1 s averaging time)
Wind load/center of wind load	
Without ice deposit	at 188 km/h: 2700 N/800 mm
With 30 mm ice deposit	at 162 km/h: 3700 N/690 mm
Power supply	from DF equipment, R&S®IN061 power supply may be required for cables with a length >20 m (details upon request)
Dimensions (approx.)	antenna circle: 3 m (118.11 in) diameter, height: 800 mm (31.50 in), with lightning rod: 3 m (118.11 in)
Color	RAL 1015
Weight (approx.)	114 kg (251.33 lb)



¹⁾ Measurement in reflection-free environment. The RMS error is calculated from the bearings of an evenly distributed azimuth and frequency sample.

Direction Finders: R&S® ADDx DF Antennas

R&S® ADD070²⁾

Application	UHF, stationary, can be mounted below VHF/UHF antennas on same mast
Frequency range	1300 MHz to 3000 MHz
Antenna type	8-element circular array
DF method	correlation
Polarization	vertical
DF accuracy ³⁾	2° RMS
Sensitivity	typ. 3 µV/m to 10 µV/m (2° bearing fluctuation, 1 kHz bandwidth, 1 s averaging time)
Wind load/center of wind load	
Without ice deposit	at 180 km/h: 200 N/250 mm (model .12) at 200 km/h: 530 N/620 mm (model .02)
With 30 mm ice deposit	at 140 km/h: 210 N/260 mm (model .12) at 176 km/h: 530 N/680 mm (model .02)
Power supply	from DF equipment
Dimensions (approx.)	340 mm (13.39 in) diameter × 1200 mm (47.24 in) height (model .02) 340 mm (13.39 in) diameter × 492 mm (19.37 in) height (model .12)
Color	RAL 1015
Weight (approx.)	
Model .02	90 kg (198.42 lb)
Model .12	11 kg (24.25 lb)



R&S® ADD070M

Application	UHF, mobile
Frequency range	1300 MHz to 3000 MHz
Antenna type	8-element circular array
DF method	correlation
Polarization	vertical
DF accuracy ³⁾	2° RMS
Sensitivity	typ. 3 µV/m to 10 µV/m (2° bearing fluctuation, 1 kHz bandwidth, 1 s averaging time)
Wind load/center of wind load	
Without ice deposit	at 180 km/h: 199 N/170 mm With 30 mm ice deposit at 140 km/h: 160 N/180 mm
Power supply	from DF equipment
Dimensions (approx.)	455 mm (17.91 in) diameter × 364 mm (14.33 in) height
Color	RAL 1015
Weight (approx.)	11 kg (24.25 lb)

²⁾ Model .12: lightweight model for mobile use.

³⁾ Measurement in reflection-free environment. The RMS error is calculated from the bearings of an evenly distributed azimuth and frequency sample.

R&S® ADD170

Application	optimized for mobile direction finding in GSM bands
Frequency range	800 MHz to 2000 MHz
Antenna type	8-element circular array with center antenna
DF method	correlation
Polarization	vertical
DF accuracy ³⁾	2° RMS
Sensitivity	typ. 5 µV/m to 10 µV/m (2° bearing fluctuation, 1 kHz bandwidth, 1 s averaging time)
Wind load/center of wind load	
Without ice deposit	at 180 km/h: 350 N/180 mm
With 30 mm ice deposit	at 140 km/h: 280 N/200 mm
Power supply	from DF equipment
Dimensions (approx.)	455 mm (17.91 in) diameter × 393 mm (15.47 in) height
Color	RAL 1015
Weight (approx.)	11 kg (24.25 lb)

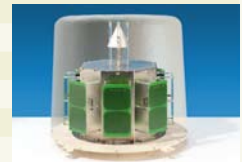

R&S® ADD216

Application	HF/VHF/UHF compact DF antenna
Frequency range	300 kHz to 3000 MHz
Antenna type	ferrite loops and 8-element circular arrays with center antenna
DF method	Watson-Watt (HF) and correlation (VHF/UHF)
Polarization	vertical
DF accuracy	2° RMS
Sensitivity	typ. 15 µV/m to 1 µV/m (3 MHz to 3000 MHz)
Wind load/center of windload	
Without ice deposit	at 275 km/h: 960 N/440 mm
With 30 mm ice deposit	at 210 km/h: 710 N/440 mm
Power supply	from DF equipment
Dimension (approx.)	550 mm (21.65 in) diameter × 850 mm (33.46 in) height
Color	RAL 7000
Weight (approx.)	48 kg (105.82 lb)

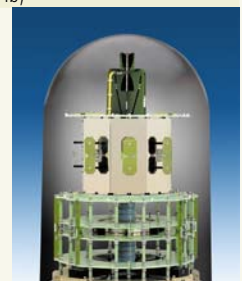

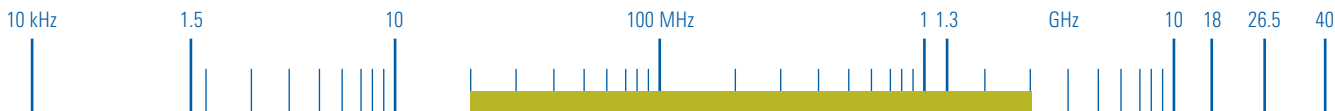

Direction Finders: R&S®ADDx DF Antennas

Specifications

R&S®IN061

Power supply 115/230 V AC ±15 %, 47 Hz to 63 Hz;
20 V to 32 V DC, max. 4.5 A

Operating

temperature range -40 °C to +65 °C

Dimensions (W × H × D) 345 mm × 255 mm × 155 mm

(13.58 in × 10.04 in × 6.10 in)

Weight 10 kg (22.05 lb)

Ordering information

HF Antennas

(0.3) 1 MHz to 30 MHz R&S®ADD119 4053.6509.02

(0.3) 1 MHz to 30 MHz R&S®ADD010 4045.0105.03

(0.3) 1 MHz to 30 MHz R&S®ADD011 4045.0005.13

VHF/UHF Antennas

20 MHz to 1300 MHz R&S®ADD153 4063.0003.02

20 MHz to 200 MHz R&S®ADD050 4041.4006.02

20 MHz to 1300 MHz R&S®ADD053 4062.8800.02

1300 MHz to 3000 MHz R&S®ADD070 4043.4003.02

1300 MHz to 3000 MHz R&S®ADD070 4043.4003.12¹⁾

800 MHz to 2000 MHz R&S®ADD170 4055.7502.02

300 kHz to 3000 MHz R&S®ADD216 4068.3000.02

¹⁾ Model .12: lightweight model for mobile use.

Accessories

Antenna cable R&S®ADDxxZ on request

Electronic Compass R&S®GH150 4041.8501.02

Recommended extras

Antenna Interface R&S®GX060 4050.8500.02

Multicoupler R&S®VE010 4050.8000.02

3

Chapter
Overview

Type
Index

Main
Menu

Direction Finders



3

R&S® DDF195 Digital Direction Finder

0.5 MHz to 3 GHz

Main features

- ◆ Outstanding accuracy and sensitivity
- ◆ Superior receiver performance
- ◆ Very short signals of 10 ms detectable
- ◆ Algorithms for correlative interferometer and Watson-Watt as standard

Brief description

The R&S® DDF195 digital direction finder may consist of the following elements:

- ◆ R&S® ADD119 HF DF antenna (0.5 MHz to 30 MHz)
- ◆ R&S® ADD195 VHF/UHF DF antenna (20 MHz to 1300 MHz)
- ◆ R&S® ADD071 UHF DF antenna (1.3 GHz to 3 GHz)
- ◆ R&S® EBD195 DF unit
- ◆ R&S® DDF190Z cable set

Moreover, a monitoring receiver with unregulated IF output of 10.7 MHz or 21.4 MHz (e.g. R&S® EB200, R&S® ESMB or R&S® ESMC) is required.

The R&S® DDF195 digital direction finder can be operated in line with two DF methods using digital signal processing: the tried and tested Watson-Watt method (HF band) and the advanced correlative interferometer method (VHF/ UHF band). The system allows direction finding of signals with any modulation.

Chapter
Overview

Type
Index

Main
Menu

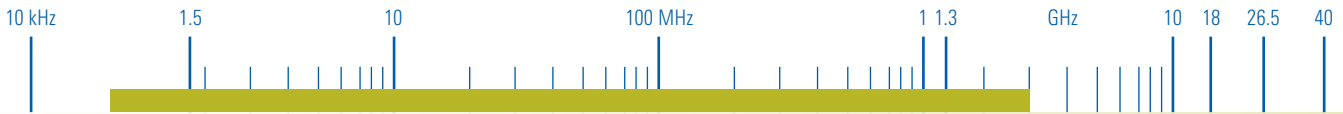

Three operating modes can be selected on the DF processor:

- ◆ **NORMAL:** In this mode, which is preferably used for monitoring radio networks, the DF process is started and stopped by the squelch of the DF processor. The bearing display follows the various directions of incidence of the signals without any delay
- ◆ **GATE:** This mode is used for direction finding of transmitters whose emissions are interrupted briefly by modulation (e.g. keyed transmitters) if the transmitter on-the-air time is too short for NORMAL operating mode
- ◆ **CONT:** In this mode, direction finding is performed continuously so that a bearing may be obtained even for specially modulated or very weak signals for which the DF process is not triggered by the squelch

In each of these modes, bearings can also be displayed in a histogram, which is of advantage in the analysis of communications networks. Histograms display the current bearing in digital form (three-digit number), and all values obtained since the activation of this display mode are shown as radial beams indicating the direction of incidence. The lengths of the beams are a measure of frequency occurrence of the bearings.

The display mode can also be switched to QDM (heading with reference to magnetic north). Results can be output as lists.



R&S® ADD119 antenna in mobile use

HF extension

To cover the HF range, the R&S® ADD119 HF DF antenna has to be connected to the receiver.

Connection of and to DF unit

If the R&S® DDF195 is operated only in the HF range, the connections between the R&S® ADD119 DF antenna and the DF processor are straightforward. Where the R&S® ADD195 DF antenna and/or R&S® ADD071 DF antenna are to be used in addition, the R&S® GX190 junction unit is needed. The junction unit performs frequency-dependent, automatic switchover to the DF antenna required and allows up to three communications receiving antennas to be connected to the receiver input.

Where it is not possible to mount all DF antennas at the top of the mast, the R&S® ADD119 DF antenna must be fitted on a bracket on the side of the mast. This asymmetrical installation leads to bearing errors, which can however be kept low by fitting a second R&S® ADD119 on the opposite side of the mast. The signals from the two antennas are taken to the R&S® GX119 combiner and then to the DF equipment.

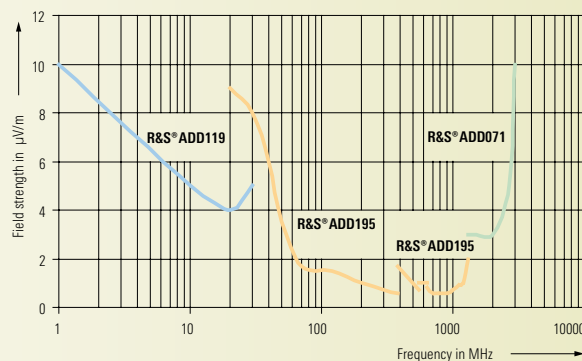

Typical sensitivity of the R&S® DDF195 with Rohde & Schwarz receiver: <math>< 5 \times \text{RMS bearing fluctuation}</math>, 1 kHz bandwidth (250 Hz for R&S® ADD119), 5 s averaging time

DF antennas

For the R&S®DDF195, three DF antennas are available for mobile and stationary applications covering the frequency ranges 0.5 MHz to 30 MHz (R&S®ADD119), 20 MHz to 1300 MHz (R&S®ADD195) and 1.3 GHz to 3 GHz (R&S®ADD071).



R&S®ADD195 (top) and R&S®ADD071

Use in computer-controlled systems

For use in computer-controlled systems, Rohde & Schwarz offers the R&S®ARGUS system monitoring software and R&S®RAMON.

R&S®RAMON, used in the military field, is for fast frequency detection and transfer to support monitoring receivers, while R&S®ARGUS is intended for civil applications, e.g. for authorities with frequency management tasks such as long-term monitoring of specific frequency bands.

Rohde & Schwarz also offers a solution for triangulation systems. Two or more direction finders can be combined with the R&S®MONLOC software to form a radiolocation network. The position of the direction finders, the bearing lines and the location of the signal source are displayed on a digital map.

Antenna accessories

If the R&S®DDF195 is operated only with the R&S®ADD119 in the shortwave range, or with the R&S®ADD195/ R&S®ADD071 in the VHF/UHF range, the connections between the R&S®ADD119 DF antenna and the DF processor are straightforward (R&S®DDF190Z cable set consisting of one RF cable, one control cable and, if necessary, the R&S®IN061 power supply). Where the R&S®ADD119 and R&S®ADD195 and/or R&S®ADD071 DF antennas are to be used simultaneously, the R&S®GX190 connection board is needed, since the R&S®EBD195 has only one control output and each receiver only one RF input. The connection board performs frequency-dependent, automatic switchover to the DF antenna required and allows up to three communications receiving antennas to be connected to the receiver input. Switchover is made via the DF/AF keys on the R&S®EBD195.

Where it is not possible to mount all DF antennas at the top of the mast, the R&S®ADD119 DF antenna must be fitted on a bracket on the side of the mast. This asymmetrical installation leads to bearing errors, which can however be kept low by fitting a second R&S®ADD119 on the opposite side of the mast. The signals from the two antennas are taken to the R&S®GX119 combiner and then to the DF equipment.

An R&S®GH150 electronic compass can be connected to each antenna, if desired, so that direction finding with reference to north is possible at any time irrespective of the mechanical alignment of the antennas.

Various adapters are available for the DF antennas allowing stationary installation on a mast or mobile installation on a vehicle/shelter, for example.

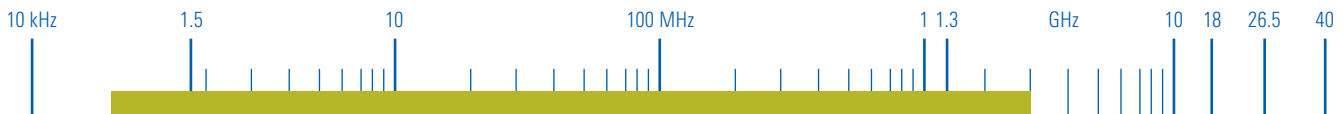

Direction Finders: R&S®DDF195 Digital Direction Finder

Specifications

DF method	Watson-Watt or correlative interferometer	Averaging time	100 ms to 5 s
Frequency range (depending on receiver/DF antenna)		Squelch for level and quality	internally or externally selectable
HF	0.5 MHz to 30 MHz	IF input	10.7 MHz or 21.4 MHz, 50 Ω, level <0 dBm unregulated (i.e. without AGC), broadband or narrowband
VHF/UHF	20 MHz to 1300 MHz	DF display	graphic LCD on front panel; three-digit display with additional indication of direction on compass rose
UHF	1.3 GHz to 3 GHz	Data interface	RS-232-C for remote control of system, 2nd serial interface and parallel interface for receiver control
DF accuracy in reflection-free environment		General data of the R&S® EBD195	
0.5 MHz to 30 MHz	2° RMS	Operating temperature range	-10 °C to +55 °C
30 MHz to 80 MHz	2° RMS	Power supply	
80 MHz to 1300 MHz	1° RMS	AC	100/120/230/240 V, -12%/+10 %, 47 Hz to 440 Hz, overvoltage-protected in line with VDE 160, ≤40 VA
1.3 GHz to 3 GHz	2° RMS	DC	10 V to 32 V, ≤20 W
Resolution of A/D converter	16 bit	Dimensions (W × H × D)	219 mm × 147 mm × 460 mm (8.62 in × 5.79 in × 18.11 in)
Minimum signal duration	10 ms	Weight	approx. 10 kg (22.05 lb)
DF sensitivity (≤5° RMS fluctuation, 5 s averaging time, 1 kHz bandwidth, Rohde & Schwarz receiver)			
HF	typ. 10 μV/m to 4 μV/m (frequency-dependent)		
VHF/UHF	typ. 1 μV/m to 9 μV/m (frequency-dependent)		
UHF	typ. 3 μV/m to 10 μV/m		
Bandwidths	1 kHz, 2.5 kHz, 8 kHz, 25 kHz, 100 kHz		

3

Chapter Overview

Type Index

Main Menu

Ordering information

Digital Direction Finder	R&S®DDF195		Recommended extras		
0.5 MHz to 30 MHz		4061.8007.02	HF DF Antenna	R&S®ADD119	4053.6509.02
20 MHz to 1300 MHz		4061.8007.03	Junction Unit	R&S®GX190	4032.1508.02
20 MHz to 3000 MHz		4061.8007.04	Combiner	R&S®GX119	4032.1008.02
			Remote-control software		on request
			Antenna cables		on request

Direction Finders

R&S® DDF100M Digital Direction Finder for Traffic Control

118 MHz to 250 MHz

Main features

- ◆ Outstanding accuracy and sensitivity
- ◆ Superior receiver performance
- ◆ Quasi-simultaneous operation on up to four frequency channels
- ◆ Adaptive interference cancellation (option)



Brief description

In coastal areas, land-based stations and vessels communicate on defined radio channels in the VHF range. For vessel traffic management, Rohde & Schwarz developed the R&S® DDF100M digital VHF/UHF direction finder, which consists of the following equipment:

- ◆ R&S® ADD090 or R&S® ADD090M VHF DF antenna (118 MHz to 250 MHz)
- ◆ R&S® EBD100M DF processor
- ◆ R&S® ESMB monitoring receiver as DF receiver
- ◆ R&S® DDF190Z cable set (on request)

3

Chapter
Overview

Type
Index

Main
Menu

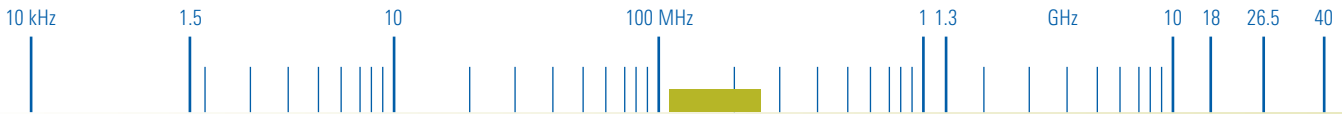

Direction Finders: R&S®DDF100M Digital Direction Finder for Traffic Control

Characteristics and operation

The R&S®DDF100M digital direction finder operates in accordance with the advanced correlative interferometer method. The bearing is taken using digital signal processing methods by comparing the complex antenna voltages of the signals received with reference values, and checking them for maximum correlation. This DF method enables the implementation of wide-aperture DF antennas that comprise only a few antenna elements and cover wide frequency ranges without division into subranges.

The R&S®EBD100M DF processor does not feature any front-panel operating and display elements. It is operated via an RS-232-C interface either directly from the control PC or by means of remote control.

The system allows direction finding of signals with any modulation. Three operating modes can be selected:

- ◆ **DF1:** direction finding of a single frequency with moving average and 100 ms minimum signal duration (only versions without interference canceller, order no. x.12 or x.14)
- ◆ **DF2:** quasi-simultaneous direction finding on up to four frequency channels. The bearings of all frequencies are output with an update rate of 1/s. For a reliable interception of signals on all frequencies, the DF system dwells on each frequency for 300 ms
- ◆ **DF3:** same as DF1 but higher sensitivity due to longer measurement time (minimum signal duration 600 ms)

Interfaces

The R&S®DDF100M digital direction finder can be operated or remote-controlled via a serial RS-232-C interface. The R&S®DDF1M-CTL software (option) is to be installed on the computer in the operational center. It allows the presentation of the DF results for the two frequency channels that are used in the switchover process. This software also comes with each direction finder so that service personnel can operate the direction finder on site during installation and maintenance. The free-of-charge operation is limited to 15 minutes.

To operate R&S®DDF1M-CTL, the R&S®RA-BASIC RAMON basic module has to be installed.

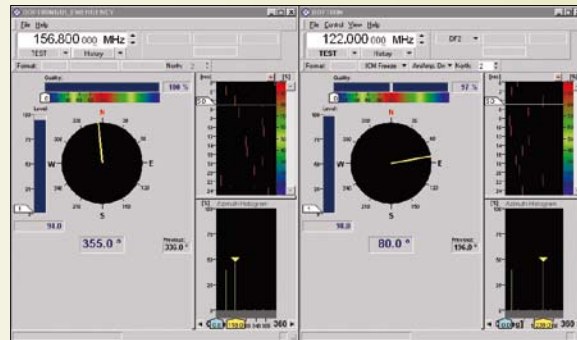

Graphical user interface (GUI) for the R&S®DDF100M

DF antennas

For the R&S®DDF100M, the two R&S®ADD090 DF antennas (diameter 2 m, installation on top of a mast) and R&S®ADD090M (installation around a mast) are available for stationary applications covering the frequency range 118 MHz to 250 MHz. The antenna cables can be delivered in various lengths on request.



R&S®ADD090 VHF DF antenna



R&S®ADD090M VHF DF antenna

Adaptive interference canceller module (ICM)

In some cases, both the DF antenna and maritime radio-communications antennas are mounted on a mast. Since the ships to be detected transmit in the same frequency range in which maritime radiocommunications take place, direction finding may be impaired. As a remedy, the R&S®DDF100M can be expanded by an optional adaptive interference canceller module (ICM).

The figure shows that – in addition to the signal to be detected – also an interfering signal originating from the communications transmitters is received by the DF antenna. A small part of the transmit signal is coupled out at the transmitter output and applied to the ICM. As required, the R&S®HP090 sensor antenna can be mounted near the transmit antenna. In the ICM, a complex circuit adds the coupled-out transmit signal at the same amplitude but with 180° phase rotation to the DF antenna signal. The interfering signal is thus largely cancelled. This process is permanently controlled and optimized via a feedback. The ICM can cancel up to six interfering signals in the frequency range from 150 MHz to 174 MHz.

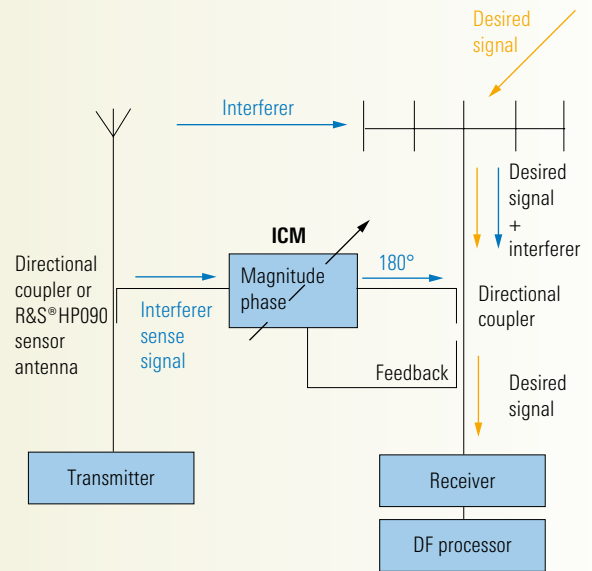

In contrast to conventional passive filters, this adaptive interference canceller module ensures the effective suppression of adjacent-channel interferers without filtering parts of the maritime frequency range.

Specifications

Frequency range	118 MHz to 250 MHz	Data interface	(R&S®EBD100M) RS-232-C for remote control of the system, second serial interface for receiver control
DF method	correlative interferometer	General data	
DF accuracy in reflection-free environment ¹⁾	<1° RMS (R&S®ADD090) <1.5° RMS (R&S®ADD090M)	Operating temperature range	R&S®EBD100M/R&S®GX090C/ R&S®ESMB -10 °C to +55 °C R&S®ADD090(M)/ R&S®GX090(M) -40 °C to +65 °C
Operating modes		Storage temperature range	R&S®EBD100M/R&S®GX090C/ R&S®ESMB -40 °C to +70 °C R&S®ADD090(M)/ R&S®GX090(M) -40 °C to +85 °C
DF1, DF3	single frequency channel		
DF2	quasi-simultaneous direction finding on up to four channels		
Minimum signal duration	100 ms (version without interference canceller in DF1 mode) 600 ms (version with interference canceller in DF3 mode)		
DF sensitivity (≤2° RMS fluctuation, 1 s signal duration, 15 kHz bandwidth)	5 μV/m, cable loss <3 dB		

¹⁾ Sample divided up equally across azimuth.

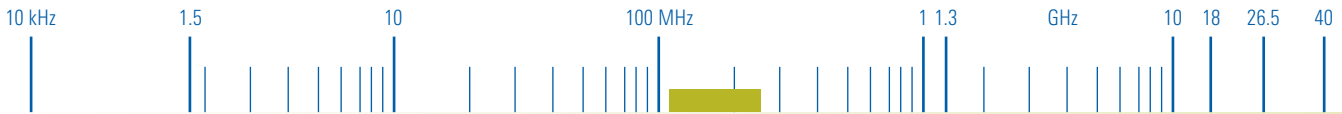

Direction Finders: R&S®DDF100M Digital Direction Finder for Traffic Control

Permissible humidity	max. 95 % cycl. test at +25 °C/+55 °C in line with DIN EN 60068-2-30	Maximum wind speed	R&S®ADD090(M)/ R&S®GX090(M)	275 km/h (without ice deposit) 210 km/h (with 30 mm radial ice deposit)
Mechanical resistance		Dimensions (W × H × D)	R&S®EBD100M	219 mm × 147 mm × 460 mm (8.62 in × 5.79 in × 18.11 in)
Vibration			R&S®ESMB	210 mm × 132 mm × 460 mm (8.27 in × 5.20 in × 18.11 in)
Sinusoidal	5 Hz to 55 Hz, 0.15 mm amplitude, in line with DIN EN 60068-2-6		R&S®GX090C	470 mm × 180 mm × 400 mm (18.50 in × 7.09 in × 15.75 in)
Random	10 Hz to 500 Hz, 1.9 g RMS, in line with DIN EN 60068-2-36		R&S®ADD090M	(center-mount antenna) diameter: 2.5 m (98.43 in), height: 1.5 m (59.06 in)
Shock	40 g shock spectrum, in line with DIN EN 60068-2-27		R&S®ADD090	(top-mount or side-mount) diameter 2 m (78.74 in), height 0.8 m (31.50 in), (with lightning rod: 2 m (78.74 in))
Class of protection		Weight	R&S®EBD100M	approx. 10 kg (22.05 lb)
R&S®ADD090(M)/ R&S®GX090(M)	IP 55, in line with DIN EN 40050		R&S®GX090C	approx. 6 kg (13.23 lb)
Lightning protection			R&S®ESMB	approx. 8 kg (17.64 lb)
R&S®ADD090(M)/ R&S®GX090(M)	against direct lightning strokes in line with IEC 1024-1, class of protection IV, (\bar{i} = 100 kA, di/dt = 100 kA/ms)		R&S®ADD090M	approx. 157 kg (346.13 lb)
EMC	in line with EN 50081-1, EN 61000-6-2, EN 55022 class B		R&S®ADD090	approx. 40 kg (88.18 lb) (incl. lightning rod)
Power supply			R&S®GX090(M)	approx. 10 kg (22.05 lb)
AC	100/120/230/240 V AC, +10 %/–12 %, 47 Hz to 440 Hz, 40 VA, overvoltage-protected, in line with VDE 160			
DC				
R&S®EBD100M/R&S®GX090C/ R&S®ESMB	10 V to 32 V, 20 W			
R&S®ADD090(M)/ R&S®GX090(M)	18 V DC, max. 0.3 A (from R&S®EBD100M DF processor for cable lengths ≤300 m)			

3

Chapter Overview

Type Index

Main Menu

Ordering information

Digital Direction Finder			Accessories		
With R&S®ADD090, without interference canceller	R&S®DDF100M1	4064.0120.12	Antenna connecting cable		on request
With R&S®ADD090, with interference canceller	R&S®DDF100M1	4064.0120.22	Device Control for R&S®DDF100M	R&S®DDF1M-CTL	3020.8835.02
With R&S®ADD090M, without interference canceller	R&S®DDF100M2	4064.0120.14	RAMON Basic Module	R&S®RA-BASIC	3020.9490.02
With R&S®ADD090M, with interference canceller	R&S®DDF100M2	4064.0120.24			