



R&S® SMART SENSOR TECHNOLOGY – ready for a wide variety of applications

Contents of Chapter 7

Designation	Frequency range	Type	Description	Page
Power Meter		R&S®NRP	Base unit for power sensors in R&S®SMART SENSOR TECHNOLOGY	290
Power Sensors				
200 pW to 200 mW	10 MHz to 8 GHz	R&S®NRP-Z11	Universal applicable 3-path sensors in R&S®SMART SENSOR TECHNOLOGY Can be used as standalone measuring instruments even without the basic unit	290
	10 MHz to 18 GHz	R&S®NRP-Z21		
	9 kHz to 6 GHz	R&S®NRP-Z91		
2 nW to 2 W	10 MHz to 18 GHz	R&S®NRP-Z22	Same characteristics as R&S®NRP-Z21 but designed for measurement of higher power values	
20 nW to 15 W	10 MHz to 18 GHz	R&S®NRP-Z23		
60 nW to 30 W	10 MHz to 18 GHz	R&S®NRP-Z24		
1 μW to 100 mW	DC to 18 GHz	R&S®NRP-Z51	Thermocouple sensors with USB interface	
	DC to 40 GHz	R&S®NRP-Z55		



Contents Overview

Chapter Overview

Type Index

R&S Addresses



Contents of Chapter 7

Designation	Frequency range	Type	Description	Page
Terminating Power Meters		R&S®NRVS	Precision power meter with IEC/IEEE-bus interface for use in labs and systems	294
		R&S®NRVD	Versatile precision power meter with IEC/IEEE-bus interface and two channels	296
Power Sensors			For all terminating power meters and RF millivoltmeters (for R&S®URV5: R&S®NRV-Z1 to -Z6 only)	298
100 pW to 20 mW	100 kHz to 40 GHz	R&S®NRV-Z1/-Z3/-Z4/-Z6/-Z15	Highly sensitive diode sensors 50 Ω for power measurement with wide dynamic range	
10 nW to 0.5 W 1 μW to 30 W	100 kHz to 18 GHz DC to 40 GHz	R&S®NRV-Z2/-Z5 R&S®NRV-Z51 to 55	Sensitive diode power sensors Thermocouple sensors for precision power measurements and measurement of average power of modulated signals	
1 μW to 20 mW 100 μW to 2 W 1 mW to 20 W	30 MHz to 6 GHz	R&S®NRV-Z31 R&S®NRV-Z32 R&S®NRV-Z33	Peak power sensors for measuring transmitter power of TDMA mobile radio equipment (GSM 900/1800/1900), TV sync pulse power and for general applications	
Power Reflection Meter		R&S®NRT	Universal power and reflection meter for use in service, installation, labs and systems, AC supply and battery operation; IEC/IEEE bus and RS-232-C interface, simultaneous display of power and reflection	301
Power Sensors 0.7 mW to 120 (300) W 0.3 mW to 2000 W 200 kHz to 1 GHz	200 MHz to 4 GHz	R&S®NRT-Z43, -Z44 R&S®NAP-Z3 to -Z8 R&S®NAP-Z10, -Z11	Power sensors for all common frequency bands and digital networks; measurement of average power and peak envelope power (PEP) of modulated signals (depending on sensor)	301
Power Reflection Meter		R&S®NAS	Low-cost measuring instrument for use in system installation, with analog display of power and SWR, battery operation; handy, easy to operate	305
Power Sensors 10 mW to 1200 W	1 to 1990 MHz	R&S®NAS-Z1/-Z2/-Z3 R&S®NAS-Z5/-Z6/-Z7	Power sensors for all common communication bands, also for GSM 900/1800/1900	306
RF Millivoltmeters, Level Meters		R&S®URV35	Voltage, level and power measurements in service, field service and labs, AC supply and battery operation; high measurement convenience through digital display combined with intelligent moving-coil meter	307
		R&S®URV5 R&S®URV55	RF millivoltmeter with IEC/IEEE-bus interface and two channels RF millivoltmeter with IEC/IEEE-bus interface for use in labs and systems	308 309
Voltage probes 200 mV to 10 V 200 mV to 10 V 2 mV to 100 V	20 kHz to 1 GHz 9 kHz to 3 GHz 100 kHz to 3 GHz	R&S®URV5-Z7 R&S®URV5-Z2 R&S®URV5-Z4	For all RF millivoltmeters/level meters and terminating power meters: Large variety of accessories for measurements on noncoaxial and coaxial lines Insertion units 50 Ω for voltage measurements on coaxial lines with load connected	311
1 mV to 100 V	DC	R&S®URV5-Z1	DC probe for low-load measurements on RF modules	
Broadband Voltmeters 50 μV to 300 V	DC, 0.02 Hz to 30 MHz	R&S®URE3	RMS and peak voltmeter with IEC/IEEE-bus interface for use in labs, production and systems; high measurement speed, low measurement uncertainty, DC and AC coupling, frequency measurement	313
50 μV to 300 V	DC, 10 Hz to 25 MHz	R&S®URE2	Low-cost RMS voltmeter similar to R&S®URE3, but without peak and frequency measurement	313



Contents Overview

Chapter Overview

Type Index

R&S Addresses





Contents Overview

Chapter Overview

Type Index

R&S Addresses



Power Meter R&S®NRP

With R&S®SMART SENSOR TECHNOLOGY – ready for a wide variety of applications



Brief description

Top measurement accuracy plus a dynamic range up to 90 dB for broadband signals of any modulation are the most important characteristics of the Power Meter R&S®NRP. The versatile sensors in R&S®SMART SENSOR TECHNOLOGY are a priceless investment if you wish to meet future requirements such as the broadband modulation types of third-generation mobile radio. In addition, the R&S®NRP is also suitable of handling the RF bandwidths beyond 100 MHz that are already under discussion for wireless LAN.

Main features

- ◆ Intelligent sensors – simply plug in and measure
- ◆ Innovative multipath sensor technology
- ◆ 90 dB dynamic range
- ◆ High measurement accuracy and speed
- ◆ Multislot measurements for common time division systems (e.g. GSM/EDGE, DECT)
- ◆ Handling of external components through Γ and s-parameter correction

- ◆ Simultaneous operation of up to 4 sensors on basic unit
- ◆ Remote control via IEEE bus and USB
- ◆ Battery operation (optional)
- ◆ Ethernet LAN interface (optional)
- ◆ Operation of sensor directly from PCs via USB interface
- ◆ 2-year calibration cycle

Universal basic unit

The R&S®NRP is small, lightweight and rugged, and the optional battery pack ensures several hours of operation without line power. Depending on requirements, it can be fitted with one, two or four measurement inputs. The IEEE/IEC-bus connector and USB connector are a standard feature as are the trigger input and the analog measurement output.

The user interface of the power meter takes its cue from the PC world. The high-resolution graphical display can show as many as four measurement results at the same time. The user can choose which results to display – either the data from the sensors (with a maximum of four connected simultaneously) or from different timeslots of a TDMA signal measured by means of one sensor.

Intelligent sensors

The sensors currently available cover a frequency range from DC to 40 GHz and measure power between 200 pW and 30 W. All sensors are independent instruments remotely controlled via the USB and can be operated from an R&S NRP base unit, various other instruments such as the R&S SMU or the R&S FSP, or from a PC.

Universal power sensors

These sensors are based on multipath architecture and multiple diode technology. They provide high-accuracy, high-speed measurements of the power parameters most frequently needed, i.e. average power, average burst power, timeslot power, and power-versus-time profile. With a dynamic range up to 90 dB and a frequency range up to 18 GHz, these sensors cover a variety of applications.

Average power sensors

Based on multipath architecture, these sensors measure the average power of modulated and unmodulated signals over a wide dynamic range with high accuracy.



Contents Overview

Chapter Overview

Type Index

R&S Addresses





Contents Overview

Chapter Overview

Type Index

R&S Addresses



Power Meter R&S®NRP

Thermal power sensors

These power sensors provide extremely high accuracy for reference applications in the frequency range up to 40 GHz. They are based on the tried-and-tested thermal sensor technology from Rohde & Schwarz also employed by the R&S NRV family.

High system accuracy

Precise calibration

The accuracy of a microwave power measurement essentially depends on the characteristics of the sensor. The deviation of each manufactured sensor from the ideal characteristic is measured and then the value is stored in the sensor as a data record.

A power sensor can only be as good as the measuring instruments used to calibrate it. This is why the standards employed by Rohde & Schwarz are directly traceable to the power standards of the German Standards Laboratory (PTB).

High measurement accuracy – even with modulated signals

The concept of R&S®*SMART SENSOR TECHNOLOGY™* comprises an entire series of measures intended to make the multiple-path diode sensors similar to thermal sensors in behaviour. This includes very accurate measurement of average power, regardless of modulation, as well as high immunity to incorrect weighting of harmonics, spurious and other interference signals.

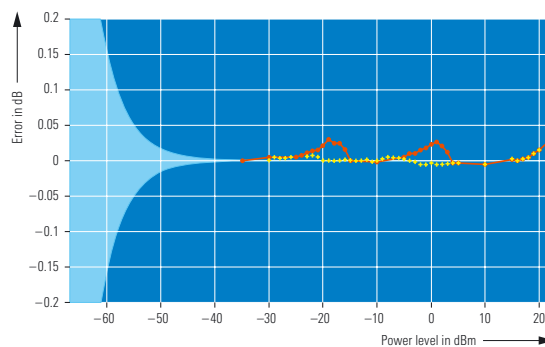

Modulation-related errors of an R&S®NRP-Z11 or R&S®NRP-Z21 power sensor for a 3GPP test signal (test model 1-64) compared to a CW signal of the same magnitude. Red: default setting; yellow: transition area between measurement paths shifted by -6 dB; light blue: uncertainty caused by noise (modulation effect below -30 dBm negligible)

Γ correction

The most important source of error in power measurements on RF and microwave signals is the mismatch of source and sensor. To minimize the influence of mismatched sources, the standing wave ratio (SWR) at the sensor end was reduced to the extent technically feasible. Additionally the complex reflection coefficient of the source can be transmitted to the sensor via the USB data interface, and the sensor can correct the matching error by means of Γ correction, taking into consideration its own low impedance mismatch.

S-parameter correction

Especially in production facilities, the sensor is not direct connected with the source but via preceded attenuators or directional couplers. With the help of a software tool, the complete s-parameter data set of the twoport connected ahead

can be loaded into the sensor's memory via the USB data interface. The data format required (s2p/Touchstone) is provided by any vector network analyzer. After the source's complex reflection coefficient has been transmitted (optionally), a perfectly corrected reading is obtained.

Use on a PC

The sensors of the R&S®NRP-Z series can be used as standalone measuring instruments even without the basic unit. In addition to the power sensor itself, they include a CPU that controls the sensor, processes the measurement results and operates the interface. All measurement data and settings are transmitted via a digital USB interface. In order to control the R&S®NRP power sensors via a PC several drivers and a user interface (Power Viewer) with basic functionality are available.

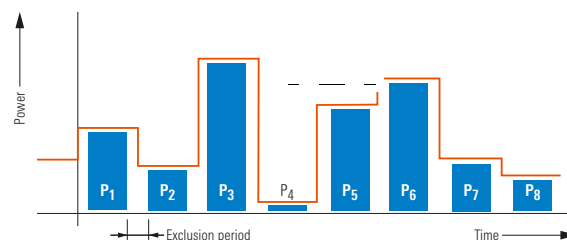

Multislot measurement: for the most common time division methods (e.g. GSM/EDGE, DECT), average power can be measured in all timeslots at the same time



Contents Overview

Chapter Overview

Type Index

R&S Addresses



Power Meter R&S®NRP

Two adapters are available for connection to the hardware

- ◆ The passive USB Adapter R&S®NRP-Z4 provides all basic functions, as it handles the transmission of settings and measurement data as well as the power supply of the sensor
- ◆ The active USB Adapter R&S®NRP-Z3 has been developed for applications requiring external triggering of the power sensor. It also offers a separate power supply

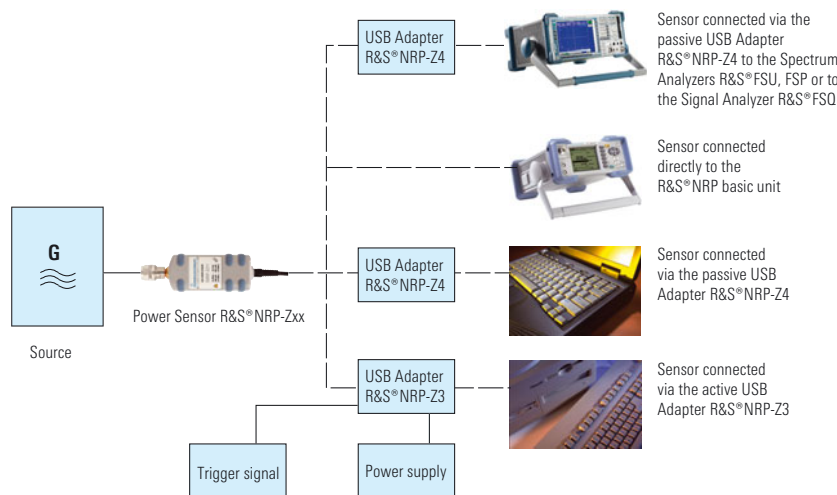

Four possibilities of connecting the R&S®NRP sensors

Specifications in brief

You will find detailed and binding data on the enclosed CD

(../DATASHEET/NRP.pdf), or, for the latest updates, visit www.rohde-schwarz.com, search term: NRP

Power sensors

Model	Frequency range	Power measurement range, max. power	SWR	Rise time, video bandwidth	Zero offset	Display noise	Linearity in dB (15°C to 35 °C)	Calibration uncertainty in dB				
Universal power sensors												
NRP-Z11	10 MHz to 8 GHz	200 pW to 200 mW 400 mW (AVG)	10 MHz to 2,4 GHz: <1,13 >2,4 GHz to 8 GHz: <1,20	<8 µs >50 kHz	64 pW	40 pW	0,022 to 0,097	0,047 to 0,083				
NRP-Z21	10 MHz to 18 GHz	1 W (PK, 10 µs)	>8 GHz to 18 GHz: <1,25						0,022 to 0,135	0,047 to 0,123		
NRP-Z22	10 MHz to 18 GHz	2 nW to 2 W 3 W (AVG) 10 W (PK, 10 µs)	10 MHz to 2,4 GHz: <1,14 >2,4 GHz to 8 GHz: <1,20 >8 GHz to 12,4 GHz: <1,25 >12,4 GHz to 18 GHz: <1,30						0,022 to 0,152			
NRP-Z23	10 MHz to 18 GHz	20 nW to 15 W 18 W (AVG) 100 W (PK, 10 µs)	10 MHz to 2,4 GHz: <1,14 >2,4 GHz to 8 GHz: <1,25 >8 GHz to 12,4 GHz: <1,30						7 nW	4 nW	0,022 to 0,135	0,072 to 0,180
NRP-Z24	10 MHz to 18 GHz	60 nW to 30 W 36 W (AVG) 300 W (PK, 10 µs)	>12,4 GHz to 18 GHz: <1,41						20 nW	13 nW	0,022 to 0,135	
Average power sensors												
NRP-Z91	9 kHz to 6 GHz	200 pW to 200 mW 400 mW (AVG) 1 W (PK, 10 µs)	9 kHz to 2,4 GHz: <1,13 >2,4 GHz to 6 GHz: <1,20	---	64 pW	40 pW	0,022 to 0,097	0,047 to 0,083				
Thermal power sensors												
NRP-Z51	DC to 18 GHz		DC to 2,4 GHz: <1,10 >2,4 GHz to 12,4 GHz: <1,15 >12,4 GHz to 18 GHz: <1,20	---				0,047 to 0,098				
NRP-Z55	DC to 40 GHz	1 µW to 100 mW 300 mW (AVG) 10 W (PK, 1 µs)	>18 GHz to 26,5 GHz: <1,25 >26,5 GHz to 40 GHz: <1,30	---	33 nW	20 nW	0,020	0,053 to 0,112				



Contents Overview

Chapter Overview

Type Index

R&S Addresses



Power Meter R&S®NRP

Other power sensor characteristics

Measurement functions

Continuous average	continuous measurement of average power; duration of measurement window can be selected
Burst average (NRP-Z1x/-Z2x only)	measurement of average burst power with automatic burst detection
Timeslot/gate (NRP-Z1x/-Z2x only)	measurement of average burst power in one or more timeslots
Scope (NRP-Z1x/-Z2x only)	measurement of power versus time

Averaging filter

Average factor	1...2 ¹⁶
Automatic modes	Normal (filter setting depends on power to be measured and on resolution) Fixed Noise (filter set to specified noise content)

Correction functions

Frequency	calibration factors relevant for test frequency are taken into account
Attenuation	measurement result is corrected by means of fixed factor (dB offset)
S-parameter	component connected ahead of sensor is taken into account by loading its S parameter data set into sensor
Gamma	influence of mismatched sources is reduced

Triggering

Source	Internal, External, Bus, Immediate, Hold
Slope	pos./neg.
Level (internal)	-40 dBm to +23 dBm (NRP-Z11, -Z21) -30 dBm to +33 dBm (NRP-Z22) -19 dBm to +42 dBm (NRP-Z23) -14 dBm to +45 dBm (NRP-Z24)

Sensor interface to host

Power supply	+5 V/200 mA typ. (USB high-power device)
Remote control	as a USB device (function) in full-speed mode, compatible with USB 1.0/1.1/2.0 specifications
Trigger input	differential (0/+3.3 V)
Dimensions (W × H × L)	length incl. connecting cable: ~1.6 m
R&S®NRP-Z11/21/51/55/91	48 mm × 31 mm × 170 mm
R&S®NRP-Z22	48 mm × 31 mm × 214 mm
R&S®NRP-Z23	60 mm × 54 mm × 285 mm
R&S®NRP-Z24	60 mm × 54 mm × 344 mm
Weight	<0.3 kg

Manual operation	Windows-oriented menus with hotkeys for the most important functions
Remote control	IEC/IEEE 488 bus, USBTMC, Ethernet/VXI11
Power supply	220 V to 240 V (±10%), 50 Hz to 60 Hz (±10%) 100 V to 120 V (±10%), 50 Hz to 400 Hz (±10%)
Apparent power	<80 VA
Dimensions (W × H × D)	274 mm × 112 mm × 267 mm
Weight	<3.0 kg

R&S NRP basic unit

Measurement channels 1 to 4

Measurement functionality single-channel

See sensor specifications, plus:
relative measurement referenced to result or user-selectable reference value, storage of minima and maxima (Max, Min, Max-Min), limit monitoring

Display, absolute	in W, dBm and dBμV
Display, relative	in dB, as change in percent (Δ%) or as quotient

Measurement functionality multichannel

Simultaneous measurement in up to 4 channels; ratio, relative ratio or difference of results of 2 channels can be displayed (for all functions except Scope)

Display	
Difference	in W
Ratio	in dB, as change in percent (Δ%), as quotient or as one of the following matching parameters: SWR, return loss, reflection coefficient
Relative ratio	in dB, as change in percent (Δ%) or as quotient

Display
LC graphics screen ¼ VGA (320 x 240) pixel, monochrome, transfective

Backlighting
brightness adjustable

Measurement results
up to 4 results with additional information (Min, Max, Max-Min, frequency) can simultaneously be displayed in separate windows

Representation	digital, digital and analog
Resolution	
Digital values	selectable in 4 steps: 0.001 dB to 1 dB
Analog display	depending on user-definable scale end values

Ordering information

Power Meter	R&S®NRP	1143.8500.02
--------------------	---------	--------------

Power Sensors

200 pW to 200 mW, 10 MHz to 8 GHz	R&S®NRP-Z11	1138.3004.02
200 pW to 200 mW, 10 MHz to 18 GHz	R&S®NRP-Z21	1137.6000.02
200 pW to 200 mW, 9 kHz to 6 GHz	R&S®NRP-Z91	1168.8004.02
2 nW to 2 W, 10 MHz to 18 GHz	R&S®NRP-Z22	1137.7506.02
20 nW to 15 W, 10 MHz to 18 GHz	R&S®NRP-Z23	1137.8002.02
60 nW to 30 W, 10 MHz to 18 GHz	R&S®NRP-Z24	1137.8502.02
1 μW to 100 mW, DC to 18 GHz	R&S®NRP-Z51	1138.0005.02
1 μW to 100 mW, DC to 40 GHz	R&S®NRP-Z55	1138.2008.02

Options

Sensor Check Source	R&S®NRP-B1	1146.9008.02
Second Sensor Input (B)	R&S®NRP-B2	1146.8801.02
Battery Supply	R&S®NRP-B3	1146.8501.02
LAN Interface 10/100 Base T	R&S®NRP-B4	1146.9308.02
3rd and 4th Sensor Inputs (C, D)	R&S®NRP-B5	1146.9608.02
Rear-Panel Sensor Inputs A and B ¹⁾	R&S®NRP-B6	1146.9908.02

Extras

Sensor Extension Cable to 5 m	R&S®NRP-Z2	1146.6750.05
Sensor Extension Cable to 10 m	R&S®NRP-Z2	1146.6750.10
USB Adapter (active)	R&S®NRP-Z3	1146.7005.02
USB Adapter (passive)	R&S®NRP-Z4	1146.8001.02
19" Rack Adapter (for 1 R&S®NRP + empty case)	R&S®ZZA-T26	1109.4387.00
19" Rack Adapter (for 2 NRPs)	R&S®ZZA-T27	1109.4393.00

¹⁾ Not in conjunction with the R&S®NRP-B5.



Contents Overview

Chapter Overview

Type Index

R&S Addresses



Power Meter R&S®NRVS

DC to 40 GHz

100 pW to 30 W

Power (average, pulse, PEP), level
and DC voltage measurements

Brief description

Power Meter R&S®NRVS is an ideal instrument for a great variety of power measurement applications in labs and systems. Thanks to its intelligent sensors with calibration data memory and thermocouple sensors, which make adjustments by the user superfluous, R&S®NRVS provides at all times high-precision measurements free of operator's errors.

Main features

- ◆ Fast power, level and voltage measurements
- ◆ Intelligent R&S®NRV-Z probes and R&S®URV5-Z sensors: plug and play
- ◆ IEC/IEEE-bus interface
- ◆ DC frequency input for tracking frequency-response correction
- ◆ Analog output
- ◆ Storage of 20 complete instrument setups
- ◆ 13 digital filters for noise suppression, automatic or manual filter selection
- ◆ Sensor check source (optional)

Characteristics

Display

Measurement results, units and various items of information are displayed on a large easy-to-read 4½-digit LC display in three selectable steps of resolution.

Pulse power

If pulse-modulated RF signals are measured, R&S®NRVS calculates the pulse peak power from the measured average power and the entered pulse duty factor, and reads out the result directly. The use of Peak Power Sensors R&S®NRV-Z31 and -Z33 for measuring the peak envelope power (PEP) is highly recommended.

Measurement rate

The attainable measurement rate not only depends on the type of sensor used but also on the setting of the averaging filter. R&S®NRVS automatically makes the appropriate settings by determining the optimum averaging time required for a steady readout as a function of level and selected resolution. This automatic selection can be switched off.

Measuring heads

The range of measuring heads includes thermocouple power sensors as well as highly sensitive diode power sensors, peak power sensors (from page 298), probes and insertion units for voltage measurement (from page 311).

R&S®NRVS therefore covers a frequency range from DC to 40 GHz and a power span from 100 pW to 30 W.

The power sensors are not specifically designed for R&S®NRVS and can therefore be freely used with any of the Rohde & Schwarz power meters and voltmeters.



Contents Overview

Chapter Overview

Type Index

R&S Addresses



Power Meter R&S®NRVS

Specifications in brief,
power sensors page 298, voltage probes page 311

You will find detailed and binding data on the enclosed CD
(../DATASHEET/NRVS.pdf), or, for the latest updates, visit
www.rohde-schwarz.com, search term: NRVS

Measurement functions	average power, pulse power, peak envelope power, AM, reflection, DC voltage (depending on sensor)
Frequency and level range	DC to 40 GHz, 100 pW to 30 W 9 kHz to 3 GHz, 200 mV to 1000 V (depending on sensor)
Probes and sensors	all R&S®NRV sensors and URV5 probes
Display	LCD for digits, units, menu-guided operation and analog display, adjustable backlighting
Display of results	single-channel (with optional display of correction frequency) or dualchannel
Absolute readout	W, dBm, V, dBmV,
Relative readout	dB, %W or %V relative to a stored reference value
Analog display	automatic or with selectable scale
Digital display and resolution	max. 4½ digits, resolution selectable (0.1/0.01/0.001 dB)
Display filtering	averaging over 1 to 512 readings to reduce display noise; manual or automatic setting depending on measurement range and resolution
Display noise	see sensors from page 311/298
Measurement rate	see table on page 300
Accuracy (without sensors)	
18°C to 28°C	0.4% +1 digit
10°C to 40°C	0.9% +1 digit
0°C to 50°C	1.4% +1 digit
Zero adjustment	manual or via IEC/IEEE bus, duration approx. 4 s
Frequency response	sensor-specific calibration data taken into account; numerical entry of test frequency (keyboard or via IEC/IEEE bus) or by frequency-proportional DC voltage
correction	
Attenuation compensation	external attenuation or gain taken into account; data entry via keyboard or IEC/IEEE bus, range ±200 dB

Entry of reference value	measured value on keystroke or numerical entry via keypad or IEC/IEEE bus
Reference impedance	for conversion between voltage and power, automatic readout of reference impedance from sensor data memory or numerical entry via keyboard or IEC/IEEE bus (for RF probe)
Remote control	IEC 625 (IEEE 488), control of all instrument functions
Interface functions	SH1, AH1, T6, L4, SR1, RL1, DC1, DT1, PPO
DC frequency input	
Connector	BNC
Input voltage range	±12 V, linear with selectable scale
DC output	
Connector	BNC, $R_{out} = 1 \text{ k}\Omega$, EMF proportional to analog display
Left-/right-hand full-scale value	corresponding to 0/+3 V
Accuracy	±5 mV
Channels	1, 2
Sensor check source	option R&S®NRVS-B1
Output power	1 mW ±0.7%
Frequency	50 MHz
VSWR	1.05
RF connector	N female
General data	
Power supply	115 V +15/–22%, 47 Hz to 63 (440) Hz; 230 V +15/–22%, 47 Hz to 63 Hz, 13 VA
Dimensions (W × H × D)	219 mm × 103 mm × 350 mm
Weight	3.2 kg

Ordering information

Power Meter	R&S®NRVS	1020.1809.02
Options		
Sensor Check Source	R&S®NRVS-B1	1029.2908.02
Recommended extras		
Rack adapter	R&S®ZZA-97	0827.4527.00
Transit case	R&S®UZ-24	1029.3379.02
Service Kit	R&S®NRVS-S1	1029.2708.02



Contents Overview

Chapter Overview

Type Index

R&S Addresses





Contents Overview

Chapter Overview

Type Index

R&S Addresses



Dual-Channel Power Meter R&S®NRVD

DC to 40 GHz

100 pW to 30 W

Power, level and voltage

measurements; attenuation and

reflection measurements:

precise, versatile, convenient

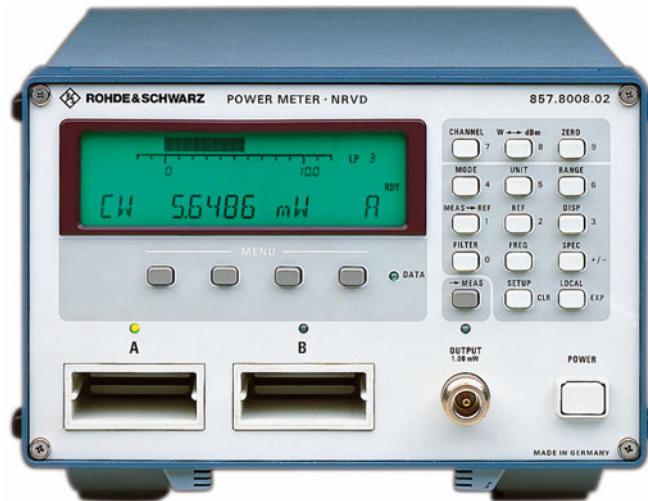

Brief description

R&S®NRVD functions like two independent R&S®NRVS power meters in one enclosure performing simultaneous measurements and exchanging data with each other. The two channels can be set separately so that two completely different measurements can be carried out at the same time. The two measured values can also be related to each other for read-out of reflection coefficient, SWR or return loss, for instance.

Main features

- ◆ Two independent channels performing simultaneous measurements
- ◆ LC display with variable backlighting
- ◆ IEC/IEEE-bus interface (optionally SCPI or compatible with URV5)
- ◆ 13 digital filters for noise suppression, automatic or manual filter selection
- ◆ Considering frequency response of external components (attenuators or direction couplers inserted before sensor)

- ◆ Storage of 20 complete instrument setups
- ◆ Input/output option with DC frequency input, analog outputs, trigger input, ready output
- ◆ Large variety of intelligent sensors: plug and play
- ◆ Rear connectors for sensors
- ◆ Sensor check source

Characteristics

Display

Measurement results are displayed with selectable resolution on a five-digit LCD with adjustable backlighting. The values measured in the two channels or one measured value plus an additional item of information are displayed.

The R&S®NRVD measures pulse-modulated RF signals like the R&S®NRVS. Additionally, the modulation depth of amplitude-modulated signals can be determined from the power variation. After entering the source matching, the expected uncertainty for thermocouple power sensors can be displayed.

Measurement rate

See Power Sensors R&S®NRV-Zx, page 300.

Sensor check source

It supplies a highly accurate, low-distortion 50 MHz signal of 1 mW (0 dBm) power for checking the sensors.

Input/Output Option R&S®NRVD-B2

Each measurement channel has an analog output with selectable scaling for connection of a recorder or for control purposes. Simple automatic test routines can be implemented with the aid of the trigger input and the ready output. Another input serves for taking up the frequency-proportional DC voltage from a sweep generator for tracking frequency-response correction.



Contents Overview

Chapter Overview

Type Index

R&S Addresses





Contents Overview

Chapter Overview

Type Index

R&S Addresses



Dual-Channel Power Meter R&S®NRVD

Specifications in brief,
power sensors page 298, voltage probes page 311

You will find detailed and binding data on the enclosed CD
(../DATASHEET/NRVD.pdf), or, for the latest updates, visit
www.rohde-schwarz.com, search term: NRVD

Measurement functions	average power, pulse power, peak envelope power, AM, reflection, DC voltage (depending on sensor)
Frequency and level range	DC to 40 GHz, 100 pW to 30 W 9 kHz to 3 GHz, 200 mV to 1000 V (depending on sensor)
Probes and sensors	all R&S®NRV sensors and R&S®URV5 probes
Display	LCD for digits, units, menu-guided operation and analog display, adjustable backlighting
Display of results	single-channel (with optional display of correction frequency) or dualchannel
Absolute readout	W, dBm, V, dBmV, dBV
Relative readout R&S®NRVD	dB, difference, percent and ratio, relative to a stored reference value or to the second measurement channel; VSWR, reflection coefficient, return loss in dB, AM modulation depth
Analog display	automatic or with selectable scale
Digital display and resolution	max. 4½ digits, resolution selectable (0.1/0.01/0.001 dB)
Display filtering	averaging over 1 to 512 readings to reduce display noise; manual or automatic setting depending on measurement range and resolution
Display noise	see sensors from page 311/298
Measurement rate	see table on page 300
Accuracy (without sensors)	
18°C to 28°C	0.3% +1 digit
10°C to 40°C	0.8% +1 digit
0°C to 50°C	1.3% +1 digit
Zero adjustment	manual or via IEC/IEEE bus, duration approx. 4 s
Frequency response correction	sensor-specific calibration data taken into account; numerical entry of test frequency (keyboard or via IEC/IEEE bus) or by frequency-proportional DC voltage
Attenuation compensation	external attenuation or gain taken into account; data entry via keyboard or IEC/IEEE bus, range ±200 dB

Entry of reference value	measured value on keystroke or numerical entry via keypad or IEC/IEEE bus
Reference impedance	for conversion between voltage and power, automatic readout of reference impedance from sensor data memory or numerical entry via keyboard or IEC/IEEE bus (for RF probe)
Remote control	IEC625 (IEEE488), SCPI, control of all instrument functions
Interface functions	SH1, AH1, T6, L4, SR1, RL1, DC1, DT1, PP0, PP1
Input/Output Option R&S®NRVD-B2	2 simultaneous DC voltage outputs, DC frequency input, trigger input (TTL, active low), ready output (TTL, active high)
DC frequency input, connector	BNC
Input voltage range	±12 V, linear with selectable scale
DC output, connector	BNC, $R_{out} = 1 \text{ k}\Omega$, EMF proportional to analog display
Left-/right-hand full-scale value	corresponding to 0/+3 V
Accuracy	±5 mV
Channels	1, 2
Sensor check source	
Output power	1 mW ±0.7%
Frequency	50 MHz
VSWR	≤1.03
RF connector	N female
General data	
Power supply	100/120/220 V ±10%, 230 V –6/+15%;
47 Hz to 400 Hz (25 VA)	
Dimensions (W × H × D)	219 mm × 147 mm × 350 mm
Weight	4.5 kg

Ordering information

Dual-Channel Power Meter	R&S®NRVD	0857.8008.02
Option		
Input/Output Option	R&S®NRVD-B2	0857.8908.02
Recommended extras		
Rack adapter	R&S®ZZA-98	827.4533.00
Service Kit	R&S®NRVD-S1	1029.2808.02



Contents Overview

Chapter Overview

Type Index

R&S Addresses





Contents Overview

Chapter Overview

Type Index

R&S Addresses



Power Sensors R&S®NRV-Z

Brief description

For all power measurements with instruments from the R&S®URV/R&S®NRV families, 15 power sensors in all cover the frequency range from DC to 40 GHz. Three classes of sensitivity allow direct measurement of any power between 100 pW and 30 W. A 75-Ω sensor is available for TV and video applications.

The calibration data memory integrated in the sensor contains all the relevant information. With the sensor plugged in, a fully calibrated meter is ready for measurements. The calibration of all sensors can be traced to the relevant standards of the Federal German Bureau of Standards.

For calculating the total measurement uncertainty of the source power delivered to Z_0 load the following factors have to be taken into account: mismatch uncertainty, calibration uncertainty, linearity error, meter noise, zero offset, temperature effect, pulse measurement uncertainty (peak power sensors only) and measurement uncertainty of basic unit.



Calibration data for each sensor are stored in an EPROM in the sensor's connector

Overview of models

High-Sensitivity Sensors R&S®NRV-Z1/-Z3/-Z4/-Z6/-Z15

These sensors measure the true RMS power from about 100 pW to 10 μW and can be used in this level range for signals with harmonic contents, noisy or modulated signals. For sinewave signals, the measurement range extends to 20 mW (13 mW into 75 Ω).

Medium-Sensitivity Sensors R&S®NRV-Z2/-Z5

Based on diode detectors with 20 dB attenuator, these sensors provide true RMS power measurement in the range

from 10 nW to 1 mW and up to 500 mW for sinewave signals. Compared to thermocouple sensors, shorter measurement times can be attained with these sensors.

Thermocouple Power Sensors R&S®NRV-Z51 to -Z55

They measure the average power irrespective of the waveform and therefore are also suitable for spread spectrum, IS-95 CDMA and WCDMA measurements, irrespective of the peak-to-average power ratio of the waveform concerned. Being individually calibrated, these sensors feature an unrivalled linearity over the entire dynamic range.

Peak Power Sensors R&S®NRV-Z31 to -Z33

These sensors measure the peak envelope power (PEP) of modulated or pulsed signals. The TDMA models 04 of the sensors allow fast and precise measurement of the transmitter power of mobile stations in GSM 900/1800/1900 networks. Models 03 are suitable for measuring the sync pulse power of TV transmitters. Model .02 with a minimum pulse repetition frequency of 10 Hz is designed for general applications. Model .05 of R&S®NRV-Z32 enables measurement of the power peak value of mobile stations to NADC and PDC standard.

Specifications in brief

Model	Frequency range	Power range, max. power	Max. SWR (reflection coefficient)	Zero offset (±)	Meter noise	Linearity uncertainty in dB	Calibration uncertainty in dB
R&S®NRV-Z1 N; 50 Ω	10 MHz to 18 GHz	200 pW to 20 mW	0.01 to 1 GHz: 1.06 (0.03)	100 pW	40 pW	0.03	0.07
		100 mW (AVG)	>1 to 2 GHz: 1.13 (0.06)				0.07
		100 mW (PK)	>2 to 4 GHz: 1.27 (0.12)				0.08
			>4 to 18 GHz: 1.41 (0.17)				0.08 to 0.15
R&S®NRV-Z2 N; 50 Ω	10 MHz to 18 GHz	20 nW to 500 mW	0.01 to 4 GHz: 1.05 (0.024)	10 nW	4 nW	0.03	0.07
		2 W (AVG)	>4 to 8 GHz: 1.1 (0.048)				0.07
		10 W (PK)	>8 to 12.4 GHz: 1.15 (0.07)				0.07
			>12.4 to 18 GHz: 1.2 (0.09)				0.09 to 0.13



Contents Overview

Chapter Overview

Type Index

R&S Addresses





Contents Overview

Chapter Overview

Type Index

R&S Addresses



Power Sensors R&S®NRV-Z

Specifications in brief

Model	Frequency range Min. pulse width Min. PRF	Power range, max. power	Max. SWR (reflection coefficient)	Zero offset (±)	Meter noise	Linearity uncertainty in dB	Calibration uncertainty in dB
R&S®NRV-Z3 N; 75 Ω	1 MHz to 2.5 GHz	100 pW to 13 mW 70 mW (AVG) 70 mW (PK)	1 to 100 MHz: 1.11 (0.05) >0.1 to 1 GHz: 1.11 (0.05) >1 to 2.5 GHz: 1.2 (0.09)	40 pW	16 pW	0.03	0.06 0.07 0.07
R&S®NRV-Z4 N; 50 Ω	100 kHz to 6 GHz	100 pW to 20 mW 100 mW (AVG) 100 mW (PK)	0.1 to 100 MHz: 1.05 (0.024) >0.1 to 2 GHz: 1.1 (0.048) >2 to 4 GHz: 1.2 (0.09) >4 to 6 GHz: 1.35 (0.15)	50 pW	20 pW	0.03	0.05 to 0.06 0.06 0.06 0.07
R&S®NRV-Z5 N; 50 Ω	100 kHz to 6 GHz	10 nW to 500 mW 2 W (AVG), 10 W (PK)	100 kHz to 4 GHz: 1.05 (0.024) >4 to 6 GHz: 1.1 (0.048)	5 nW	2 nW	0.03	0.05 to 0.06 1.7 to 1.9
R&S®NRV-Z6 PC 3.5; 50 Ω	50 MHz to 26.5 GHz	400 pW to 20 mW 100 mW (AVG) 100 mW (PK)	50 MHz to 4 GHz: 1.15 (0.7) >4 to 18 GHz: 1.37 (0.157) >18 to 26.5 GHz: 1.37 to 0.157)	200 pW	80 pW	0.04	0.06 0.07 to 0.15 0.08 to 0.09
R&S®NRV-Z15 K; 50 Ω	50 MHz to 40 GHz	400 pW to 20 mW 100 mW (AVG) 100 mW (PK)	50 MHz to 4 GHz: 1.15 (0.7) >4 to 18 GHz: 1.37 (0.157) >18 to 40 GHz: 1.37 to 0.157)	200 pW	80 pW	0.04	0.05 to 0.06 0.07 to 0.15 0.08 to 0.1
R&S®NRV-Z31 N; 50 Ω	30 MHz to 6 GHz 2 μs (mod. 02/03), 200 μs (mod. 04) 10 Hz (mod. 02) 100 Hz (mod. 03/04)	1 μW to 20 mW 100 mW (AVG) 100 mW (PK)	0.03 to 0.1 GHz: 1.05 (0.024) >0.1 to 2 GHz: 1.1 (0.048) >2 to 4 GHz: 1.2 (0.09) >4 to 6 GHz: 1.35 (0.15)	30 nW	3 nW	included in calibration uncertainty	0.06 0.07 0.11 to 0.15 0.12 to 0.16
R&S®NRV-Z32 N; 50 Ω	30 MHz to 6 GHz 2 μs (mod. 05), 200 μs (mod. 04) 25 Hz (mod. 05) 100 Hz (mod. 04)	100 μW to 2 W 1 W (AVG) 8 W (PK, 1 μs)	0.03 to 2 GHz: 1.11 (0.052) >2 to 4 GHz: 1.11 (0.052) >4 to 6 GHz: 1.22 (0.099)	3 μW	0.3 μW	included in calibration uncertainty	0.08 to 0.10 0.13 to 0.25 0.18 to 0.27
R&S®NRV-Z33 N; 50 Ω	30 MHz to 6 GHz 2 μs (mod. 03), 200 μs (mod. 04) 100 Hz (mod. 03/04)	1 mW to 20 W 12 W to 18 W (AVG) 80 W (PK)	0.03 to 2 GHz: 1.11 (0.052) >2 to 4 GHz: 1.22 (0.099) >4 to 6 GHz: 1.22 (0.099)	30 μW	3 μW	included in calibration uncertainty	0.08 to 0.10 0.15 to 0.18 0.18 to 0.20
R&S®NRV-Z51 N; 50 Ω	DC to 18 GHz	1 μW to 100 mW 300 mW (AVG) 10 W (PK, 1 μs)	DC to 2 GHz: 1.1 (0.048) >2 to 12.4 GHz: 1.15 (0.07) >12.4 to 18 GHz: 1.2 (0.09)	60 nW	22 nW	0.02	0.05 0.05 to 0.07 0.09 to 0.12
R&S®NRV-Z52 PC 3.5; 50 Ω	DC to 26.5 GHz	1 μW to 100 mW 300 mW (AVG) 10 W (PK, 1 μs)	DC to 2 GHz: 1.1 (0.048) >2 to 12.4 GHz: 1.15 (0.07) >12.4 to 18 GHz: 1.2 (0.09) >18 to 26.5 GHz: 1.25 (0.11)	60 nW	22 nW	0.02	0.05 to 0.06 0.06 to 0.08 0.10 to 0.13 0.08 to 0.09
R&S®NRV-Z53 N; 50 Ω	DC to 18 GHz	100 μW to 10 W 12 W to 18 W (AVG) 1 kW (PK, 1 μs)	0.05 to 2 GHz: 1.11 (0.052) >2 to 8 GHz: 1.22 (0.099) >8 to 12.4 GHz: 1.27 (0.119) >12.4 to 18 GHz: 1.37 (0.157)	6 μW	2.2 μW	0.03 + 0.01 P/W	0.07 0.10 0.12 to 0.13 0.14 to 0.18
R&S®NRV-Z54 N; 50 Ω	DC to 18 GHz	300 μW to 30 W 24 W to 36 W (AVG) 1 kW (PK, 3 μs)	0.05 to 2 GHz: 1.11 (0.052) >2 to 8 GHz: 1.22 (0.099) >8 to 12.4 GHz: 1.27 (0.119) >12.4 to 18 GHz: 1.37 (0.157)	20 μW	7 μW	0.03 + 0.007 P/W	0.08 0.10 to 0.11 0.12 to 0.13 0.14 to 0.18
R&S®NRV-Z55 K; 50 Ω	DC to 40 GHz	1 μW to 100 mW 300 mW (AVG) 10 W (PK, 1 μs)	DC to 2 GHz: 1.1 (0.048) >2 to 12.4 GHz: 1.15 (0.07) >12.4 to 18 GHz: 1.2 (0.08) >18 to 26.5 GHz: 1.25 (0.11) >26.5 to 40 GHz: 1.30 (0.13)	60 nW	22 nW	0.02	0.05 0.06 to 0.08 0.10 to 0.13 0.08 to 0.09 0.10 to 0.11



Contents Overview

Chapter Overview

Type Index

R&S Addresses





Contents Overview

Chapter Overview

Type Index

R&S Addresses



Power Sensors R&S®NRV-Z

Dimensions and weight	
R&S®NRV-Z1 to -Z15/-Z31/-Z51/-Z52	120 mm × 37 mm × 31 mm; 0.35 kg
R&S®NRV-Z32	190 mm × 37 mm × 31 mm; 0.42 kg
R&S®NRV-Z33/-Z53	240 mm × 54 mm × 60 mm; 0.53 kg
R&S®NRV-Z54	298 mm × 54 mm × 60 mm; 0.68 kg
Length of connecting cable	approx. 1.3 m; other lengths on request

Ordering information

Peak Power Sensors		
50 Ω, 6 GHz, 20 mW		
Standard model	R&S®NRV-Z31	0857.9604.02
High-speed model	R&S®NRV-Z31	0857.9604.03
TDMA model	R&S®NRV-Z31	0857.9604.04
50 Ω, 6 GHz, 2 W		
TDMA model	R&S®NRV-Z32	1031.6807.04
General-purpose model	R&S®NRV-Z32	1031.6807.05
50 Ω, 6 GHz, 20 W		
High-speed model	R&S®NRV-Z33	1031.6507.03
TDMA model	R&S®NRV-Z33	1031.6507.04
Power Sensors		
20 mW, 50 Ω, 18 GHz	R&S®NRV-Z1	0828.3018.02
500 mW, 50 Ω, 18 GHz	R&S®NRV-Z2	0828.3218.02
13 mW, 75 Ω, 2.5 GHz	R&S®NRV-Z3	0828.3418.02
20 mW, 50 Ω, 6 GHz	R&S®NRV-Z4	0828.3618.02
500 mW, 50 Ω, 6 GHz	R&S®NRV-Z5	0828.3818.02
20 mW, 50 Ω, 26.5 GHz	R&S®NRV-Z6	0828.5010.03
20 mW, 50 Ω, 40 GHz	R&S®NRV-Z15	1081.2305.02
100 mW, 50 Ω, 18 GHz	R&S®NRV-Z51	0857.9004.02
100 mW, 50 Ω, 26.5 GHz	R&S®NRV-Z52	0857.9204.02
10 W, 50 Ω, 18 GHz	R&S®NRV-Z53	0858.0500.02
30 W, 50 Ω, 18 GHz	R&S®NRV-Z54	0858.0800.02
100 mW, 50 Ω, 40 GHz	R&S®NRV-Z55	1081.2005.02

Measurement time in seconds (from trigger to output of first byte) depending on filter setting

Resolution	Filter number												
	0	1	2	3	4	5	6	7	8	9	10	11	12
R&S®NRV-Z1 to -Z15	0.045	0.05	0.06	0.08	0.15	0.27	0.49	0.95	1.85	3.6	7.2	14.5	28.5
R&S®NRV-Z31, mod. 02	1.04	1.04	1.05	1.07	1.13	1.24	1.44	1.84	2.7	4.3	7.5	14	27
R&S®NRV-Z31 to -Z33, mod. 03, 04	0.135	0.14	0.15	0.17	0.23	0.34	0.54	0.94	1.77	3.4	6.6	13	26
R&S®NRV-Z32, mod. 05	0.435	0.44	0.45	0.47	0.53	0.64	0.84	1.24	2.07	3.7	6.9	14	27
R&S®NRV-Z51 to -Z55	0.115	0.12	0.13	0.15	0.21	0.32	0.52	0.92	1.75	3.4	6.6	13	26
R&S®URV 5-Z2, -Z4, -Z7	0.065	0.07	0.08	0.1	0.2	0.38	0.72	1.45	2.8	5.5	11	22	44



Contents Overview

Chapter Overview

Type Index

R&S Addresses





Contents Overview

Chapter Overview

Type Index

R&S Addresses



Power Reflection Meter R&S®NRT

200 kHz to 4 GHz

0.3 mW to 2000 W

Power and reflection measurements under operational conditions

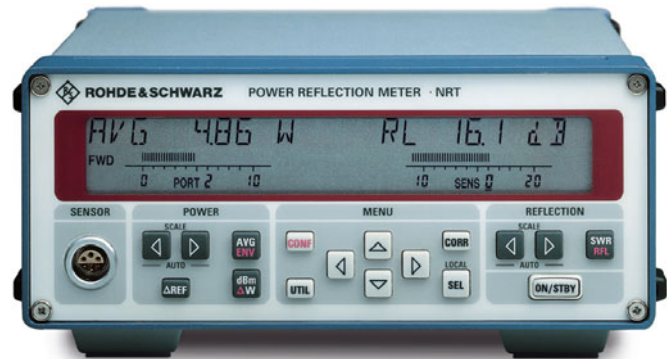

Brief description

Directional power meters are used to measure power and reflection under operational conditions. Typical applications are in installation, maintenance and monitoring of transmitters, antennas and RF generators in industrial and medical fields. Power Reflection Meter R&S®NRT is the right choice: rugged, accurate and compact. Due to the large variety of measurement functions and high accuracy it is suitable for classic applications in mobile use as well as for use in research, development, production and quality management.

Power Sensors R&S®NRT-Z43 and -Z44 for use in radiocommunications

The wide frequency range from 200 (400) MHz to 4 GHz covers all relevant frequency bands, the measurement method is compatible with all common analog and in particular digital modulation standards: GSM 900/1800/1900, DECT, PHS, NADC, PDC, DAB, DVB, IS-95-CDMA, WCDMA and many more.

Power Sensors R&S®NAP-Z

The complete range of power sensors of the predecessor model R&S®NAP is available for the customary frequency ranges, e.g. shortwave, and can be connected via an option. The sensors cover all the main frequency bands, from the maritime radio frequencies in the range of 200 kHz through to the digital GSM900 network.

The power measurement range extends from 0.3 mW to 2 kW. The R&S®NAP sensors are able to measure the average power irrespective of the modulation mode and some of them even the peak envelope power (PEP). All R&S®NAP sensors up to 1 GHz have a directivity of at least 30 dB and thus allow very precise reflection and power measurements.

Measurement directly on PC

The sensors of the R&S®NRT family are self-contained measuring instruments which are able to communicate with the basic unit or with a PC via a standard serial data interface. Interface Adapter R&S®NRT-Z3 allows connection to the serial RS-232-C standard interface of PCs (COMx), PC Card Interface Adapter R&S®NRT-Z4 operation at the PC card connector of laptops and notebooks. A program running under Windows (V-R&S®NRT) is available for operation of the sensor and display of the measurement results.



Direct power monitoring on PC

Operation, measurement functions

Thanks to menu control, a manageable number of keys and a large display, operation of the R&S®NRT is extremely easy. Switchover between the main functions is made at a keystroke:

- ◆ Choice between average power, average burst power, peak envelope power (PEP) and peak-to-average power ratio (crest factor)
- ◆ Switchover between forward power and absorbed power
- ◆ Measurement of power differences in dB or %
- ◆ Choice between return loss, SWR or reflection coefficient in reflection measurements
- ◆ Acoustic SWR monitoring
- ◆ Indication of maximum and minimum values
- ◆ Quasi-analog bargraph display
- ◆ Choice between measurement at the source or at the load



Contents Overview

Chapter Overview

Type Index

R&S Addresses



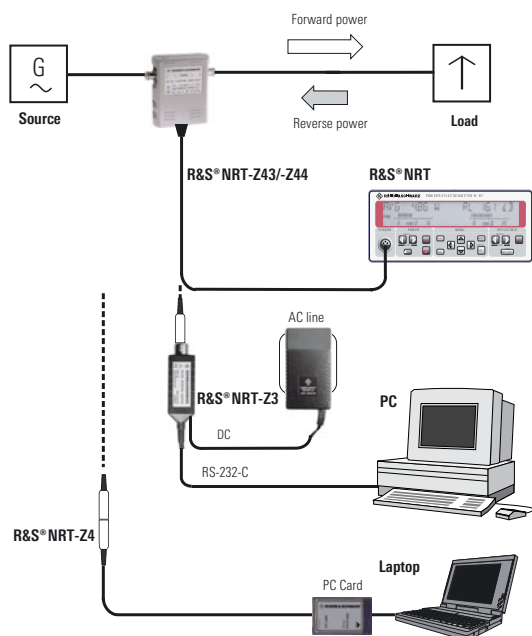

Power and reflection measurement with R&S® NRT-Z43/-Z44: readout of results either on basic unit or directly on PC

Options

The R&S® NRT basic unit comes with an IEC-bus (IEEE488) and RS-232-C interface, both to SCPI standard. Three options allow the R&S® NRT to be adapted to different applications:

- ◆ Test input for connection of NAP sensors
- ◆ Two additional test inputs for R&S® NRT sensors for simultaneous monitoring of up to three testpoints (R&S® NRT-B2)
- ◆ Battery and built-in charger for mobile use (R&S® NRT-B3)

Specifications in brief: power sensors

General data	R&S® NRT-Z43	R&S® NRT-Z44
Power measurement range ¹⁾	0.0007 W to 30 W (average)/75 W (peak)	0.003 W to 120 W (average)/300 W (peak)
Frequency range	400 MHz to 4 GHz	200 MHz to 4 GHz
SWR (referred to 50 Ω)	1.07 max. from 0.4 GHz to 3 GHz 1.12 max. from 3 GHz to 4 GHz	1.07 max. from 0.2 GHz to 3 GHz 1.12 max. from 3 GHz to 4 GHz
Insertion loss	0.06 dB max. from 0.4 GHz to 1.5 GHz 0.09 dB max. from 1.5 GHz to 4 GHz	0.06 dB max. from 0.2 GHz to 1.5 GHz 0.09 dB max. from 1.5 GHz to 4 GHz
Directivity	30 dB min. from 0.4 GHz to 3 GHz 26 dB min. from 3 GHz to 4 GHz	30 dB min. from 0.2 GHz to 3 GHz 26 dB min. from 3 GHz to 4 GHz
Average power measurement ²⁾		
Definition	mean value of carrier power, averaged over several modulation cycles (thermal equivalent, true rms value in case of voltage measurement)	
Power measurement range	0.007 W [0.0007] to 75 W (CW, FM, jM, FSK, GMSK or equivalent)	0.03 W [0.003] to 300 W (CW, FM, jM, FSK, GMSK or equivalent)
CF: peak-to-average power ratio (crest factor)	to 30 [3] W (CDMA, WCDMA, DAB, DVB) to 75 [7.5] W/CF (other modulation)	to 120 [12] W (CDMA, WCDMA, DAB, DVB) to 300 [30] W/CF (other modulation)
Modulation	for all kinds of analog and digital modulation; lowest frequency component of signal envelope should exceed 7 Hz for steady indication	
Measurement uncertainty at 18°C to 28°C	unmodulated RF (CW): 3.2% of rdg (0.14 dB)	unmodulated RF (CW): 3.2% of rdg (0.14 dB)
Burst average power measurement ²⁾		
Definition	average on-power of periodic carrier bursts, based on the measurement of average power under consideration of burst width t and repetition rate 1/T: burst average power = average power × T/t	
Power measurement range	$0.007 [0.0007] \text{ W} \times \frac{T}{t}$	$0.03 [0.003] \text{ W} \times \frac{T}{t}$
	up to specified upper limit of average power measurement	
Burst width (t)	0.2 μs to 150 ms	
Repetition rate (1/T)	7/s min.	
Measurement of peak-to-average power ratio (crest factor)		
Definition	ratio of peak envelope power to average power in dB (only with 1 → 2 forward direction)	
Power measurement range	see average power and peak envelope power specifications	
Measurement of peak envelope power (PEP)		
Definition	peak value of carrier power (only with 1 → 2 forward direction)	
Power measurement range	0.1 W (1)* to 75 W	0.4 W (4)* to 300 W
Burst signals (repetition rate min. 20/s)	(* lower measurement limit depending on modulation)	(* lower measurement limit depending on modulation)



Contents Overview

Chapter Overview

Type Index

R&S Addresses



Measurement of complementary cumulative distribution function (CCDF)	R&S®NRT-Z43		R&S®NRT-Z44			
Definition	probability in % of forward power envelope exceeding a given threshold (only with 1 → 2 forward direction)					
Measurement range	0% to 100%		0% to 100%			
Threshold level range	0.25 W to 75 W		1 W to 300 W			
Reflection measurement ²⁾ (values in {} : 3 GHz to 4 GHz)						
Definition	measurement of load match in terms of SWR, return loss or reflection coefficient					
Reflection measurement range	0 dB to 23 {20} dB / 1.15 {1.22} to ∞ / 0.07 {0.10} to 1					
Return loss/SWR/reflection coefficient						
Min. forward power	0.007 [0.07] W (specs met from 0.05 [0.5] W)		0.03 [0.3] W (specs met from 0.2 [2] W)			
General data						
	R&S®NAP-Z3	R&S®NAP-Z4	R&S®NAP-Z5	R&S®NAP-Z6	R&S®NAP-Z7	R&S®NAP-Z8
Power measurement range ¹⁾	0.01 W to 35 W	0.03 W to 110 W	0.1 W to 350 W	0.3 W to 1100 W	0.05 W to 200 W	0.5 W to 2000 W
Frequency range	25 MHz to 1 GHz	25 MHz to 1 GHz	25 MHz to 1 GHz	25 MHz to 1 GHz	0.4 MHz to 80 MHz	0.2 MHz to 80 MHz
SWR (referred to 50 Ω)	1.03 max.	1.03 max.	1.03 max.	1.05 max.	1.03 max. (1.02 max. from 1.5 MHz to 30 MHz)	
Insertion loss						
up to 0.3 GHz	0.10 dB max.	0.08 dB max.	0.08 dB max.	0.05 dB max.	–	–
up to 0.5 GHz	0.25 dB max.	0.15 dB max.	0.15 dB max.	0.10 dB max.	–	–
total frequency range	0.75 dB max.	0.35 dB max.	0.20 dB max.	0.15 dB max.	0.015 dB max.	0.015 dB max.
Directivity	30 dB min. (30 MHz to 1 GHz), 26 dB min. (25 MHz to 30 MHz)			35 dB min. (1.5 MHz to 30 MHz)		
Average power measurement						
Measurement range	0.01 W to 35 W	0.03 W to 110 W	0.1 W to 350 W	0.3 W to 1100 W	0.05 W to 200 W	0.5 W to 2000 W
Measurement uncertainty at 20°C to 25°C	6% of reading	6% of reading	6% of reading	6% of reading	6 [4] % of reading (1.5 MHz to 30 MHz) value in brackets: sensor-specific calibration factors taken into account	
Measurement of peak envelope power						
Measurement range	not possible	not possible	not possible	not possible	0.5 W to 200 W	5 W to 2000 W
AM					30 Hz to 10 kHz	30 Hz to 10 kHz
Burst width t					20 μs min.	20 μs min.
Repetition rate 1/T					30/s min.	30/s min.
Reflection measurement						
Measurement range for return loss/SWR/reflection coefficient	0 dB to 23 dB / 1.15 to ∞ / 0.07 to 1 (30 MHz to 1 GHz)				0 dB to 28 dB/1.08 to ∞/0.04 to 1 (1.5 to 30 MHz)	
Minimum forward power	0.1 (0.6) W	0.3 (2) W	1 (6) W	3 (20) W	0.5 (10) W	5 (100) W
	specs met with power values in ()					

General data	R&S®NAP-Z10 (model .02)	R&S®NAP-Z11 (model .02)
Power measurement range ¹⁾	0.005 W to 20 W	0.05 W to 200 W
Frequency range	35 MHz to 1 GHz	35 MHz to 1 GHz
SWR (referred to 50 Ω)	max. 1.03	max. 1.03
Insertion loss		
up to 0.3 GHz	0.10 dB max.	0.08 dB max.
up to 0.5 GHz	0.25 dB max.	0.15 dB max.
total frequency range	0.75 dB max.	0.20 dB max.
Directivity	30 dB min. from 40 MHz to 1 GHz 26 dB min. from 35 GHz to 40 GHz	
Average power measurement		
Measurement range	0.005 W to 20 W	0.05 W to 200 W
Measurement uncertainty at 20 to 25°C	6.5% of reading	6.5% of reading
Measurement of peak envelope power		
Measurement range	0.05 W to 20 W	0.5 W to 200 W
AM	50 Hz to 100 kHz	50 Hz to 100 kHz
Burst width t	min. 4,5 μs	min. 4,5 μs
Repetition rate 1/T	min. 50/s	min. 50/s
Reflection measurement		
Measurement range Return loss/SWR/Reflection coefficient	0 dB to 23 dB/1.15 to ∞/0.07 to 1 (40 MHz to 1 GHz)	
Minimum forward power	0.05 (0.35) W	0.5 (3.5) W
	specs met with power values in ()	
Measurement time	equal to measurement time of selected power measurement function, shortest with average power measurement	



Contents Overview

Chapter Overview

Type Index

R&S Addresses





Contents Overview

Chapter Overview

Type Index

R&S Addresses



Specifications in brief: R&S®NRT basic unit

You will find detailed and binding data on the enclosed CD (./DATASHEET/NRT.pdf), or, for the latest updates, visit www.rohde-schwarz.com, search term: NRT

Measurement functions	
Power	forward power and power absorbed by the load in W, dBm, dB or % (dB and % referred to measured value or reference value)
Power parameters ³⁾	average, burst average, envelope peak, peak-to-average ratio (crest factor) and complementary cumulative distribution function (CCDF)
Reflection	SWR, return loss, reflection coefficient, reverse forward power ratio and reverse power
Frequency response correction	upon input of RF frequency, the stored correction factors of the power sensor being taken into account; for NAP sensors the R&S®NRT basic unit offers memory for 3 sets of calibration factors
Digital	simultaneous indication of power, reflection and frequency
Resolution	HIGH: 4½ digits (0.001 dB) LOW: 3½ digits (0.01 dB)
Analog	two 50-element bargraphs for indication of power and reflection with selectable or predefined scale-end values
Averaging	automatic, depending on selected resolution and sensor characteristics
Max/Min.	indication of current maximum, minimum or maximum value for the selected measurement functions
Remote control	IEC/IEEE bus
Serial interface	9-pin sub-D connector to EIA-232E
General data	
Power supply	
AC supply	100 to 240 V, 50 Hz to 60 Hz or 100 to 120 V, 400 Hz; 35 VA, max. 0.4 A
Battery	with option R&S®NRT-B3, operating time approx. 8 h with one R&S®NRT-Z power sensor and option R&S®NRT-B1; recharging within 2 hours in quick-charge mode
Dimensions	219 mm × 103 mm × 240 mm
Weight	3.5 kg with all options
Power Sensors R&S®NRT-Z43/-Z44	
Measurement channels	2 (for forward and reverse power)
Forward dir. 1 → 2	standard for all measurement functions
Forward dir. 2 → 1	only for measurement of average and burst average power (at low levels)
Measurement functions	forward power and reflection
Power parameters	average, burst average, envelope peak, peak-to-average ratio and complementary cumulative distribution function (CCDF)
Reflection	return loss, SWR, reflection coefficient, reverse power
Range selection	automatic
Video bandwidth	4 kHz, 200 kHz and "FULL" available for all power parameters except average power measurement
Frequency response correction	upon input of RF frequency, the stored correction factors of both measurement channels being taken into account
RF connectors	N (female) on both ends
Remote control	via serial RS-422 interface, 6-pin LEMOSA connector

General data	
Power supply	6.5 to 28 V, approx. 1.5 W
Length of extension cable	max. 500 m with 12 V supply voltage (via R&S®NRT-Z3, R&S®NRT-Z4 or line-operated R&S®NRT) max. 30 m with 7 V supply voltage (battery-operated R&S®NRT)
Dimensions (W × H × D)	120 mm × 95 mm × 39 mm
Weight	0.65 kg
Power measurement with R&S®NAP power sensors and option R&S®NRT-B1	
Measurement channels	2 identical channels (for forward and reverse power)
Range selection	automatic
Frequency response correction	with NAP-Z7 and NAP-Z8 under consideration of calibration factors
Zero adjustment	with RF level switched off, duration approx. 5 s
RF connectors	N male/N female (NAP-Z6: 7/16 male, 7/16 female)
Length of connecting cable	1.5 m

Ordering information

Power Reflection Meter	R&S®NRT	1080.9506.02
Power Sensors R&S®NRT (incl. R&S®NRT software)		
30 (75) W, 0.4 GHz to 4 GHz	R&S®NRT-Z43	1081.2905.02
120 (300) W, 0.2 GHz to 4 GHz	R&S®NRT-Z44	1081.1309.02
Power Sensors R&S®NAP		
35 W, 25 MHz to 1000 MHz	R&S®NAP-Z3	0392.6610.55
110 W, 25 MHz to 1000 MHz	R&S®NAP-Z4	0392.6910.55
350 W, 25 MHz to 1000 MHz	R&S®NAP-Z5	0392.7116.55
1100 W, 25 MHz to 1000 MHz	R&S®NAP-Z6	0392.7316.56
200 W, 0.4 MHz to 80 MHz	R&S®NAP-Z7	0350.8214.02
2000 W, 0.2 MHz to 80 MHz	R&S®NAP-Z8	0350.4619.02
20 W, 35 MHz to 1000 MHz	R&S®NAP-Z10	0858.0000.02
200 W, 35 MHz to 1000 MHz	R&S®NAP-Z11	0852.6707.02
Options		
Interface for NAP-Z Power Sensors	R&S®NRT-B1	1081.0902.02
2 rear inputs for		
R&S®NRT-Z Power Sensors	R&S®NRT-B2	1081.0702.02
Battery supply with built-in charger and NiMH battery	R&S®NRT-B3	1081.0502.02
Recommended extras		
NiMH Battery	R&S®NRT-Z1	1081.1209.02
Extension Cable		
for R&S®NRT-Z Power Sensors 10 m	R&S®NRT-Z2	1081.2505.10
for R&S®NRT-Z Power Sensors 30 m	R&S®NRT-Z2	1081.2505.30
for R&S®NAP-Z Power Sensors 25 m	R&S®NAP-Z2	0392.5813.02
RS-232-C Interface Adapter for R&S®NRT-Z Power Sensors including AC Power Supply	R&S®NRT-Z3	1081.2705.02
PC Card Interface Adapter for R&S®NRT-Z Power Sensors	R&S®NRT-Z4	1120.5005.02
Carrying Bag with Straps and Pocket of Accessories	R&S®ZZT-222	1001.0500.00
19" Rack Adapter	R&S®ZZA-97	0827.4527.00

1) Dependent on measurement function.

2) Values in []: 2→1 forward direction (if different from 1→2 forward direction).

3) Sensor-dependent.



Contents Overview

Chapter Overview

Type Index

R&S Addresses





Contents Overview

Chapter Overview

Type Index

R&S Addresses



Directional Power Meter R&S®NAS

1 MHz to 1990 MHz

10 mW to 1200 W

Convenient and precise power and SWR measurements in the entire field of radiotelephony

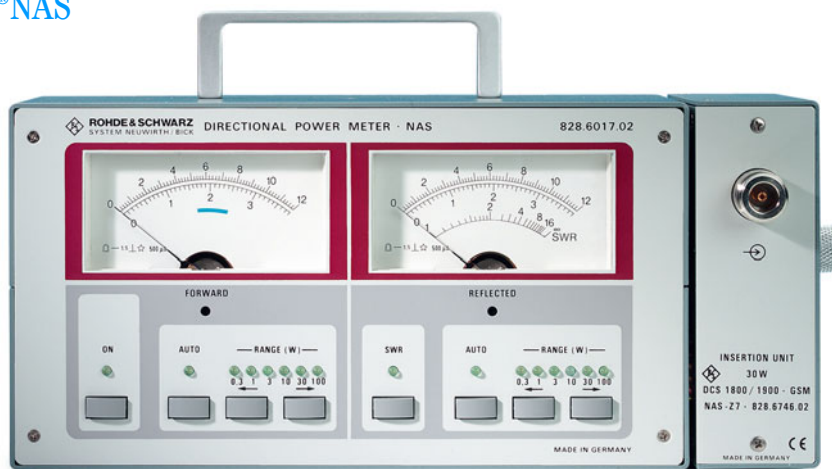

Brief description

Directional Power Meter R&S®NAS is the ideal servicing unit wherever power and SWR of all kinds of radio equipment have to be measured. Insertion units for mobile radio make the R&S®NAS a versatile unit and an investment for the future.

Main features

- ◆ Two moving-coil meters
- ◆ Autoranging
- ◆ Battery operation
- ◆ Automatic switchoff
- ◆ High EMI immunity
- ◆ Excellent price/performance ratio

Operation

Operation of the R&S®NAS is extremely simple and reliable thanks to microprocessor control. Forward and reflected power or forward power and SWR are simultaneously indicated on two large meters. Indication of SWR does away with the cumbersome use of tables.

Insertion units

Insertion units are either plugged to the side of the R&S®NAS or connected via a 1.5 m long cable for measurements at test points that are difficult to reach. Each insertion unit contains its individual calibration data which are read by the R&S®NAS and considered in the measurement results.

GSM 900/1800/1900 applications

Insertion Units R&S®NAS-Z6 and -Z7 measure the peak envelope power (PEP) of the clocked signal with due consideration of the timing laid down in the GSM specifications. Therefore the insertion units are ideal too for measurements on mobile stations which according to definition are sending signals in only one of the eight timeslots. Transient overshoots of the signal bursts are eliminated by a signal-controlled circuit so that the forward and reflected power as well as the SWR can be correctly measured and indicated.

Standard applications

The standard Insertion Unit R&S®NAS-Z5 with its wide frequency range is suitable for almost any application and practically covers all commercial analog RT services including air navigation.

Shortwave applications

Insertion Units R&S®NAS-Z1 and -Z2 have been especially designed for the frequency range up to 30 MHz.

R&S®NAS-Z2 is for powers up to 1200 W for use in long-range shortwave communication systems.

Terminated power measurements

For measurements on transmitters, a Termination R&S®NAZ 10 or R&S®NAZ 30 acting as a dummy antenna is connected to the output of the insertion unit.



Contents Overview

Chapter Overview

Type Index

R&S Addresses





Contents Overview

Chapter Overview

Type Index

R&S Addresses



Directional Power Meter R&S®NAS

Specifications in brief: Insertion Units R&S®NAS-Z

Model	R&S®NAS-Z1	R&S®NAS-Z2	R&S®NAS-Z3	R&S®NAS-Z5	R&S®NAS-Z6	R&S®NAS-Z7
Frequency range	1 MHz to 30 MHz	1 MHz to 30 MHz	25 MHz to 200 MHz	70 MHz to 1000 MHz	890 MHz to 960 MHz ¹⁾	890 MHz to 960 MHz ¹⁾ and 1710 to 1990 MHz
Power measurement range	0.01 W to 120 W	0.1 W to 1200 W	0.01 W to 120 W	0.01 W to 120 W	0.01 W to 120 W	0.01 W to 30 W ⁶⁾
Accuracy (of rdg)	±4.5%	±6.5%	±5.5%	±6.5% ²⁾	±5.5%	±6/8.5% (≤20 W) ⁵⁾ , ±7/9.5% (<30 W) ⁵⁾
SWR	<1.07	<1.07	<1.07	<1.07 ³⁾	<1.1	<1.15
Directivity	>30 dB	>30 dB	>30 dB	>30 dB ⁴⁾	>26 dB	>26 dB
Connector, characteristic impedance	N female, 50 Ω					
Dimensions (W × H × D); weight	55 mm × 120 mm × 90 mm; 0.7 kg					

1) Useful frequency range: 100 MHz to 1000 MHz for R&S®NAS-Z6, 850 MHz to 2000 MHz for R&S®NAS-Z7 (with wider error tolerances).

2) 100 MHz to 1000 MHz; 75 MHz to 100 MHz: -11 to +5.5% of reading; 70 to 75 MHz: -15 to -5.5% of reading.

3) f < 500 MHz; at f ≥ 500 MHz: < 1.1.

4) f < 500 MHz; at f ≥ 500 MHz: > 26 dB.

5) Wider error tolerances are valid within a frequency range of 1880 MHz to 1990 MHz.

6) Up to 100 W with wider error tolerances.

Specifications in brief: basic unit

Display	two moving-coil meters for forward and reflected power, plus SWR indication
Range selection	automatic or manual, separate for forward and reflected power
Accuracy (18°C to 28°C)	±1.5% of selected range + error of power sensor
Additional uncertainty at temperatures >28°C and <18°C	≤0.25% of rdg/°C
Automatic switchoff	approx. 1 h after last keystroke
General data	
Power supply	5 dry batteries IEC R20, service life >150 h (alkaline-manganese batteries)
Dimensions (W × H × D); weight	210 mm × 145 mm × 90 mm; 2 kg

Ordering information

Directional Power Meter	R&S®NAS	0828.6017.02
Insertion Unit	R&S®NAS-Z1	0828.6317.02
	R&S®NAS-Z2	0828.6417.02
	R&S®NAS-Z3	0828.6517.02
	R&S®NAS-Z5	0828.6717.03
for GSM900	R&S®NAS-Z6	0828.6723.02
for GSM 900/1800/1900	R&S®NAS-Z7	0828.6746.02
Recommended extras		
Connecting Cable (1.5 m) for detached operation of insertion units	R&S®NAS-Z9	0828.6969.02
Carrying Bag	R&S®NAS-Z10	0828.6917.02

Termination	R&S®NAZ10	R&S®NAZ30
Power-handling capacity (for 1 min)	10 W (15 W)	30 W (50 W)
Frequency range	0 Hz to 2 GHz	0 Hz to 4 GHz
VSWR	≤1.15	≤1.1 to 2 GHz
Connector, impedance	N male, 50 Ω	N male, 50 Ω
Order number	1029.2408.02	1029.2508.02



Contents Overview

Chapter Overview

Type Index

R&S Addresses





Contents Overview

Chapter Overview

Type Index

R&S Addresses



Level Meter R&S®URV35

DC to 3/40 GHz

200 μ V to 1000 V; 100 pW to 30 W

Power and voltage measurement with
a unique analog/digital display

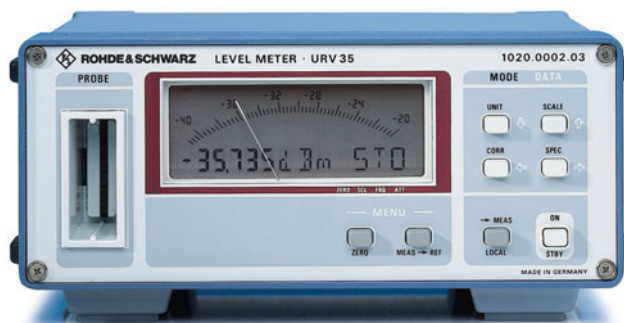

Brief description

R&S®URV35 is a voltmeter and power meter for versatile applications in service and production as well as for precision measurements in RF and microwave labs. A large variety of probes and sensors allows voltage measurements up to 3 GHz and power measurements up to 40 GHz.

Main features

- ◆ Compact, handy and mobile
- ◆ Voltmeter and power meter in one unit
- ◆ Rugged design
- ◆ Combined (true) analog and digital display
- ◆ Menu-guided operation
- ◆ AC-supply or battery operation
- ◆ Large choice of probes and sensors
- ◆ DC frequency input for tracking frequency-response correction
- ◆ Analog output for YT recorder
- ◆ RS-232-C interface
- ◆ Test generator for checking the probe or sensor (optional)

Specifications in brief,
voltage probes page 311, power sensors page 298

You will find detailed and binding data on the enclosed CD (./DATASHEET/URV35.pdf), or, for the latest updates, visit www.rohde-schwarz.com, search term: URV35

Probes and sensors	all R&S®URV5 probes and R&S®NRV sensors
Display	backlight LCD, moving-coil meter with short response time
Absolute readout	dBm, dB μ V, V or W
Relative readout	dB, referred to stored reference value
Resolution of digital display	4½ digits: 19999 steps; 0.001 dB 3½ digits: 1999 steps; 0.01 dB
Analog display	steps of 1-2.5-5 for V, W and dB, 5 (10) dB for dBm and dB μ V with windows of 10 (20) dB
Entry of scaling	left- and right-hand scale limits
Display filtering	level-dependent digital averaging filter
Accuracy (18°C to 28°C)	
Digital display	± 0.02 dB ± 1 digit
Moving-coil meter	1.5% of full scale
Zero adjustment	via interface or manually, approx. 4 s
Hold function	for displayed measurement result
Measurement rate	5 readouts/s in manual mode
Frequency-response correction (selectable)	sensor-specific calibration data taken into account
Attenuation compensation (selectable)	external attenuation or gain taken into account, range ± 199.99 dB
Entry of reference value	measured value on keystroke, or value entered via interface or keypad
Reference impedance	50 Ω /75 Ω , automatic/selectable
Interfaces	
Remote control	serial interface (V.24, RS-232-C)
DC frequency input	BNC, $R_{in} = 9$ M Ω
Input voltage range	± 12 V, linear with selectable scale

DC voltage output	BNC, $R_{out} = 1$ k Ω , EMF proportional to pointer deflection
Left-/right-hand scale limit	corresponding to 0/+3 V
Additional settling time	250 ms
Accuracy	± 5 mV

General data

Model .02 power supply	
Battery, standard	5 \times 1.5 V alkaline-manganese LR20
Operating time	125 h
Rechargeable battery, retrofittable	5 \times 1.2 V NiCd IEC KR35/62
Operating/charging time	60 h/24 h
AC supply with	
R&S®UZ-35, European version	230 V $\pm 10\%$, 47 to 63 Hz
R&S®UZ-35, US version	120 V $\pm 10\%$, 57 to 63 Hz
Model .03 (AC supply)	115 V $\pm 15\%$ / -22% , 47 to 440 Hz 230 V $\pm 15\%$ / -22% , 47 to 63 Hz (switch-selectable); 6 VA
Dimensions (W \times H \times D)	220 mm \times 100 mm \times 240 mm
Weight model .02	3.1 kg/2.3 kg with/without batteries
Weight model .03	2.4 kg

Ordering information

Level Meter

battery-operated	R&S®URV35	1020.0002.02
AC-supply model	R&S®URV35	1020.0002.03
Options		
Sensor Check Source	R&S®NRVS-B1	1029.2908.02
Power Supply/Charger (for model .02) ¹⁾	R&S®UZ-35	1020.1709.02
Power Supply/Charger (for model .02) ²⁾	R&S®UZ-35	1020.1709.04
Service Kit	R&S®URV35-S1	1029.2608.02

1) European power supply.

2) US power supply.



Contents Overview

Chapter Overview

Type Index

R&S Addresses



Millivoltmeter R&S®URV5

DC, 9 kHz to 3/26.5 GHz

200 μ V to 1000 V

Voltage, level, power measurements; trend indication



Brief description

Millivoltmeter R&S®URV5 is a broadband voltage, level and power meter of high accuracy and sensitivity. It is suitable both for manual operation and for use in systems. A wide choice of individually calibrated probes and sensors allows R&S®URV5 to be used for a great variety of measurements:

- ◆ With RF probe and DC probe for no-load AC and DC voltage measurements
- ◆ Voltage (and power) measurements in coaxial 50 Ω and 75 Ω systems using low-reflection and low-loss insertion units
- ◆ Power measurements up to 26.5 GHz using Power Sensors R&S®NRV-Z1 to -Z6

Main features

- ◆ Two test inputs
- ◆ High accuracy through μ P-controlled error correction: $\pm 1\%$
- ◆ Dynamic range >94 dB
- ◆ IEC/IEEE-bus interface
- ◆ Readout in all standard units with selectable reference impedance; relative measurements
- ◆ Optional DC output
- ◆ PEP measurement

Specifications in brief, voltage probes page 311, power sensors page 298

You will find detailed and binding data on the enclosed CD (./DATASHEET/URV5.pdf), or, for the latest updates, visit www.rohde-schwarz.com, search term: URV5

Probes and sensors	all R&S®URV5 probes and R&S®NRV sensors, except R&S®NRV-Z3x and R&S®NRV-Z5x, -Z15					
Test channels	2 (A and B)					
Absolute measurement	A, B					
Relative measurement	A/REF _A , B/REF _B , A/B, B/A					
Absolute readout	V, W, dBm, dBV					
Relative readout	Δ V, Δ W, Δ %, Δ dB, X/REF					
Resolution	0.01% or 0.01 dB					
Accuracy of voltage readout in V (18°C to 28°C)	$\pm 0.15\%$ of rdg per channel					
Filter	to reduce display noise in 6 steps (F0 to F5), selectable					
Zero adjustment	via keyboard or remote control					
Measurement rate (manual)	approx. 1 measurement/s with filter F0, up to 30 measurements/s with filter F5					
Measurement time (IEC/IEEE bus)	approx. 0.05 s with filter F5, up to 20 s with filter F0					
PEP measurement						
Pulse width	approx. 200 μ s to CW					
Min. pulse repetition frequency						
Filter	F0	F1	F2	F3	F4	F5
f_{\min} /Hz	0.05	0.25	1	5	25	100

Frequency-response correction (selectable)	sensor-specific frequency response after entry of test frequency
Attenuation compensation (selectable)	one attenuation value per channel can be entered (-199.99 dB to $+199.99$ dB)
Reference value for relative measurements	one value per channel

Optional DC Output R&S®URV5-B2

Output voltage range (EMKF)	-1.999 V to $+1.999$ V, $R_{\text{out}} = 1$ k Ω
Resolution; error	1 mV (10 digit); ± 2 mV

General data

Remote control	IEC625-1 (IEEE 488) for control of all instrument functions
Power supply	100/120/220/240 V $\pm 10\%$, 47 Hz to 63 Hz, 400 Hz, 30 VA
Dimensions (W \times H \times D)	241 mm \times 110 mm \times 340 mm
Weight	4.4 kg

Ordering information

Millivoltmeter	R&S®URV5	0394.8010.02
Options		
DC Output	R&S®URV5-B2	0079.0631.00
Service Kit for Calibration	R&S®UZ-8	0394.9968.02



Contents Overview

Chapter Overview

Type Index

R&S Addresses



Millivoltmeter R&S®URV55

DC to 3/40 GHz

200 μ V to 1000 V

100 pW to 30 W

RF/DC voltage, level and power

measurements



Brief description

Millivoltmeter R&S®URV55 is suitable for voltage measurements up to 3 GHz as well as for power and level measurements up to 40 GHz. Thanks to probes with calibration data memory and temperature sensors, which make adjustments by the user superfluous, R&S®URV55 provides at all times high-precision measurements free of operator's errors.

Main features

- ◆ Voltage, level and power measurements
- ◆ Large choice of intelligent probes and sensors (R&S®URV5-Z, R&S®NRV-Z)
- ◆ IEC/IEEE-bus interface
- ◆ DC frequency input for tracking frequency-response correction
- ◆ Analog output for YT recorder
- ◆ Storage of 20 complete instrument setups
- ◆ 13 digital filters for noise suppression, automatic or manual filter selection
- ◆ Sensor check source (optional)

Measuring heads

The range of measuring heads includes high-impedance probes with plug-on dividers and adapters (R&S®URV5-Z7, -Z1) as well as insertion units for voltage measurements on coaxial lines (R&S®URV5-Z2, -Z4). All power sensors of the R&S®NRV-Z series can be used without any restrictions.

Measurement time in seconds (from trigger to output of first byte) depending on filter setting

Resolution	Filter number												
	0	1	2	3	4	5	6	7	8	9	10	11	12
R&S®NRV-Z1 to -Z15	0.045	0.05	0.06	0.08	0.15	0.27	0.49	0.95	1.85	3.6	7.2	14.5	28.5
R&S®NRV-Z31, mod. 02	1.04	1.04	1.05	1.07	1.13	1.24	1.44	1.84	2.7	4.3	7.5	14	27
R&S®NRV-Z31 to -Z33, mod. 03, 04	0.135	0.14	0.15	0.17	0.23	0.34	0.54	0.94	1.77	3.4	6.6	13	26
R&S®NRV-Z32, mod. 05	0.435	0.44	0.45	0.47	0.53	0.64	0.84	1.24	2.07	3.7	6.9	14	27
R&S®NRV-Z51 to -Z55	0.115	0.12	0.13	0.15	0.21	0.32	0.52	0.92	1.75	3.4	6.6	13	26
R&S®URV 5-Z2, -Z4, -Z7	0.065	0.07	0.08	0.1	0.2	0.38	0.72	1.45	2.8	5.5	11	22	44



Contents Overview

Chapter Overview

Type Index

R&S Addresses





Contents Overview

Chapter Overview

Type Index

R&S Addresses



Millivoltmeter R&S®URV55

Specifications in brief,
voltage probes page 311, power sensors page 298

You will find detailed and binding data on the enclosed CD
(../DATASHEET/URV55.pdf), or, for the latest updates, visit
www.rohde-schwarz.com, search term: URV55

Measurement functions	average power, pulse power, peak envelope power, AM, reflection, DC voltage (depending on sensor)
Frequency and level range	DC to 40 GHz, 100 pW to 30 W 9 kHz to 3 GHz, 200 mV to 1000 V (depending on sensor)
Probes and sensors	all R&S®NRV sensors and R&S®URV5 probes
Display	LCD for digits, units, menu-guided operation and analog display, adjustable backlighting
Display of results	single-channel (with optional display of correction frequency) or dualchannel
Absolute readout	W, dBm, V, dBmV
Relative readout	dB, %W or %V relative to a stored reference value
Analog display	automatic or with selectable scale
Digital display and resolution	max. 4½ digits, resolution selectable (0.1/0.01/0.001 dB)
Display filtering	averaging over 1 to 512 readings to reduce display noise; manual or automatic setting depending on measurement range and resolution
Display noise	see sensors from page 311/298
Measurement rate	see table on previous page
Accuracy (without sensor)	
18°C to 28°C	±0.02 dB ±1 digit
10°C to 40°C	±0.04 dB ±1 digit
0°C to 50°C	±0.06 dB ±1 digit
Zero adjustment	manual or via IEC/IEEE bus, duration approx. 4 s
Frequency response correction	sensor-specific calibration data taken into account; numerical entry of test frequency (keyboard or via IEC/IEEE bus) or by frequency-proportional DC voltage

Attenuation compensation	external attenuation or gain taken into account; data entry via keyboard or IEC/IEEE bus, range ±200 dB
Entry of reference value	measured value on keystroke or numerical entry via keypad or IEC/IEEE bus
Reference impedance	for conversion between voltage and power, automatic readout of reference impedance from sensor data memory or numerical entry via keyboard or IEC/IEEE bus (for RF probe)
Remote control	IEC625 (IEEE488), control of all instrument functions
DC frequency input	
Connector	BNC
Input voltage range	±12 V, linear with selectable scale
DC output	
Connector	BNC, R _{out} = 1 kΩ, EMF proportional to analog display
Left-/right-hand full-scale value	corresponding to 0/+3 V
Accuracy	±5 mV
Channels	1, 2
Sensor check source	option R&S®NRVS-B1
Output power	1 mW ±0.7%
Frequency	50 MHz
VSWR	1.05
RF connector	N female
General data	
Power supply	115 V +15/–22% (–15%) 47 Hz to 63 (440) Hz 230 V +15/–22%, 47 Hz to 63 Hz, 13 VA
Dimensions (W × H × D)	219 mm × 103 mm × 350 mm
Weight	3.2 kg

Ordering information

Millivoltmeter	R&S®URV55	1029.1701.02
Option		
Sensor Check Source	R&S®NRVS-B1	1029.2908.02
Recommended extras		
Rack adapter	R&S®ZZA-97	827.4527.00
Transit case for R&S®URV55, sensors and accessories	R&S®UZ-24	1029.3379.02
Service Kit	R&S®NRVS-S1	1029.2708.02



Contents Overview

Chapter Overview

Type Index

R&S Addresses





Contents Overview

Chapter Overview

Type Index

R&S Addresses



Probes and Insertion Units R&S®URV5-Z1/Z2/Z4/Z7/Z9 for voltage and level measurement



RF Probe R&S®URV5-Z7



DC Probe R&S®URV5-Z1

Brief description

R&S®URV5-Z probes and insertion units are indispensable tools for RF and microwave labs, test departments and service. They cover the frequency range from 9 kHz to 3 GHz and thus fill the gap between low-frequency voltage measurement at one end and microwave power measurement at the other end.

All corrections of the rectifier such as linearization, temperature compensation or frequency-response correction are made numerically. Each probe or insertion unit has a built-in calibration data memory with its individual data which are continuously read by the meter.

All AC probes read out the RMS value for unmodulated sinewave voltages.

RF Probe R&S®URV5-Z7

A versatile tool for measuring high-frequency voltages. Thanks to its low input capacitance of 2.5 pF ideal for practically no-load measurements on non-coaxial circuits up to about 500 MHz (with accessories up to 1 GHz). Measurement range with plug-on dividers 1000 V (input capacitance 0.5 pF).

Accessory Set R&S®URV-Z6

- ◆ Plug-on divider 20 dB and 40 dB for extending the measurement range and reducing the input capacitance to 100 V/1 pF or 1000 V/0.5 pF
- ◆ BNC adapter for level measurements on coaxial 50 Ω lines (see also Insertion Units R&S®URV5-Z2, -Z4)

Adapters R&S®URV-Z50 (50 Ω)

With integrated termination for power measurements on matched sources.

DC Probe R&S®URV5-Z1

Due to its low input capacitance ideal for DC voltage measurements on high-frequency modules.

Insertion Units R&S®URV5-Z2 (50 Ω), R&S®URV5-Z4 (50 Ω)

Insertion units are used for non-interrupting level measurements between source and load and for power measurements with wide dynamic range. They are made up of a short, reflection-free and low-loss line section with voltage tap and rectifier in the middle of the line.

With a well-matched load, the transmitted power P can be calculated for the measured voltage V_{rms} and the characteristic impedance Z_0 according to the formula $P = V_{\text{rms}}^2 / Z_0$.



Contents Overview

Chapter Overview

Type Index

R&S Addresses



Specifications in brief

The indicated measurement uncertainties are valid in the temperature range 18°C to 28°C. Influences of the basic unit, meter noise, zero error, mismatch and temperature effects (beyond the indicated range) must also be taken into account.

Model	Frequency range Impedance	Voltage measurement range	Power measurement range	Max. VSWR (reflection coefficient)		Measurement uncertainty in dB (% of voltage)		RF connector
		Max. load	Level meas. range					
RF Probe R&S®URV5-Z7	20 kHz to 500 MHz 2.5 pF/80 kΩ	200 μV to 10 V 15 V (RMS) 22 V (PK) 400 V (DC)	1 nW to 2 W -60/+33 dBm	-	-	0.07 to 1.1	(0.8 to 12)	BNC female/ female ¹⁾
with 20 dB divider (R&S®URV-Z6)	1 to 500 MHz 1 pF/1 MΩ	2 mV to 100 V 150 V (RMS) 220 V (PK) 1000 V (DC)	100 nW to 20 W -40/+43 dBm	-	-	1.1 to 1.9	(12 to 20)	BNC female/ female ¹⁾
with 40 dB divider (R&S®URV-Z6)	0.5 to 500 MHz 0.5 pF/10 MΩ	20 mV to 1000 V 1050 V (RMS) 1500 V (PK) 1000 V (DC)	10 μW to 20 W -20/+43 dBm	-	-	0.63 to 1.9	(7.3 to 20)	BNC female/ female ¹⁾
with 50-Ω Adapter R&S®URV-Z50	20 kHz to 1 GHz 50 Ω	200 μV to 10 V 10 V (RMS) 22 V (PK)	1 nW to 2 W -60/+33 dBm	20 to 50 kHz >0.05 to 50 MHz >50 to 100 MHz >100 to 500 MHz >500 to 700 MHz >0.7 to 1 GHz	1.03 (0.015) 1.03 (0.015) 1.06 (0.030) 1.11 (0.050) 1.22 (0.10) 1.44 (0.18)	0.90 0.12 to 0.20 0.20 0.30 to 0.63 1.0 to 1.4 1.0 to 1.4	(10) (1.3 to 2.3) (2.3) (3.3 to 7.3) (11 to 18) (11 to 18)	BNC female (male)
DC Probe R&S®URV5-Z1	3 pF/9 MΩ	1 mV to 100 V 400 V (PK)	-	-	-	0.013 dB 0.030 dB	(0.15%) ²⁾ (0.35%) ³⁾	BNC male
10 V Insertion Unit R&S®URV5-Z2	9 kHz to 3 GHz 50 Ω	200 μV to 10 V 15 V (RMS) 22 V (PK) 50 V (DC)	1 nW to 2 W -60/+33 dBm	9 kHz to 20 kHz >20 kHz to 50 kHz >50 kHz to 200 MHz >200 MHz to 500 MHz >500 MHz to 1 GHz >1.0 GHz to 2.0 GHz >2.0 GHz to 3.0 GHz	1.04 (0.02) 1.04 (0.02) 1.04 (0.02) 1.10 (0.048) 1.22 (0.10) 1.35 (0.15) 1.35 (0.15)	0.20 to 0.35 0.17 to 0.20 0.13 to 0.17 0.20 to 0.25 0.25 to 0.30 0.30 to 0.50 0.40 to 0.75	(2.3 to 4) (2.0 to 2.3) (1.5 to 2.0) (2.3 to 2.8) (2.8 to 3.4) (3.4 to 5.6) (4.5 to 8.3)	N female/male
100 V Insertion Unit R&S®URV5-Z4	100 kHz to 3 GHz 50 Ω	2 mV to 100 V 150 V (RMS) 220 V (PK) 1000 V (DC)	100 nW to 200 W -40/+53 dBm	100 kHz to 200 kHz >200 kHz to 500 kHz >0.5 MHz to 3 MHz >3 MHz to 200 MHz >200 MHz to 500 MHz >0.5 GHz to 1 GHz >1 GHz to 2 GHz >2 GHz to 3 GHz	1.04 (0.02) 1.04 (0.02) 1.04 (0.02) 1.04 (0.02) 1.04 (0.02) 1.07 (0.035) 1.07 (0.035) 1.10 (0.048)	0.50 to 1.50 0.25 to 0.60 0.13 to 0.20 0.13 0.17 to 0.20 0.20 to 0.25 0.30 to 0.50 0.45 to 1.05	(5.6 to 16) (2.8 to 6.7) (1.5 to 2.3) (1.5) (2.0 to 2.3) (2.3 to 2.8) (3.4 to 5.6) (5.0 to 11.4)	N female/male

Ordering information

DC Probe with ground cable, clip tip and BNC adapter	R&S®URV5-Z1	0395.0512.02
10 V Insertion Unit (50 Ω, 3 GHz)	R&S®URV5-Z2	0395.1019.02
100-V Insertion Unit (50 Ω, 3 GHz)	R&S®URV5-Z4	0395.1619.02
RF Probe with case, ground cable, ground sleeve and tape, hook and sol- der tip	R&S®URV5-Z7	0395.2615.02
Accessory Set for RF Probe Plug-on divider 20 dB and 40 dB, BNC adapter 50 Ω, reducing sleeve for divid- er, ground sleeves and ground tape	R&S®URV-Z6	0292.5364.02
50 Ω Terminating Adapter BNC female connector, with adapter to BNC male	R&S®URV-Z50	0394.9816.50

1) With BNC adapter (R&S®URV-Z6); maximum power is limited by power loss of the adapter.

2) 1 mV to 100 V.

3) 100 V to 400 V.

RMS Voltmeter R&S®URE2, RMS/Peak Voltmeter R&S®URE3

R&S®URE2: DC, 10 Hz to 25 MHz

R&S®URE3: DC, 20 mHz to 30 MHz

R&S®URE2 and R&S®URE3:

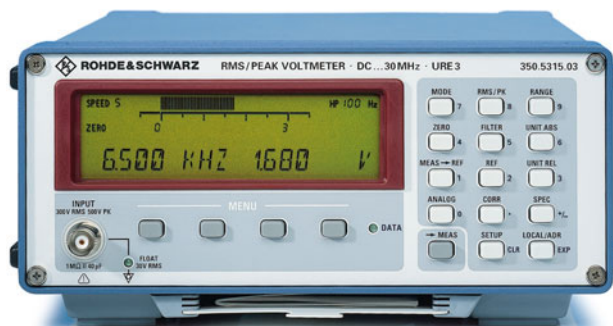
50 μ V to 300 V (AC); 0 V to 300 V (DC)RMS/Peak Voltmeter
R&S®URE3

Brief description

R&S®URE2 is a broadband RMS voltmeter featuring extremely high accuracy and speed. A patented rectifier circuit allows measurement of signals with a crest factor of up to 7 and frequencies of up to 25 MHz. RMS/Peak Voltmeter R&S®URE3 further enhances the range of applications due to its greater frequency range and higher accuracy, built-in frequency counter and additional peak-responding rectifier.

Fields of application

- ◆ Level measurements in audio range
- ◆ Interference measurements on switch-mode power supplies
- ◆ Measurement of extremely fast dialing signals and detection of simultaneously transmitted supply voltages in radiotelephony
- ◆ Automatic quality control of audio and video tapes
- ◆ High-frequency measurements in digital magnetic storage and optical data storage
- ◆ Peak weighting in video measurements (sync signals)
- ◆ Secondary calibration standard

Main features

- ◆ True RMS weighting for AC and AC + DC
- ◆ More than 30 measurements/s
- ◆ 4½-digit display and analog display with selectable scale
- ◆ Very high measurement accuracy
- ◆ Highpass and lowpass filters
- ◆ Relative measurement, max./min.
- ◆ Convenient menu-guided operation
- ◆ Use of commercial probes, taking into account their division factor in the displayed result
- ◆ IEC bus (IEEE488)

Additional features of R&S®URE3

- ◆ Peak-value measurement (positive, negative, peak-to-peak) without tilts and overshoots
- ◆ Fast RMS measurement even of very low-frequency signals
- ◆ Frequency measurement up to 30 MHz
- ◆ Ultrahigh measurement accuracy through automatic frequency response correction
- ◆ In/out option: dual-channel analog output, ready output, trigger input, TTL frequency counter input

Characteristics

Measurement accuracy

A patented rectifier circuit with microprocessor-controlled autocalibration makes for the outstanding measurement characteristics of R&S®URE2 and R&S®URE3. In order to further enhance the accuracy, correction factors are determined for each instrument and measurement range and stored in a nonvolatile memory.

A zero function allows noise voltages and the inherent noise to be compensated for, the measurement accuracy being thus increased in particular at low levels.

The measured frequency value is used by R&S®URE3 for an internal frequency response correction. This method increases the accuracy mainly at the higher frequencies. Distortion-free measurement of signals is ensured by:

- ◆ high input impedance
- ◆ low input capacitance
- ◆ highpass and lowpass filters that can be switched in to suppress hum or high-frequency noise voltages



Contents Overview

Chapter Overview

Type Index

R&S Addresses



Specifications in brief

RMS Voltmeter R&S®URE2

Measurement functions	RMS value, DC voltage
Range selection	automatic or manual
Input/impedance	BNC connector, floating/1 MΩ 40 pF
Display	LCD, 4½-digit readout, digital and analog in V, W, dBV, dBm, dBμV or dBu; difference, deviation in % or dB and ratio to a reference value
Remote control	to IEC625-2
RMS measurement	
Voltage measurement range	50 mV to 300 V
Ranges	1 mV to 300 V, 10 dB steps
Maximum reading	3800 or 12000 counts
Frequency range AC coupling	10 Hz to 25 MHz
Frequency range AC + DC	DC, 10 Hz to 25 MHz
Selectable lowpass filters	20 kHz, 100 kHz Butterworth (3 dB cutoff freq., 40 dB/decade)
Selectable highpass filters	10 Hz, 100 Hz, 1 kHz (lower meas. limit, AC component in AC + DC)
Time of triggered measurement	32 ms to 1.3 s (selectable; shortest meas. time with 1 kHz highpass only)
Maximum crest factor (S)	7 for nominal range
Measurement uncertainty for non-sinusoidal voltages (spectral components up to 25 MHz)	S <5: <1%, S <7: <3% (for S <3: included in basic error)
DC voltage measurement	general data same as R&S®URE3
DC voltage measurement	see R&S®URE3
General data	see R&S®URE3

RMS/Peak Voltmeter R&S®URE3

Measurement functions	RMS/peak value, DC voltage, frequency
Range selection	automatic or manual
Input	BNC connector, either floating or grounded, switch-selectable
Input impedance	1 MΩ 40 pF
Display	backlit LCD, 4½-digit level and 5-digit frequency indication, digital and analog in V, W, dBV, dBm, dBmV, dBu or Hz; difference, deviation in % or dB and ratio to a reference value
In/out option	two simultaneous analog outputs (level and frequency), frequency input, trigger input, ready output
Remote control	IEC625-2 (IEEE488.2)
RMS measurement	
Voltage measurement range	50 mV to 300 V
Ranges	1 mV to 300 V, 10 dB steps
Maximum reading	3800 or 12000 counts
Frequency range AC coupling	0.02/10/100/1000 Hz to 30 MHz
Frequency range AC + DC	same as AC coupling, plus DC compon.
Selectable lowpass filters	same as R&S®URE2, plus 1 MHz Bessel
Selectable highpass filters	same as R&S®URE2
Time of triggered measurement	32 ms to 60 s (selectable; shortest meas. time with 1 kHz highpass only)
Maximum crest factor (S)	7 for nominal range
Measurement uncertainty for non-sinusoidal voltages	same as R&S®URE2
Peak measurement	
Voltage measurement range	0.1 mV to 500 V
Ranges and resolution	3 mV to 1000 V, 10 dB steps
Maximum reading	1200 or 3800 counts
Frequency range AC coupling	10/100/1000 Hz to 10 MHz
Frequency range AC + DC	DC, 0.02 Hz to 10 MHz

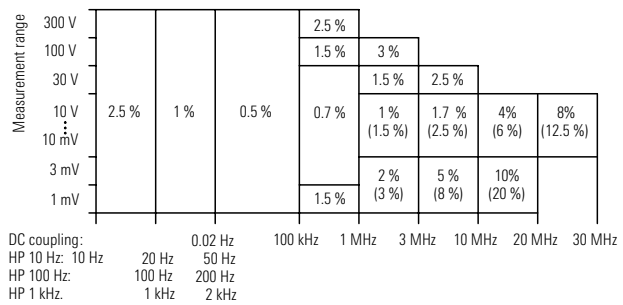

Accuracy of RMS measurement ($T_{amb} = 23 \pm 5^\circ\text{C}$), plus 10 counts for DC coupling (inherent noise taken into account by zero functions); values in parentheses without frequency response correction (R&S®URE3 only)

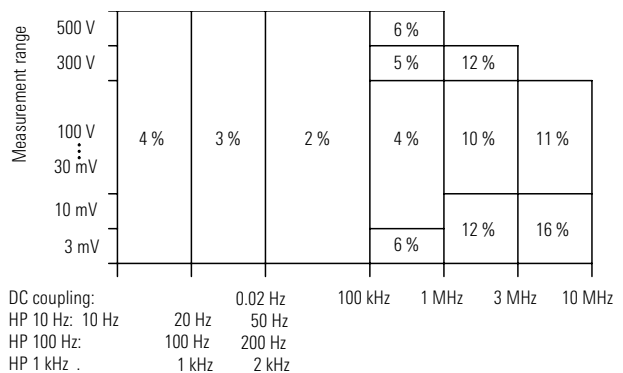

Accuracy of peak measurement ($T_{amb} = 23 \pm 5^\circ\text{C}$), sinewave signal, R&S®URE3 only)

Selectable highpass/lowpass filters	same as RMS measurement
Time of triggered measurement	65 ms to 60 s (selectable; shortest measurement time with 1 kHz highpass or DC coupling only)
Frequency measurement	
Frequency range	0.02 Hz to 30 MHz
Display	5 digits
Time of triggered measurement	75 ms to 60 s (selectable)
Sensitivity	min. 10 dB below nominal range
DC voltage measurement	
Voltage measurement range	0 V to ±300 V
Ranges	10 mV to 1000 V, 20 dB steps
Maximum reading	12000 counts
Time of triggered measurement	32 ms to 60 s (selectable)
Accuracy	±(0.1% of rdg + 10 counts)
General data	
Power supply	100/120/240 V ±10%, 230 V -10%/+6%, 47 Hz to 440 Hz (25 VA)
Dimensions (W × H × D)	219 mm × 103 mm × 350 mm
Weight	4.5 kg

Ordering information

RMS Voltmeter	R&S®URE2	0350.5315.02
RMS/Peak Voltmeter	R&S®URE3	0350.5315.03
Input/Output Option	R&S®URE3-B2	0351.1513.02



Contents Overview

Chapter Overview

Type Index

R&S Addresses

