

# News from Rohde & Schwarz



High-end network analyzer for demanding tasks in the lab

ILS / VOR analyzer – specialist for terrestrial air navigation analysis

Ready for on-site operation in just minutes – transportable microwave monitoring system

2005/IV

188



**ROHDE & SCHWARZ**

The new generation of R&S®ZVA high-end network analyzers offers high measurement speed, maximum dynamic range and extremely high versatility and accuracy – ideal prerequisites for complex measurement tasks. On top of this, it features an easy and intuitive operating concept (page 26).



44 466



The WLAN Protocol Tester R&S®PTW 70 of course provides all functions required for conformance tests. But it far exceeds these standard requirements... (page 22).

The R&S®ZVA is outstanding for its superior RF performance combined with versatile use and extendability (page 26).



## MOBILE RADIO

### TETRA radio systems

TETRA Mobile Radio System *ACCESSNET®-T*

Scalable PMR networks: The architecture is what counts ..... 4

### Radiocommunications testers

Universal Radio Communication Tester R&S®CMU 200

Measurements and signaling tests in the dual transfer mode ..... 8

Adjustment of polar modulators in production ..... 12

R&S®CMU 200 / R&S®CTRU-G / -W

Standardized test solutions for PoC mobile phones ..... 14

Bluetooth® RF Testers R&S®CBT / R&S®CBT 32

Transmitter and receiver measurements for Bluetooth® V2.0 + EDR ..... 16

### Signal generators

Vector Signal Generator R&S®SMU 200 A

Signals for testing multicarrier power amplifiers ..... 19

## WPAN / WLAN / WWAN

### Protocol testers

WLAN Protocol Tester R&S®PTW 70

Multimode protocol analysis in WLANs ..... 22

## GENERAL PURPOSE

### Network analyzers

◁ Vector Network Analyzer R&S®ZVA

High-end network analyzer – future-proof and extremely fast ..... 26



The ILS / VOR Analyzer R&S®EVS 300 is used to check terrestrial air navigation equipment at national and international airports. It is a portable and versatile instrument that is fully optimized for high measurement accuracy (page 32).



The Transmitter Control Unit R&S NetCCU® 800 is included as a common distributing center both in the new generation of R&S®NH/ NV 8200 TV transmitters and in the new family of VHF FM Transmitters R&S®NR 8200 (page 44).

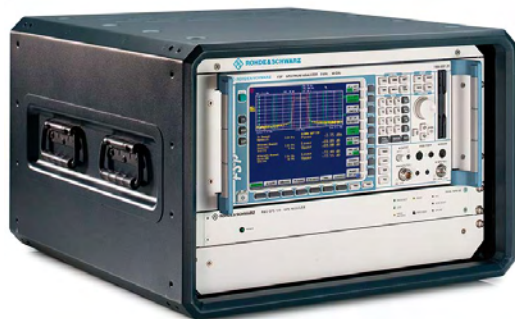

The Transportable Microwave Monitoring System R&S®TMS 500 is well-protected in a portable rack, enabling quick and easy setup on site, and is ready for operation within only a few minutes (page 47).

## Signal analyzers

- ◀ ILS/VOR Analyzer R&S®EVS 300  
The specialist for terrestrial air navigation analysis ..... 32

## Signal generators

- Signal Generators R&S®SMx  
Perfectly simulated: GPS signals for complex localization scenarios..... 36

## BROADCASTING

### Monitoring receivers

- DTV Monitoring Receiver R&S®ETX-T  
Trust is good, control is better – DVB-T monitoring ..... 38

### Test methods

- Generating and analyzing transport streams for DVB-H ..... 42

### TV transmitters

- ◀ Control Unit R&S NetCCU® 800  
Common control unit for FM and TV transmitters..... 44
- Central cooling systems for high-power TV and DVB-T transmitters..... 46

## RADIOMONITORING

### Monitoring systems

- ◀ Transportable Microwave Monitoring System R&S®TMS 500  
Transportable monitoring system for frequencies up to 110 GHz..... 47

## MISCELLANEOUS

- Newsgrams ..... 50

Published by Rohde & Schwarz GmbH & Co. KG · Mühldorfstrasse 15 · 81671 München  
 Support Center: Tel. (+49) 01805 124242 · E-mail: customersupport@rohde-schwarz.com  
 Fax (+49 89) 41 29-13777 · Editor and layout: Ludwig Drexl, Redaktion – Technik (German)  
 English translation: Dept. 9UK7 · Photos: Rohde & Schwarz · Printed in Germany · Circulation (German,  
 English, French, Russian and Chinese) 90 000 approx. 4 times a year · ISSN 0028-9108 · Supply free of  
 charge through your nearest Rohde & Schwarz representative · Reproduction of extracts permitted if source  
 is stated and copy sent to Rohde & Schwarz München.

R&S® is a registered trademark of Rohde & Schwarz GmbH & Co. KG. Trade names are trademarks of the owners. CDMA2000® is a registered trademark of Telecommunications Industry Association (TIA USA). The Bluetooth® word mark and logos are owned by the Bluetooth SIG, Inc. and any use of such marks by Rohde & Schwarz is under license.

TETRA Mobile Radio System *ACCESSNET*<sup>®</sup>-T

## Scalable PMR networks: The architecture is what counts

**The Mobile Radio Communications Architecture IpMCA<sup>®</sup> from Rohde & Schwarz defines a comprehensive technical and commercial requirements profile for digital PMR networks [1]. If these requirements are taken into account when planning mission-critical communications networks and are completely fulfilled in the implementation phase, there will be nothing to stop these networks from being adapted quickly and cost-effectively during their entire operational life.**

### In constant change

PMR networks undergo constant, sometimes manifold changes. The causes for this are always linked directly or indirectly to the users in the network: The subscriber community may grow, alter its structure or be geographically rearranged – which always results in the need to adapt the digital infrastructure. Quick, cost-effective adaptation of these professional networks should be possible during their entire operational life. PMR networks must therefore be scalable in at least the three following dimensions:

- ◆ The **radio coverage** of the area to be covered and the **channel capacity** of individual network elements if subscriber density increases
- ◆ The **number of subscribers** organized in closed user groups
- ◆ The **availability of individual network elements** (scalable redundancy)

### Scalability of radio coverage and channel capacity

A cellular TETRA network is usually set up in two stages. In the first stage, it is made certain that the coverage area has enough base stations for transmitting signals in compliance with quality requirements. One of the characteristics of quality radio coverage is sufficient overlapping of the coverage areas of adjacent base stations to ensure reliable handover of calls as mobile subscribers move from cell to cell.

When a network is being planned, the communications capacity to be provided by the network is distributed on the basis of the assumed subscriber densities. For example, base stations in rural areas normally require fewer channels than those in urban areas.

As the number of subscribers rises, however, it is usually necessary in a second stage to add channels to base stations and to increase the capacity of the exchanges involved for routing and switching or even to install additional base stations.

The requirements defined in the Mobile Radio Communications Architecture IpMCA<sup>®</sup> specify the unlimited compatibility of the network elements, regardless of how large a network is. The *ACCESSNET*<sup>®</sup>-T TETRA mobile radio network from Rohde & Schwarz fully meets this requirement. All network elements of the same type are compatible and can continue to be used if the network is expanded – no matter whether the network is a small, single-cell TETRA system or a nationwide network with hundreds of base stations.

**FIG 1** Too many base stations to be connected? No problem! Cascading the System Node IpSN<sup>®</sup> (photo) allows you to connect up to 120 base stations.



Number of System Nodes IpSN <sup>®</sup>	Number of base stations	Configuration
1	36	In a network with only one exchange
1	30	In a network with multiple exchanges
2	60	
3	90	
4	120	

*ACCESSNET*<sup>®</sup>-T base stations are available as indoor or outdoor models, and each can have one to eight carriers. The new System Node IpSN<sup>®</sup>, whose capacity can be increased to supply up to 120 base stations, is used as an exchange (FIG 1).

A number of System Nodes IpSN<sup>®</sup> can also be interconnected in a nonhierarchical, meshed configuration. This not only makes it possible to configure very large networks but also, as described further below, provides a basis for mission-critical, highly available mobile radio networks.

### Adapting a network to the number of subscribers and user groups

Theoretically IpMCA<sup>®</sup> does not limit the number of subscribers, but in reality this number is limited by the communications capacity installed and the agreed-on quality of service (QoS). Of particular importance with regard to mission-critical communications networks is the ability to manage closed user groups (virtual private networks, VPNs). A network must be able to adapt flexibly to rising subscriber numbers or additional user groups.

In VPNs several user groups share a common network, but the parts of the network allocated to each group remain hidden from the other groups. This also affects access to resources that is exclusively assigned to the different VPNs. VPNs are thus characterized by the following:

- ◆ Individualized physical address ranges in which calling numbers can be assigned in accordance with the organization's own concept as to how it should be mapped
- ◆ Assigned subscriber management

- ◆ Own key management and authentication (in the case of end-to-end encryption)
- ◆ Own accesses to private automatic branch exchanges (PABXs)
- ◆ Own control centers
- ◆ Own voice recording
- ◆ Own IP access points (IAPs) for routing to the organization-internal intranet for packet-oriented data transmission (IP over TETRA)
- ◆ Own software applications that provide user-group-specific solutions

Here, too, there is no objective limitation to the number of definable VPNs. What matters are the technical properties of the network elements and components – for example, whether the network management system supports sep-

arate subscriber management for different address ranges and the associated calling numbers or whether all features that will be required later can be implemented in the mobile radio network.

*ACCESSNET*<sup>®</sup>-T demonstrates that it meets all the requirements for managing VPNs and integrating the necessary technical resources. For example, a network may contain a number of application servers that, in turn, each run several software applications. This also applies to control centers, PABX switches and voice recording. The network management system allows shared management of separate subscriber addresses and coupling of VPN-specific key management (FIG 2).

FIG 2 *ACCESSNET*<sup>®</sup>-T networks can be combined and expanded to meet your needs.

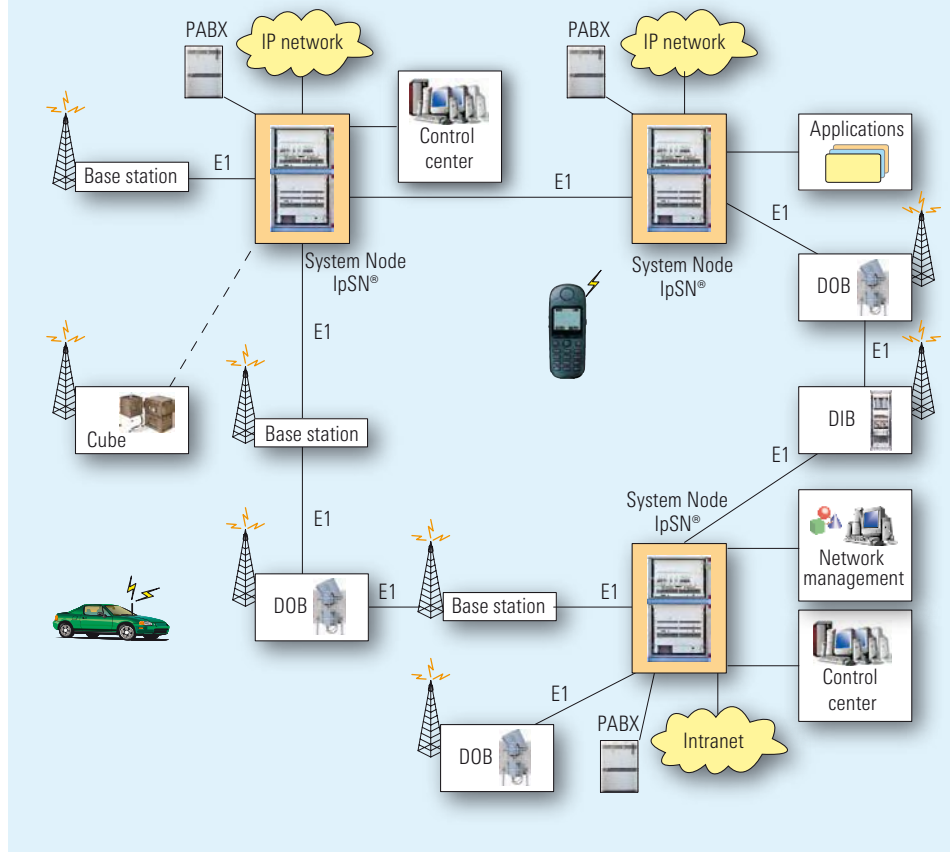

### ► Redundancy based on needs

The overall availability of PMR networks is generally very high. However, this does not take into account threat scenarios that are not caused by technical problems. However, mission-critical communications networks must be safeguarded not only against technical failures, but also against uncontrollable natural phenomena as well as against vandalism or acts of terror.

Besides these aspects, it is important to know where failures occur. For example, the failure of radio coverage in an uninhabited wooded area must be evaluated differently than the failure of a cell containing a facility that requires special protection. Essential with all failures is how quickly they can be eliminated. In ideal cases, the system automatically remedies the failure; in extreme cases, the affected network elements have to be replaced by mobile units, for example by the *ACCESSNET*<sup>®-T</sup> Cube [2].

These considerations resulted in the concept of scalable redundancy in the IpMCA<sup>®</sup> requirements profile, for these security aspects affect not only the number of System Nodes IpSN<sup>®</sup> and their configuration but also the cost of the required connection network. *ACCESSNET*<sup>®-T</sup> therefore includes redundancy measures that provide protection against the failure of elementary functional units such as exchanges, base stations, tie lines, gateways to other networks and application platforms (FIG 3).

Site redundancy is the capability of the network to maintain operation if an exchange fails. To ensure this, the base stations must be connected to the exchanges of different sites. Each exchange must be able to handle the overall traffic of the redundantly connected base stations (FIG 4). Site redundancy is relatively cost-effective – it requires merely a second site with a System Node IpSN<sup>®</sup> and the linking of the base station using a ring or line structure.

The strength of scalable redundancy measures in mission-critical *ACCESSNET*<sup>®-T</sup> mobile radio networks lies in the combination of different methods (FIG 5). In this example, the greatest network availability is in area A, which features site redundancy and in which the base stations are interconnected by an open ring. Redundant network switches and application platforms make the network even more failsafe.

There is less availability in area B, which has a ring structure with a single exchange. In area C, the redundancy measures in the event of a line interruption are limited to the autonomous operation of the base stations and the use of dialup lines. Measures such as radio overlapping and standby circuits of a control channel can, of course, be used independently of the redundancy measures.

The overall availability of *ACCESSNET*<sup>®-T</sup> mobile radio networks can be further increased by applying the cluster concept (FIG 6). This extremely high avail-

FIG 3 Numerous redundancy measures make *ACCESSNET*<sup>®-T</sup> networks highly available.

Network element	Redundancy measure	Ensured function
System Node IpSN <sup>®</sup>	Full redundancy (provided in dual configuration)	Exchange
	Site redundancy	Base stations in the network remain operational if there is a simple line interruption or if an exchange fails
Base station	Full redundancy (provided in dual configuration)	Radio coverage of cell in network operation
	Autonomous fallback operation	Radio coverage without network
	Radio overlapping	Radio coverage with few gaps
	Dynamic switching of control channel	Network operation at decreased capacity
Lines	Topological measures (e.g. ring structure)	Base stations in the network remain operational if there is a simple line interruption
	Dialup lines for alternative routes (ISDN S <sub>0</sub> )	Base stations in the network remain operational if the dedicated connection fails
Network switches, application platforms	Redundant units at exchanges (provided in dual configuration)	Availability of network switches and applications, if necessary with reduced capacity

ability is aimed at the special requirements in security networks for police forces. This concept uses full redundancy on site in the form of half-clusters coupled with site redundancy, i.e. half-clusters are set up at different sites. Topologically this example can be further expanded by chains of base stations between the half-clusters that do not manage shared base stations, e.g. between half-clusters 1 and 3.

## Summary

Because mission-critical PMR networks undergo dynamic changes during their operational life, the Mobile Radio Communications Architecture IpMCA® places special emphasis on the scalability of such networks. This is fully implemented in *ACCESSNET*®-T, the IpMCA®-based TETRA network infrastructure from Rohde&Schwarz. This comprehensive scalability is the basis for the outstanding flexibility with which network operators can respond to changing requirements and conditions for mission-critical mobile radio networks – cost-effectively and during their entire operational life.

Max Zerst

More information on the comprehensive program for TETRA at [www.rohde-schwarz.com](http://www.rohde-schwarz.com) ("Trunked Radio" menu)

### REFERENCES

- [1] Mobile Radio Communications Architecture IpMCA®: Future-proof IP-based communications architecture. News from Rohde & Schwarz (2005) No. 187, pp 9–11
- [2] TETRA Mobile Radio System *ACCESSNET*®-T Cube: Autonomous modular TETRA system – portable and quick to set up. News from Rohde & Schwarz (2005) No. 184, pp 4–7

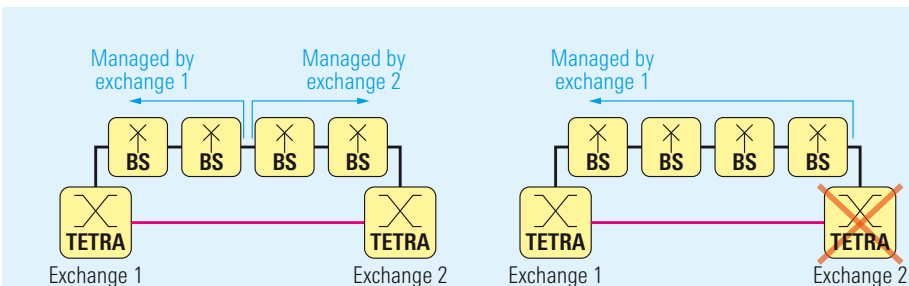

FIG 4 Site redundancy: If exchange 2 fails, exchange 1 takes over.

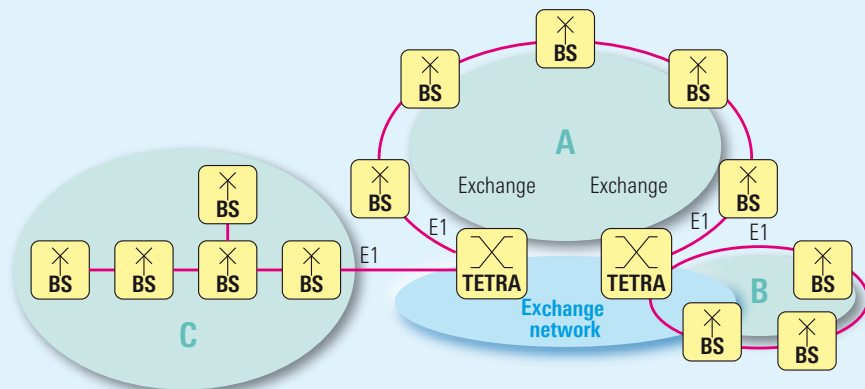
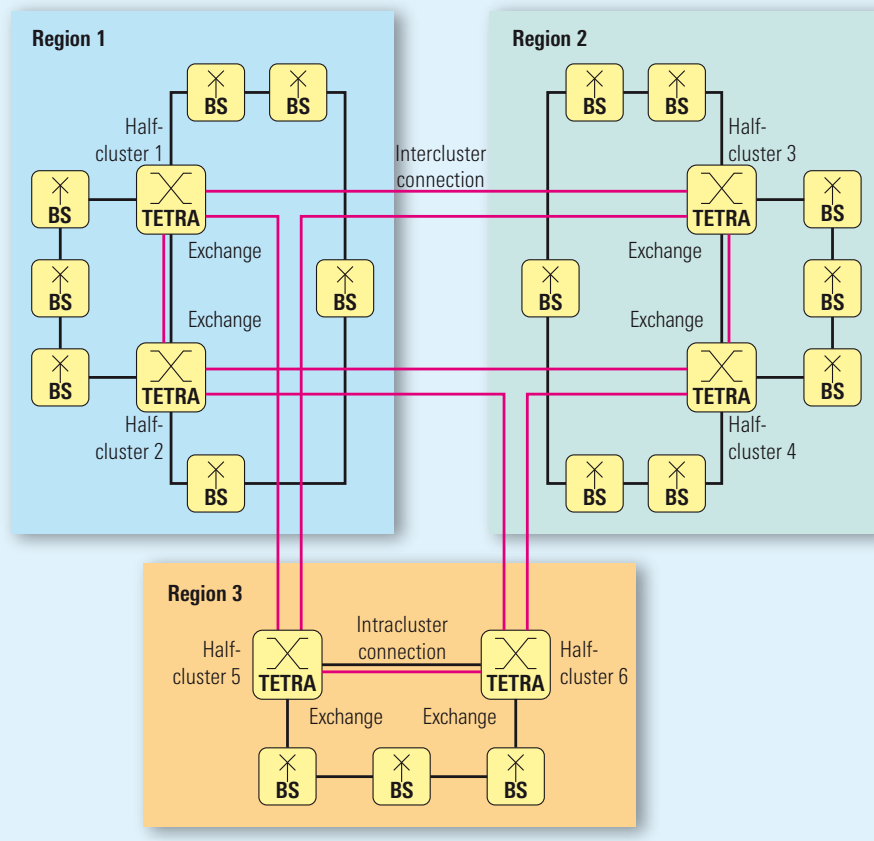

FIG 5 Example of a network with different redundancy measures..

FIG 6 Example of a network with extremely high availability.



## Universal Radio Communication Tester R&amp;S®CMU200

# Measurements and signaling tests in the dual transfer mode

**The dual transfer mode (DTM) – an expansion of the GSM mobile radio standard – permits voice telephony and data transfer at the same time.**

**The R&S®CMU200 is well prepared to meet these requirements: With the R&S®CMU-K44 software option, the mobile radio tester can simulate a DTM-compatible GSM base station and thus perform a variety of measurements and signaling tests on mobile radio devices.**

## Both voice and data connections

The use of mobile phones has undergone amazing changes in recent years. While voice communication was the clear focus at the beginning, data transfer in the form of e-mails, documents or SMS/MMS as well as the use of the Internet is becoming increasingly important. This is a result of the technical progress.

Simultaneous transmission of voice and data is made possible by the dual transfer mode, an expansion of the GSM mobile radio standard. While talking to somebody on the mobile phone, you can receive e-mails. Or you can make a phone call while a large document is being transmitted. When expanded with the R&S®CMU-K44 software option, the

Universal Radio Communication Tester R&S®CMU200 can perform measurements in the dual transfer mode. Since the R&S®CMU200 has a modular and flexible hardware concept, hardware expansions or modifications are normally not required for the dual transfer mode.

## Three classes

The GSM standard differentiates between three classes of mobile radio devices:

- ◆ **Class A** Voice and data connection possible at the same time
- ◆ **Class B** Voice and data connection possible, but not at the same time.
- ◆ **Class C** Only voice or only data connection possible; manual switchover may be possible between voice and data operation

FIG 1 DTM multislot classes and their characteristics.

Multislot class	Max. number of downlink slots	Max. number of uplink slots	Max. sum of uplink and downlink
5	2	2	4
6	3	2	4
9	3	2	5
10	4	2	5
11	4	3	5
31, 36	5	2	6
32, 37	5	3	6
34, 39	5	5	6
41	6	2	7
42	6	3	7
45	6	6	7

Packet-data connection mode	Description
GPRS test mode A	The mobile radio device generates pseudo random data packets and sends these to the R&S®CMU200 in the uplink.
GPRS test mode B	The R&S®CMU200 generates pseudo random data packets in the downlink which are returned by the mobile radio device in the uplink.
BLER	The R&S®CMU200 sends data packets in the downlink to the mobile radio device. The BLER measurement can be started in this connection mode.
EGPRS loopback	The R&S®CMU200 generates pseudo random data packets in the downlink which are returned by the mobile radio device in the uplink. In contrast to test mode B, the data in the mobile radio device is returned after the demodulator and not sent to the channel coder. This connection mode is only defined for EGPRS coding schemes.



Only class A mobile radio devices can support the dual transfer mode. These devices communicate their DTM multislot classes for GPRS and EGPRS when logging on to the network and the R&S®CMU200 displays the classes in the Overview menu. FIG 1 illustrates the multislot classes defined for the dual transfer mode and their characteristics.

## Perfect operation

The dual transfer mode was perfectly integrated into the R&S®CMU200 operating concept – not a single menu or control element had to be changed. Users can quickly master instrument operation and existing remote-control test programs can continue to be used.

A DTM connection exists when the circuit-switched part of the R&S®CMU200 is in the *Call Established* state and the packet-data part is in the *TBF Established* state at the same time. Previously, you had to select between a cir-

cuit-switched or a packet-data connection prior to setting up a call via the main service. With the DTM option, you can even switch between the circuit-switched and packet-data menus while a connection exists.

## Parameterization

The dual transfer mode also ensures highly flexible parameterization of the R&S®CMU200 for the circuit-switched part and the packet-data part of a DTM connection: Almost all parameters maintain their functions. Frequency hopping or timing advance is possible, for example. FIGS 2 and 3 show the connection modes that can be set in the packet-data part and in the circuit-switched part of a DTM connection. You can combine the connection modes in any manner you wish.

You can also configure timeslots however you wish: just select the timeslots to be used in the configuration editor

and set the desired level on the right (FIG 4).

*DTM CS Timeslot* in the configuration editor defines the timeslot for the circuit-switched part of the DTM connection; *Main Timeslot* defines the main timeslot for the packet-data part. While only one uplink and downlink timeslot is used for the circuit-switched part, you can configure more than just the main timeslot for the packet-data part depending on the DTM multislot class of the mobile radio device.

## Signaling

A voice connection must be present to set the mobile radio device to the dual transfer mode. You can then activate the packet-data part and establish a data connection as well. You can run signaling routines to dynamically modify parameters such as channel or timeslot change, and make modifications to the timeslot configuration, to the packet-

FIG 2 Connection modes in the packet-data part of the DTM connection.

FIG 3 Connection modes in the circuit-switched part of the DTM connection.

Circuit-switched connection mode	Description
Full rate version 1	Standard voice channel coding at full data rate
Half rate version 1	Standard voice channel coding at half data rate
Full rate version 2	Channel coding with improved voice quality and full data rate
AMR full rate (option R&S®CMU-K45 required)	Adaptive multi rate voice connection at full data rate
AMR half rate (option R&S®CMU-K45 required)	Adaptive multi rate voice connection at half data rate

FIG 4 Editor for uplink and downlink timeslots.

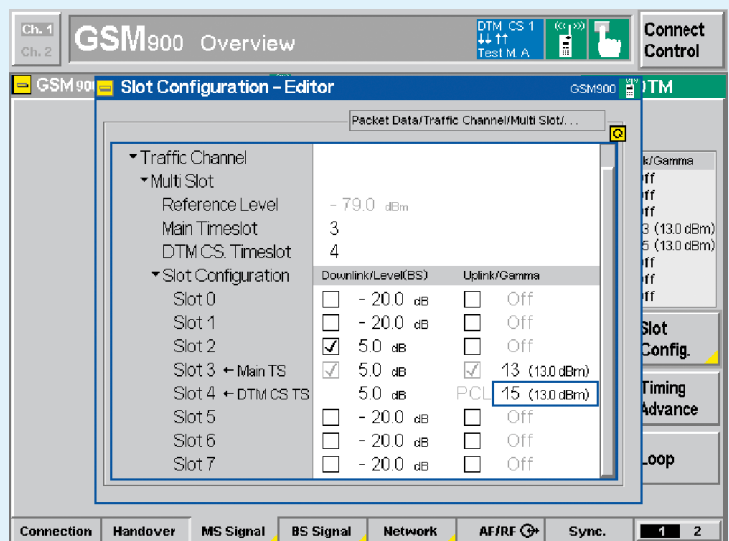

- ▶ data coding scheme or to the circuit-switched traffic mode in the usual manner during a DTM connection.

You can use the Message Viewer R&S®CMU-Z49 to visualize the signaling process and display or analyze the contents of each message (FIG 5).

## Transmitter measurements

Transmitter measurements are used to check the RF characteristics of the transmit section in the mobile radio device. Since EGPRS- and DTM-supporting mobile radio devices using modulation modes GMSK and 8PSK can transmit data on different timeslots while a DTM connection is established, you can check both modulators with only a single measurement. The circuit-switched timeslot of a DTM connection is always GMSK-modulated while the packet-data timeslot can also be 8PSK-modulated.

The power-versus-time measurement graphically displays the power ramp characteristic of the mobile radio device (FIG 6). Compliance with the tolerance limits defined in the GSM standard can thus be checked at a glance.

## Receiver measurements

Receiver measurements check the reception quality of the mobile station receiver. The measuring principle is based on the fact that low RF-level random data is sent to the mobile radio device in the downlink. The mobile radio device then returns high RF-level data in the uplink. The R&S®CMU 200 compares sent data and received data and calculates the error ratio. This calculation is based on an ideal uplink so that transmission errors do not occur.

The bit error ratio (BER) is measured via the circuit-switched part of the DTM

connection. In this case, random data is sent to the mobile radio device which returns the data to the R&S®CMU200 unchanged (FIG 7).

The block error ratio (BLER) is measured on the packet-data part of the DTM connection. In this case, data blocks with random data are sent to the mobile radio device (FIG 8). In the uplink mode, the mobile radio device acknowledges the receipt of error-free data blocks by sending ACK/NACK messages. The R&S®CMU 200 then calculates the block error ratio (total and per slot) and the data transmission rate achieved.

## Ultrafast in production

During a DTM connection, you can simultaneously run the BER and BLER measurements in the remote-control mode. This reduces the test time for a mobile radio device to a minimum.

Dir	Name	log. Channel
RX	DL-RA-Ind	RACH
TX	Immediate Assignment	AGCH
RX	CM Service Req	FACCH
TX	System Info Type 6	SACCH
TX	CM Service Accept	FACCH
TX	System Info Type 5	SACCH
RX	CC Setup	FACCH
TX	CC Call Proceeding	FACCH
TX	Channel Mode Modify	FACCH
RX	Channel Mode Modify Ack	FACCH
TX	Alerting	FACCH
TX	CC Connect	FACCH
RX	CC Connect Ack	FACCH
TX	DTM Assignment Command	FACCH
RX	Assignment Complete	FACCH
TX	GPRS Test Mode Cmd	GPRS
RX	Packet Downlink Ack	GPRS
RX	Packet Downlink Ack	GPRS
TX	Packet Uplink Assignment	GPRS
RX	Packet Downlink Ack	GPRS
RX	Packet Downlink Ack	GPRS
RX	Packet Control Ack	GPRS
TX	DTM Assignment Command	FACCH
RX	Assignment Complete	FACCH
RX	CC Disconnect	FACCH
TX	CC Release	FACCH
TX	Packet Uplink Ack	GPRS
RX	CC Release Complete	FACCH
TX	Channel Release	FACCH

FIG 5 Display of message sequence with Message Viewer R&S®CMU-Z49: call setup and release of a DTM connection in the GPRS test mode.

FIG 6 Power-versus-time measurement with 8PSK modulation in the packet-data part and GMSK modulation in the circuit-switched part.

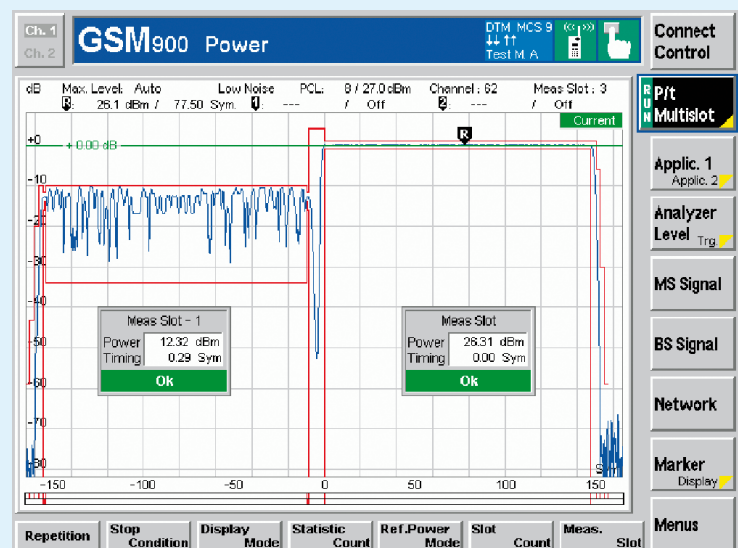

In addition to the signaling tests, the R&S®CMU200 also offers the reduced signaling mode which is used during production testing. Mainly RF characteristics of mobile radio devices are checked. This mode allows you to skip parts of the signaling and thus reduces the test time per mobile radio device. The complete reduced signaling mode has also been implemented for DTM connections.

All operating steps of the dual transfer mode can be fully remote-controlled via the IEC/IEEE bus interface.

### Summary and future developments

The R&S®CMU-K44 DTM software option expands the Universal Radio Communication Tester R&S®CMU200 to include a feature that will be supported by almost any modern future mobile phone. The

largest manufacturers are currently expanding their mobile radio devices to include the dual transfer mode. The R&S®CMU200 is an innovative tester that is extremely useful both in development and production.

Peter Seelbach

More information and data sheet at [www.rohde-schwarz.com](http://www.rohde-schwarz.com) (search term: CMU200)

#### REFERENCES

- Technical Specification 3GPP TS 43.055, Dual Transfer Mode, 3rd Generation Partnership Project, Technical Specification Group GSM/EDGE
- Universal Protocol Tester R&S®CRTU-G Test cases for dual transfer mode in GSM/(E)GPRS networks. News from Rohde & Schwarz (2005) No. 185, p 7

FIG 7 Measurement of bit error ratio on the circuit-switched timeslot of a DTM connection.

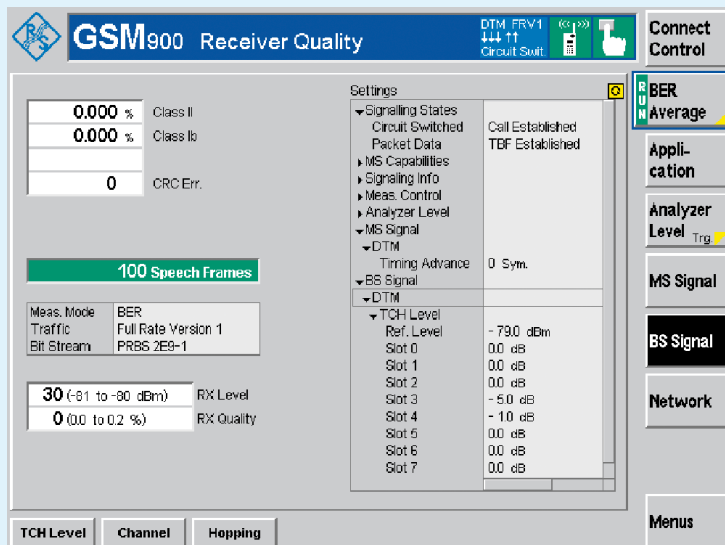
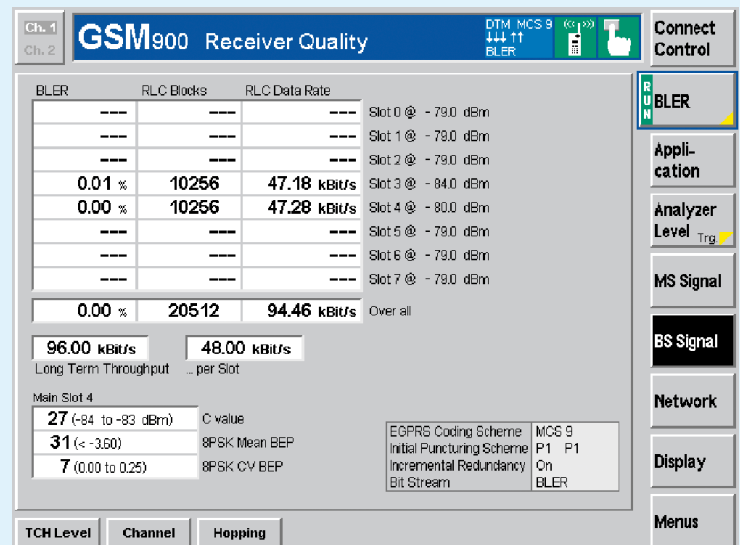

FIG 8 Measurement of block error ratio on the packet-data timeslots of a DTM connection.



## Universal Radio Communication Tester R&amp;S®CMU200

# Adjustment of polar modulators in production

**Polar modulation is being used to an increasing extent to keep costs, size and power consumption of 2.5G mobile radio terminals to a minimum. However, power amplifiers in polar modulators are operated to improve efficiency in the nonlinear characteristic area. This leads to distortions and thus to an unwanted increase in modulation errors and adjacent-channel leakage. You can tackle this problem by means of signal pre-distortion with customized AM/AM and AM/ $\phi$ M characteristics; however, this requires the output stage characteristics to be determined quickly and effectively in production.**

## Principle of the polar modulator

FIG 1 shows the basic design of a polar modulator. After the I/Q baseband is generated, the signal is converted to polar coordinate format with magnitude and phase. In the case of modulation modes with constant envelopes (e. g. GMSK in GSM), the phase path is connected directly with the phase modulator and the VCO. During simultaneous amplitude modulation (e. g. 8PSK in EDGE), the AM path directly modulates the output stage. To compensate distortions, which occur due to output stage operation in the nonlinear characteristic area, predistortion is performed. In the ideal case, you can achieve a linear signal chain and thus a sufficiently narrow modulation spectrum.

## Determining the output stage characteristic

Even low nonlinearities of the output stage increase adjacent channel leakage. To prevent this, you must have exact knowledge of the output stage characteristic so that correct predistortion is possible. Since the AM/AM and AM/ $\phi$ M characteristics generally scatter strongly in series production, you have to measure the characteristic of each output stage separately – and as quickly and reliably as possible.

## I/Q versus slot measurement

The Universal Radio Communication Tester R&S®CMU200 with Firmware Option R&S®CMU-K48 allows you to determine the AM/AM and AM/ $\phi$ M characteristic of a power output stage. The test signal necessary for this is generated directly in the baseband of the chip-set to be tested. FIG 2 shows the test setup and signal flow. The signal generated in the DUT passes through the entire signal chain and is analyzed in the R&S®CMU200. The controller performs the final comparison of the nominal test signal with the actual test signal and the calculation of the characteristic.

## Signal form and processing in the R&S®CMU200

FIG 3 shows an example of the amplitude and phase of the staircase signal at the input and output of the output stage. To perform an exact phase measurement in addition to the amplitude measurement, the R&S®CMU200 coherently synchronizes to the transmitted carrier. To do this, the mobile radio tester estimates the frequency at all level stages and subsequently corrects the test signal by the average value of the estimated frequency offsets. In the ideal case, the blue phase characteristic is the result, which exhibits only the AM/ $\phi$ M influence. By complex averaging you can then determine a complex I/Q value pair for any measurement interval ( $S_n$ ). These results can then be compared with the nominal values in the controller and further processed to obtain the actual AM/AM and AM/ $\phi$ M predistortion characteristic.

FIG 1 Basic design of a polar modulator.

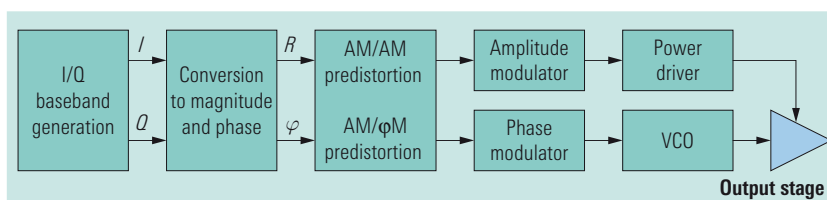

## Phase drift compensation

Since the local oscillators of the R&S®CMU 200 and the DUT are not coupled, an irregular drift occurs in the phase characteristic. During normal recording lengths of >50 ms, the test result would be unusable, since the phase shifts to one direction or the other as the test period increases. Further measures are necessary to distinguish this drift from the one caused by the AM/φM characteristic.

The solution to this problem is a special waveform that allows compensation of the drift. FIG 4 shows such a signal characteristic after it has been processed in the R&S®CMU 200 (for the sake of clarity, in two colors, black and yellow). The amplitude characteristic is selected in such a manner that a reference measurement step (black) follows each measurement step (yellow). The measurement steps pass through all desired signal amplitudes at which reference points are to be recorded for the AM/AM and AM/φM characteristic. Between the measurement steps, the reference measurement steps are at a constant level. Accordingly, the associated phases include only the phase drift but no AM/φM contribution. Assuming that the phase drift between two adjacent stages is negligible, you can compensate the phase drift error by calculating the difference between measurement and reference phases. The phase characteristic (orange) caused by the AM/φM characteristic is the result.

Rolf Lorenzen

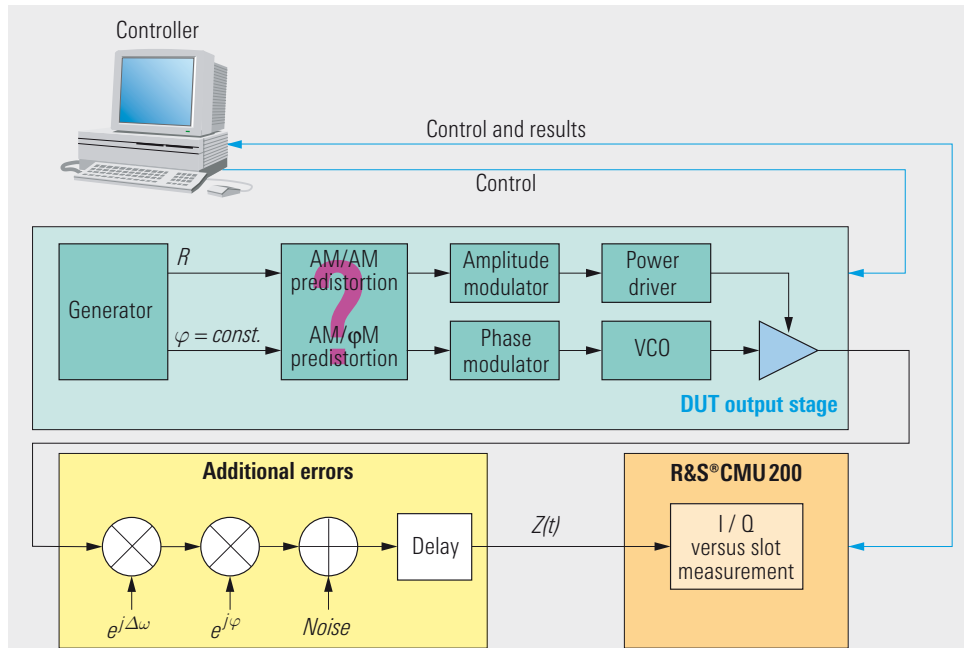

FIG 2 Test setup for determining the AM/φM characteristic of an output stage.

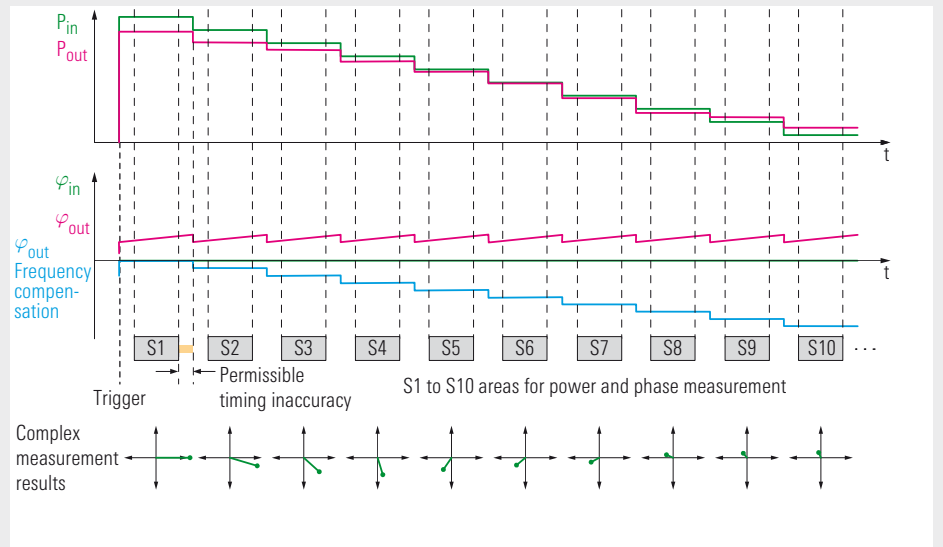

FIG 3 Example of amplitude and phase of the staircase signal at the input and output of the output stage.

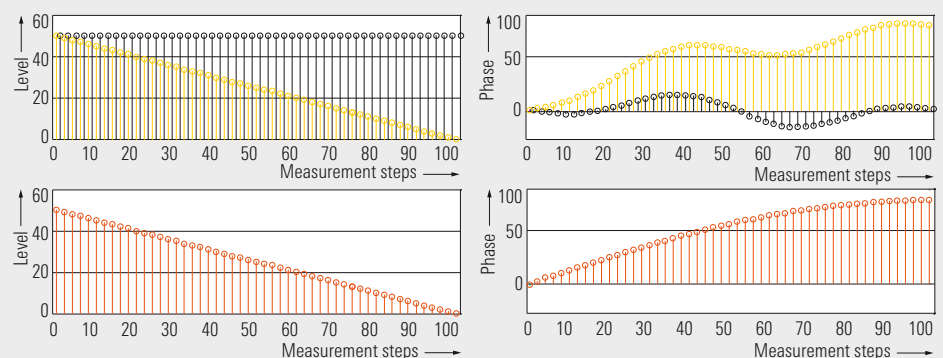

FIG 4 Phase drift compensation with special measurement signals.

R&amp;S® CMU200 / R&amp;S® CTRU-G / -W

## Standardized test solutions for PoC mobile phones

**PoC (push to talk over cellular), the modern version of walkie-talkie communication, is a very promising new voice communications service in mobile radio networks. Voice messages are directly sent to one or more predefined subscribers at a keystroke. This bidirectional radio service – also used as PTT (push to talk) with only slight differences – is based on packet-switched voice transmission in GPRS, WCDMA(UMTS) or CDMA2000® networks, for example. This new form of group communications opens up new possibilities both for business customers and private users and is thus a cost-efficient alternative to telephony and SMS.**

### PoC – go ahead!

As with the classic transceiver, you just press a key on your PoC mobile phone to communicate by radio. In contrast to most conventional voice services with full-duplex transmission methods allowing both talking and listening at the same time, PoC is a semiduplex method: Only one subscriber at a time can talk. All others have to listen. The spatial limitation of current walkie-talkie communications has largely been eliminated owing to roaming in mobile radio networks. The PoC voice service works well in the complete mobile radio network, even across borders.

PoC is of interest primarily for closed user groups that have to communicate over large distances. In the US, for example, PTT has been used for years

to ensure interruption free communication between couriers and their employers. And during the world bob sleigh racing championship in Oberhof, the assistants were also communicating via PTT. But also in private life, parties can work out a time and place to meet each other far more efficiently, faster and cost-effectively than per SMS or a number of lengthy phone calls.

Many mobile phone companies believe that PoC is going to become a real trend. Based on approx. 17 million PTT users in the US today, conservative estimates go up to more than 100 million subscribers worldwide for the year 2008. The impetus for the target growth will largely come from the demand in the business customer segment. According to network providers, PoC is supposed to be more cost-efficient for users than SMS.

FIG 1 Setup of mobile radio network with PoC service.

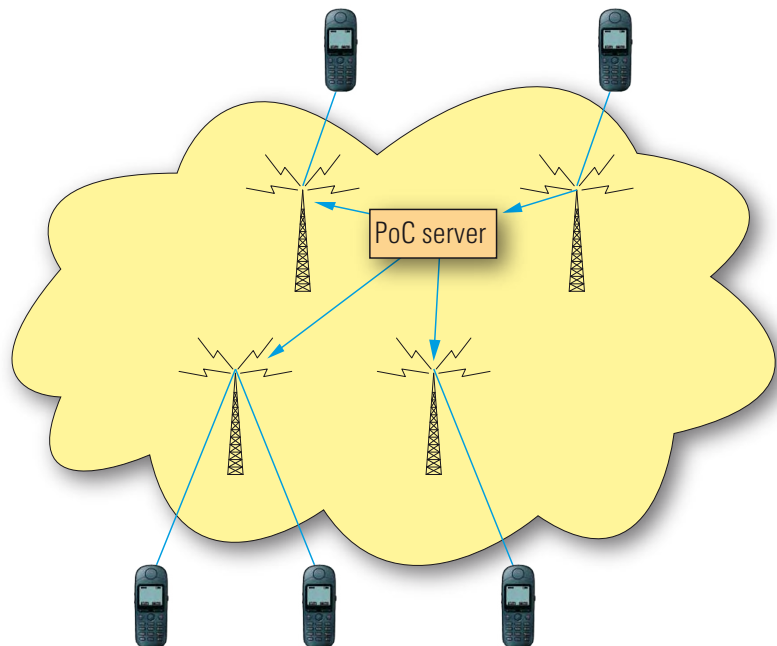

The cost-effectiveness of this service together with a wide range of different mobile phones and their blanket use will probably be the main reason for further acceptance of PoC.

## Standard on its way

As currently only a few proprietary PTT solutions including the known restrictions exist, a uniform standard would be the missing link to mass market. In early 2003, a proposal for a standardized PoC solution was developed and submitted to the Open Mobile Alliance (OMA) standardization committee. Half-way through the year 2005, the committee announced the availability of the first open standard for PoC, a standard fully independent of the mobile radio technology used. The next step was the publication of specified test cases which are used to check compliance with the standard. FIG 1 illustrates the schematic overview of a mobile radio network offering PoC services.

PoC is based on the IP multimedia subsystem (IMS) standardized by 3GPP. This is a multimedia switching technique describing different IP-based multimedia applications. IMS forms the basis for the packet-switched transmission of multimedia data; it manages setup, control and the release of connections. Special realtime protocols (RTP, RTCP, TBCP) additionally ensure optimum voice transmission via the data network. Also, QoS (quality of service) has already been defined in IMS for the various network types.

Many network operators will soon offer access to IMS networks and many mobile phones will be equipped with a PoC client in line with open industry standards. This ensures trouble-free communication with the devices of other manufacturers and the infrastructure of most network operators. Moreover,

IMS is the control level of future innovative services such as video transmission, multimedia messaging and virtual reality applications.

## How PoC works

The voice message is converted to a data stream, packed in data packets and sent to the PoC server of the network operator via radio. The data packets find their way through the data network by means of the Internet protocol (IP). The voice communication service is based on a client-server architecture. The PoC client on the mobile phone uses the services of the PoC server in the network. The PoC server transmits the incoming data stream to one or more receivers and the data stream is received there with only a few seconds delay. One message thus reaches many receivers at a time. To control correct communication, the PoC server additionally takes over signaling and ensures that only one subscriber can transmit data and use the voice channel. It also controls the specified communications groups.

## Allround test solutions offered by Rohde & Schwarz

Based on the R&S®CRTU-ATE application test environment software platform, Rohde & Schwarz now also offers test solutions for PoC (FIG 2) in addition to MMS [1]. These test solutions include the Test Server R&S®CA-AA02 which offers a standardized reference to developers of PoC clients. The Test Server R&S®CA-AA02 supports the session types 1-1, Ad-Hoc, Prearranged and Chat and ensures that group subscriber lists can dynamically be created and changed by the mobile phone. Moreover, the associated test cases will be available under the product name R&S®CA AC02 after publication of the corresponding specification. Once vali-

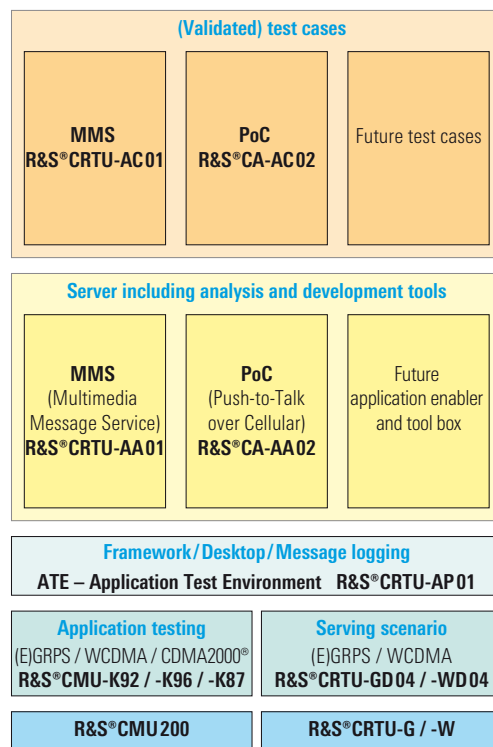

FIG 2 The test solutions of Rohde & Schwarz for MMS and PoC.

dated, these test cases will then make it possible to certify the PoC functionality of mobile phones. Both PoC servers and the specified test cases will form a test environment at the application level that is most important to software engineers as regards the implementation, test and specification of the PoC functionality.

Both servers and the PoC test cases have been implemented as software products running on PCs based on Windows®. The link between the mobile phone and the PC is either the Universal Radio Communication Tester R&S®CMU200 or the corresponding devices of the R&S®CRTU protocol tester family. These devices simulate a mobile radio network and make it possible to call up any IP-based applications of a mobile phone such as PoC [2], [3], [4]. In contrast to public mobile radio networks, you can individually define the radio parameters during such tests and repeat the test any time under reproducible

► conditions. At an earlier development stage, it might still be useful to check the functionality of the mobile phone – without radiocommunications aspects – prior to migrating the PoC client software from the PC to the mobile phone. In this case, the Rohde&Schwarz PoC server provides its services to a PoC client that is installed on a laptop, for example. The PoC communications service then runs on two connected laptops without using a mobile phone.

### Future prospects

With the R&S®CRTU-ATE application test environment software platform, the Rohde&Schwarz test solution portfolio in digital mobile radio ranges from the physical layer up to the application layer. Besides the development and availability of new multimedia applications, additional test solutions will follow on this basis.

Thomas A. Kneidel

More information and data sheet at  
[www.rohde-schwarz.com](http://www.rohde-schwarz.com)  
 (search term: PoC)

#### REFERENCE

- [1] R&S®CRTU-W / -G: MMS tests on multimedia mobile phones. News from Rohde&Schwarz (2005) No. 185, pp 4–6.
- [2] R&S®CMU200: Test of CDMA2000® data applications. News from Rohde&Schwarz (2004) No. 182, pp 11–13
- [3] R&S®CMU200: Versatile application tests in (E)GPRS mobile radio. News from Rohde&Schwarz (2004) No. 184, pp 10–13
- [4] CMU goes Internet: Testing data applications for WCDMA. News from Rohde&Schwarz (2005) No. 186, pp 10–13

**With the new Bluetooth® standard V2.0 + EDR (enhanced data rate), you can use I/Q modulation methods for Bluetooth® packets. For the RF Testers R&S®CBT and R&S®CBT32, Rohde&Schwarz now offers an option to carry out transmitter and receiver measurements on EDR Bluetooth® devices and modules. The option supports the loopback test mode and, owing to the very high measurement speed, yields a high throughput in production.**

### Bluetooth® RF Testers R&S®CBT / R&S®CBT32

## Transmitter and receiver measurements for Bluetooth® V2.0 + EDR

### New comprehensive measurement requirements

The new Bluetooth® standard V2.0+EDR (see box on page 18) offers a data transmission rate up to three times as high as that of the previous standards V1.1 and V1.2. The higher data rate is obtained through  $\pi/4$ -DQPSK or 8DPSK I/Q modulation for the payload of Bluetooth® packets. The header of an EDR Bluetooth® packet continues to be GFSK-modulated. Using two modulation methods within one Bluetooth® packet is a real challenge for RF design engineers and calls for flexible and versatile measuring instruments. The production lines for Bluetooth® modules or devices now require measuring instruments that, in addition to previous tests, are also able

to measure the relevant EDR parameters in next to no time. The Bluetooth® RF Testers R&S®CBT and R&S®CBT32 (in short R&S®CBT) in combination with the new EDR option are ideal for meeting these requirements.

### Measuring the new EDR RF test cases

The Bluetooth® RF test specifications V1.2 / 2.0 / 2.0 + EDR comprise a total of eight new test cases for measurements with EDR Bluetooth® packets:

#### Transmitter measurements

- ◆ TRM/CA/10/C (EDR relative transmit power)



- ◆ TRM/CA/11/C (EDR carrier frequency stability and modulation accuracy)
- ◆ TRM/CA/12/C (EDR differential phase encoding)
- ◆ TRM/CA/13/C (EDR inband spurious emissions)

### Receiver measurements

- ◆ RCV/CA/07/C (EDR sensitivity)
- ◆ RCV/CA/08/C (EDR BER floor performance)
- ◆ RCV/CA/09/C (EDR C/I performance)
- ◆ RCV/CA/10/C (EDR maximum input level)

The R&S®CBT with EDR option can evaluate seven of these new test cases. An additional external signal generator is required for measuring the C/I performance.

### New EDR transmitter measurements

To carry out the four new EDR transmitter measurements, the R&S®CBT with EDR option offers four additional measurement menus that directly display the results stipulated by the RF test specification:

#### Relative transmit power

Evaluates the power difference between the GFSK portion and the DPSK portion of an EDR packet. The power difference must be within a certain tolerance range (FIG 1).

#### Carrier frequency stability and modulation accuracy

Measures the frequency accuracy within the packet header and the frequency drift within the DPSK-modulated payload, and calculates various DEVM results (DEVM = delta error vector magnitude). The R&S®CBT displays the current DEVM results versus time as a graph with the high updating rate known from the base unit (FIG 2). You can perform all measurements on individual frequencies or in the frequency

hopping mode and thus quickly find RF channels with a critical DUT behavior in the laboratory. Since the EDR packets use differential PSK modulation methods, only differential EVM measurements provide information on signal quality. EVM measurement results or the I/Q constellation diagram are not enough to assess signal quality.

#### Differential phase encoding

Tests the EDR encoder in the DUT. The R&S®CBT performs a BER measurement in the TX test mode. The DUT sends packets with a defined PRBS9 bit pattern, and the R&S®CBT compares the received bits with the expected ones. 99% of the received packets must be free of bit errors.

#### Inband spurious emissions

Adjacent channel power measurement (ACP) that only evaluates the DPSK portion of a Bluetooth® EDR packet. The menu in the R&S®CBT used for this measurement corresponds to the ACP measurement menu of the R&S®CBT base unit.

FIG 1 Relative power measurement of GFSK and DPSK portions of an EDR Bluetooth® packet.

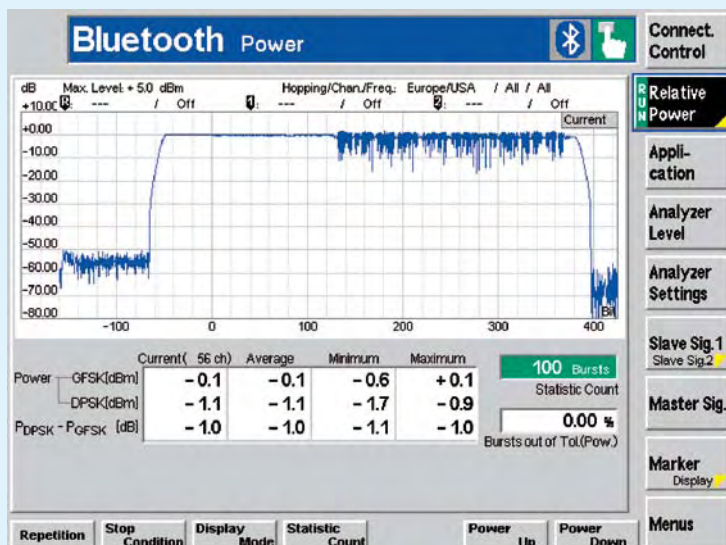
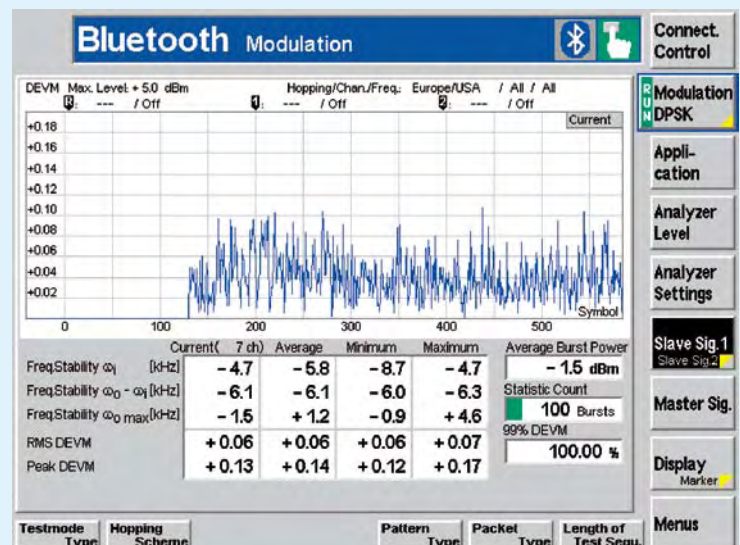

FIG 2 Graphical display of the DEVM characteristic within the payload of an EDR Bluetooth® packet.



## The new Bluetooth® standard V2.0 + EDR at a glance

The new Bluetooth® standard distinguishes between basic rate and enhanced data rate packets. Basic rate packets are already known from the standards V1.1 and V1.2. The additional EDR packets use the same packet header as basic rate packets (GFSK modulation) but transmit the payload by using DPSK modulation ( $\pi/4$ -DQPSK or 8DPSK). The Bluetooth® transmitter must therefore be able to switch over from GFSK to DPSK modulation within 5  $\mu$ s.

The DPSK modulation of the EDR packets yields a data transmission rate that is up to three times as high as that of basic rate packets. The Bluetooth® technology thus opens up new applications,

e.g. the uncompressed transmission of CD audio signals. When EDR packets are used for all applications that do not require higher data rates, smaller packet

lengths are obtained. The power consumption is thus reduced, which is particularly important for battery-powered devices (e.g. Bluetooth® headsets).

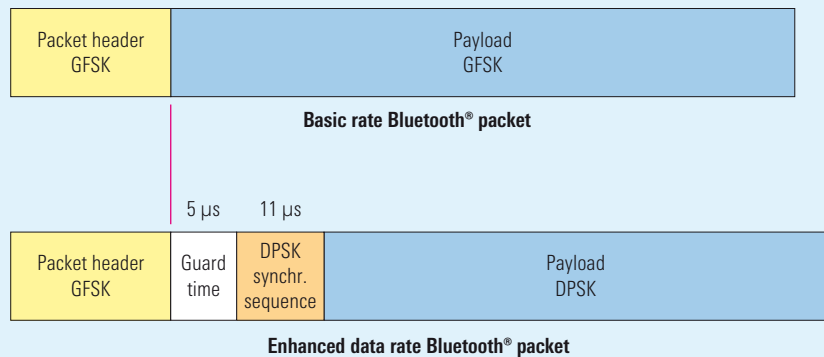

- ▶ The R&S®CBT performs all EDR transmitter measurements with the very high measurement speed already known from the base unit. This not only allows fast working in the laboratory but is also particularly beneficial in production, since the testing time (and thus the costs for testing) can be reduced to a minimum.

### Loopback test mode for EDR receiver measurements

To carry out the new EDR receiver measurements, the R&S®CBT supports the loopback test mode in accordance with Bluetooth® specification V2.0 + EDR. Proprietary solutions of the various chip manufacturers are no longer needed to evaluate the receiver sensitivity. The BER measurement menu of the R&S®CBT known from the base unit additionally allows you to set the new EDR packet types in combination with the EDR option. Moreover, the R&S®CBT

also includes the new dirty transmitter for EDR packets in accordance with the Bluetooth® RF test specification and offers various setting options for the different parameters of the dirty transmitter. This is particularly beneficial for laboratory tests.

### R&S®CBTGo supports work in the laboratory

R&S®CBTGo is PC application software allowing remote control of the R&S®CBT and R&S®CBT32. You can thus very easily configure any desired test sequence. Running a test sequence generates a test report that can be stored or whose results can be processed in a spreadsheet. R&S®CBTGo supports the Bluetooth® test cases that can be performed with the R&S®CBT and additionally offers further interesting features for working in the laboratory. The software can, for example, automatically

evaluate the measurement results of all Bluetooth® channels and can graphically display their characteristic in a test report. R&S®CBTGo can be downloaded free of charge from the Rohde&Schwarz website.

Dieter Mahnken

More information and data sheet at  
[www.rohde-schwarz.com](http://www.rohde-schwarz.com)  
 (search term: CBT or CBTGo)

## Vector Signal Generator R&amp;S®SMU200A

# Signals for testing multicarrier power amplifiers

Featuring excellent ACLR values, an RF bandwidth of 80 MHz and a high output level, the Vector Signal Generator R&S®SMU200A is an unrivaled multicarrier signal source.

The R&S®SMx signal generator family has another innovation in store – an option for generating GPS signals (page 36).

## New trend: multicarrier base stations

The growing number of voice and data services plus new standards such as 3GPP FDD or CDMA2000® led to a dense occupation of available frequency resources – compared with the initial phase of mobile radio.

Due to technical and cost-saving reasons the number of single-carrier base stations is limited. Hence, multicarrier base stations with only one power amplifier must accommodate several frequency channels. The linearity and intermodulation requirements placed on these amplifiers are very high, especially for 3GPP FDD or CDMA2000®.

The well-known multicarrier continuous wave option of the Vector Signal Generator R&S®SMU200A allows you to generate a multicarrier CW signal with user-definable carrier spacing and maximally 8192 unmodulated carriers. Now, the new multicarrier feature enables you to configure modulated carrier signals as well. A powerful yet easy-to-operate menu provides a multicarrier signal with up to 32 carriers and 80 MHz bandwidth. Using this signal, you can perform various transmitter and receiver tests specifically tailored to multicarrier transmission (e.g. in accordance with 3GPP TS.25.141).

## Complex signals – easy handling

First, the number of carriers and the carrier spacing are set in the main setting menu (FIG 1). The result is a multicarrier signal where the single carriers are arranged symmetrically around the RF frequency; the spacing between the carriers is equal.

Using the Crest Factor mode, you can choose between defining the phase angles of the individual carriers yourself and keeping the crest factor to a maximum or minimum by using the generator's optimization capability. Since the crest factor of a signal indicates the ratio between peak and rms voltage, a higher crest factor, for example, induces larger dynamic variations in the signal and, with transmitter tests, places stricter requirements on a power amplifier's linearity.

By calling the Carrier Table submenu, each carrier can now be configured individually with respect to phase, gain, delay and signal content. This configuration is clearly listed in a channel table. A wizard integrated in the menu ensures fast and easy settings since phase, gain, delay and signal content need not be individually entered in the channel table but can be set globally by specifying the start value and the step size (FIG 2).

To verify the settings, the Multicarrier menu also provides a symbolic representation of the set scenario (FIG 3) in accordance with the channel table in the frequency range, as would be visualized on a spectrum analyzer (FIG 4). In this example, four 3GPP FDD test signals are centered around the RF frequency, each

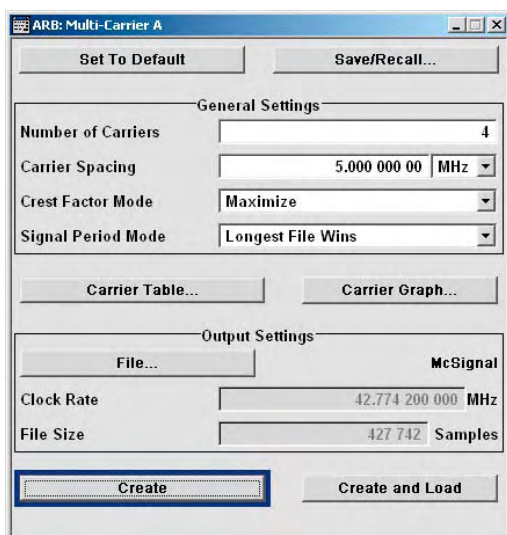
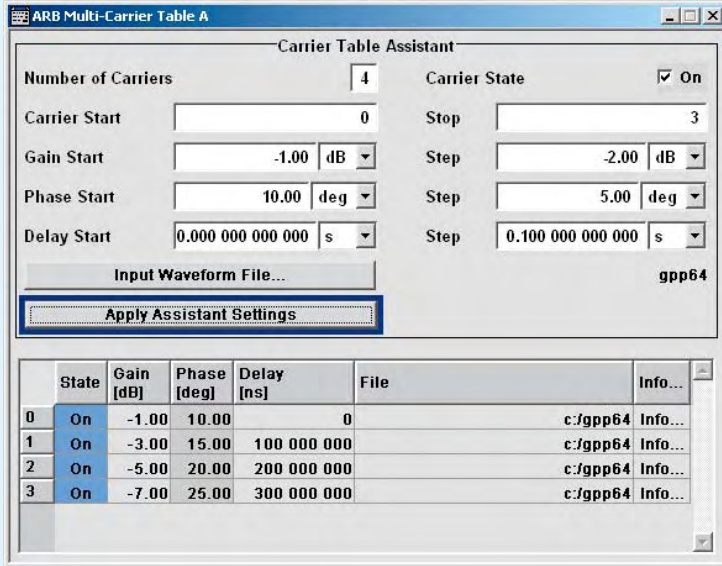

FIG 1 Main setting menu for generating multicarrier signals.



**FIG 2**  
The Carrier Table Assistant submenu and the channel table derived from it.

▶ attenuated by 2 dB relative to the others. The result of 68 dB for ACLR is far better than the 50 dB limit specified by 3GPP in TS25.141 for spurious emissions.

Owing to the high level accuracy of internal signal processing in the R&S®SMU200A, the level differences of the individual carriers with regard to each other may be 30 dB to 40 dB at an acceptable error vector magnitude (EVM), if required by the test scenario. The delay of the carrier signals with respect to each other can be set to 1 ns exactly. In the TS25.141, for example, the downlink test models of the 3GPP standards specify that the individual carriers, each shifted by one fifth of a time-slot duration, be added together.

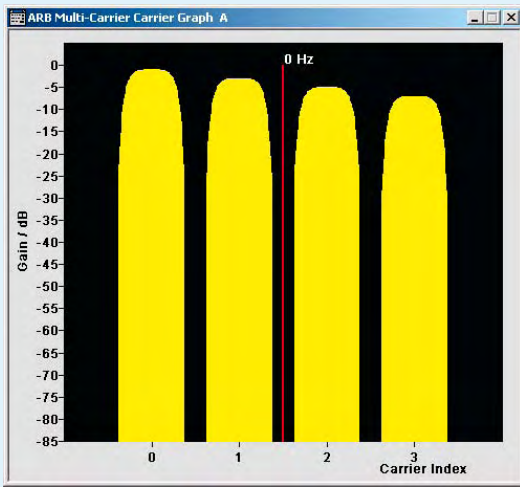

**FIG 3**  
Visualized channel table: four 3GPP test signals, each with a level difference of 2 dB relative to the others.

**New: interface for waveform files**

All internally or externally generated waveform files can be used as input signal sources for the individual carriers. The R&S WinIQSIM™ Windows® software, for example, allows you to generate various waveforms yourself or import signals from other mathematical programs such as MATLAB® using R&S IQWizard™ [\*]. Data can be loaded to the generator via the USB or IEC/IEEE bus interface.

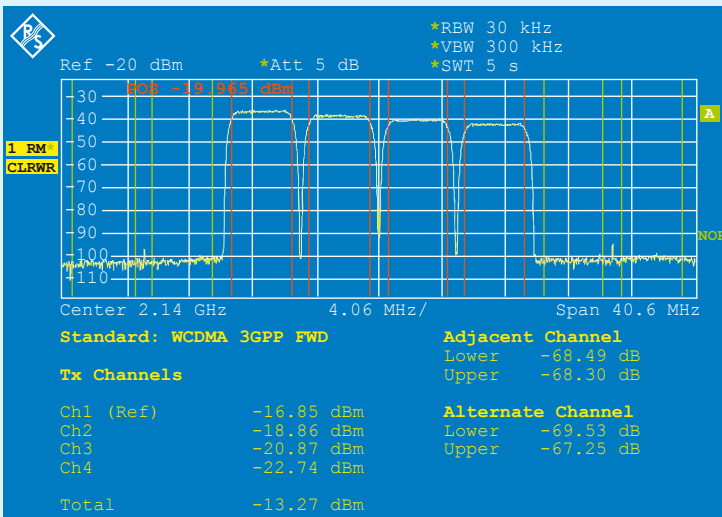

**FIG 4**  
As a result, the multicarrier signal is made up of four 3GPP signals (test model 1) that are arranged on adjacent carriers at 5 MHz spacing.

What's new is that the software modules integrated in the R&S®SMU200A can now also generate waveform files for the 3GPP FDD and CDMA2000® standards; these files already include a completely modulated, i.e. pulse-shaped, waveform (FIG 5 top, Generate Waveform File). These files can be directly entered on the Multicarrier list as the input data sources. Thus, a single signal generator can generate a user-configurable multicarrier test signal for these standards without requiring further devices or external PCs.

The example in FIG 5 shows how easy it is to generate a multistandard multicarrier signal: By clicking *Generate Waveform File*, two waveform files are generated via the 3GPP FDD menu, containing a test model 1 (64 DPCHs and 32 DPCHs, respectively); a separate base station test signal is stored by the CDMA2000® menu. These three files are now entered in the channel table of the Multicarrier menu and provided as a multicarrier signal at the generator RF output.

## Summary

By providing the new Multicarrier menu and a waveform file interface integrated in the software modules for the digital 3GPP FDD and CDMA2000® standards, the Vector Signal Generator R&S®SMU 200A offers various ways to generate adequate multicarrier test signals. With its outstanding RF characteristics, the R&S®SMU 200A is virtually indispensable for the new development of future multicarrier base stations and their broadband power amplifiers.

Dr Karlheinz Pensel

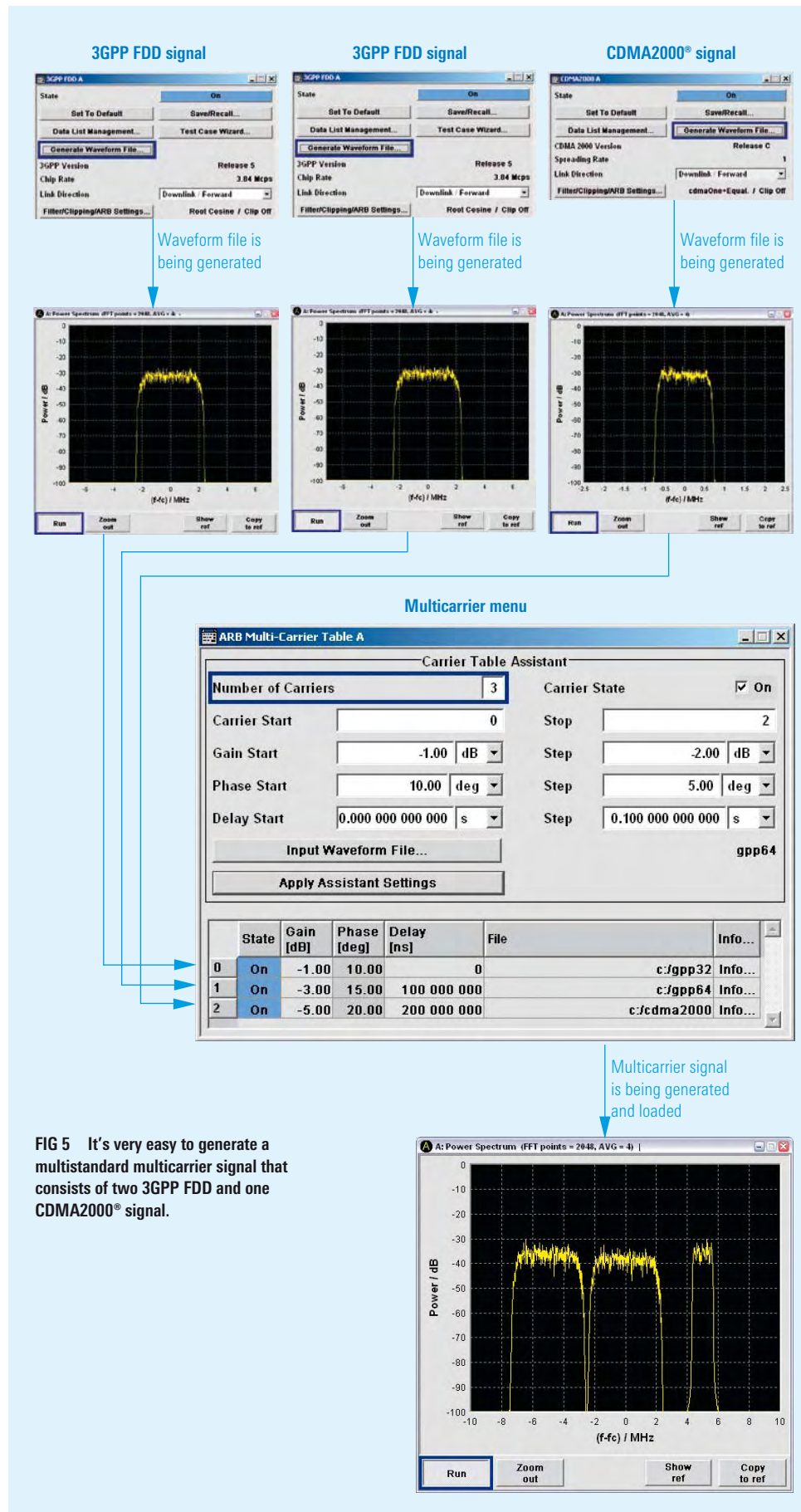

FIG 5 It's very easy to generate a multistandard multicarrier signal that consists of two 3GPP FDD and one CDMA2000® signal.

More information and data sheet at [www.rohde-schwarz.com](http://www.rohde-schwarz.com) (search term: SMU200)

[\*] R&S IQWizard™: I/Q signal measurement & conversion. Technical Information from Rohde & Schwarz (search term: 1MA28).



44 452/5

**FIG 1** The new WLAN Protocol Tester R&S®PTW 70 provides all required conformance test functions. But that's not all it can do.

## WLAN Protocol Tester R&S®PTW 70

# Multimode protocol analysis in WLANs

**You can find IEEE 802.11-based WLANs in all types of environments: in wireless home networks but also in company and campus networks or in giant hotspots for providing coverage for complete cities. As a result, the requirements placed on protocol testers are quite complex and demanding.**

### Designed for high performance

At first glance, the R&S®PTW 70 is quite simple in design (FIG 1). The tester does not even have a display since one would be of little use for graphically displaying the results of complex protocol analysis anyway. The actual strength of the new protocol tester is its convenient and extremely powerful control software which can be installed on any PC running on Windows®. The link between the controller and the protocol tester is established via a LAN. This concept is ideal since it allows the highly versatile use of the protocol tester via remote control.

### From a classic protocol tester to a general-purpose instrument

The main task of a protocol tester is to check DUTs for compliance with standard specifications (conformance tests). To ensure a uniform test procedure covering all relevant scenarios, the standardization bodies usually specify protocol conformance tests. This is mostly done in the TTCN language (TTCN = tree and tabular combined notation), which was specially developed for this purpose and is used, for example, for the 3G standards and Bluetooth®.

The IEEE 802.11a/b/g standards, however, do not use this language. Instead, golden device tests are defined to ensure interoperability. During these tests, a DUT is checked for correct operation in conjunction with several other reference units.

The drawbacks of this indeed very pragmatic approach soon become evident. The selected reference units have a significant influence on the result. A possible malfunction does not give many clues to the actual source of error since it could have also been caused by one of the reference units. Many scenarios cannot even be tested with this method. There are no invalid behavior tests at all. During these tests, the response of the DUT to malfunctions of the counterpart is examined more closely.

The Protocol Tester R&S®PTW 70 of course provides all conformance test functions. But Rohde&Schwarz is known for offering devices that far exceed standard requirements: A classic protocol tester would probably not be accepted in this difficult market. The new protocol tester was meant to go far beyond these standard requirements. In addition to the defined test cases, it was supposed to be flexible enough to handle a wide variety of tasks in non-conformance testing. This included not only multimode capabilities, but also the capability to adapt the test sequence as quickly as possible and without any special knowledge of the TTCN language, for example. The R&S®PTW 70 meets these demanding requirements.

### Multimode capability – versatility required

Multimode capability means that all important associated standards and extensions are supported by the R&S®PTW 70. This includes IEEE 802.11a/b/g in the ISM and

U-NII bands but also the Japan band. The protocol tester can be operated as an access point and station. Switchover is dynamic, i.e. the stack is not reloaded.

The R&S®PTW 70 has two main operating modes: the monitor mode for passive communication sniffing on the air interface and the active mode for triggering the communication stack. You can run the protocol tester in both modes at the same time. This allows direct control at any layer (LLC, MAC, PHY). These characteristics make the R&S®PTW 70 ideal for a variety of applications, e.g. retransmission tests, invalid behavior tests and stress tests.

The R&S®PTW 70 offers calibrated level measurements, a settable output level (–30 dBm to +10 dBm) and packet error ratio measurements. The high time resolution of 50 ns for recording protocol messages makes detailed problem analysis easy. You can send IP payload files through the protocol tester directly via the network interface.

### Simple operation despite maximum flexibility

Even setting up a small WLAN home network can present problems, because so many parameters have to be defined. Imagine how complex a user interface for a protocol tester must be where practically every parameter down to the individual bits of a layer-1 message can be modified. Rohde&Schwarz solved this problem by using a hierarchical script user interface (FIG 2).

In the R&S®PTW 70, scripts are not edited in text form but are created by means of a special graphical user interface. The structure is deliberately kept simple: You can program whatever you want without having to know a script language or higher programming language. Even so, this graphical user interface contains very complex functions, i.e. the timeout-controlled reception of messages, the evaluation of individual message fields and the generation of report files.

### The IEEE 802.11 standard

IEEE 802.11 is an IEEE-specified family of standards for WLANs. The 802.11a/b/g standards are widely used. The 11b and 11g standards operate in the license-free ISM band at 2.4 GHz, 11a in the U-NII band at 5 GHz. The 11b standard uses DSSS modulation, whereas 11a and 11g operate with OFDM and 52 subcarriers that are modulated with BPSK, QPSK, 16QAM or 64QAM depending on the data rate. The 11g standard is backward-compatible with 11b. The 11b standard allows gross data rates up to 11 Mbit/s, 11a and 11g up to 54 Mbit/s.

Numerous expansions are available, e.g. 11e (quality of service enhancements) and 11i (security enhancements). Especially 11i uses encryption technologies other than WEP, which was originally used and was less safe.

Interestingly, the very similar European ETSI standard HiperLAN/2 basically specifies many of the subsequent 802.11 expansions. However, HiperLAN/2 could not match the 802.11 standard, which was promoted much faster.

- ▶ Scripts run directly on the protocol tester and are therefore independent of the network connection or the load on the controller. A script is downloaded to the protocol tester and then compiled so quickly that you may think that the script was executed immediately. Together with the convenient test step editor, scripts can thus be modified and executed again within seconds.

### Uncompromising online data analysis

The message analyzer (FIG 3) supports detailed evaluation of protocol messages. The R&S®PTW 70 has uncompromisingly been designed for online analysis and high performance. While log messages are being recorded, you can navigate through all received messages and display their hierarchical structure in a separate window in fully decoded form. You can open multiple analysis windows with different software filters.

Internal data retention is so powerful that a very large volume of messages can be managed without any loss in performance. There is also no concern about a limited data buffer, a drawback quite common in other systems.

In addition to software filters, the protocol tester also contains hardware filters for adapting the primary message stream. These hardware filters can handle layer-1 messages as standard, for example.

You can store the messages in files and reload them for offline analysis. A script command can also be used to trigger the storage of messages. This is useful with automatic test sequences, for example, when you want to store message logs generated due to errors for later troubleshooting.

### Full remote control also possible

The script interface can be remote-controlled via TCP/IP. By sending the script name and the parameters as ASCII text, the corresponding script will be loaded and immediately executed. Execution confirmation and return parameters or error messages will be returned. Any script created by the user, including parameterization, will immediately be available via the remote-control interface. Remote-control is thus dynamically expanded.

The TCP service port can be selected as needed and transferred as a start parameter. Since practically any script and programming language supports TCP/IP, you can easily integrate the R&S®PTW 70 into automatic systems without any special knowledge required.

### Future prospects

Further interesting applications will be opened up for WLAN in the future, e.g. unlicensed mobile access (UMA), an initiative to expand mobile radio services in license-free bands via 802.11, for example. Thus, mobile phones will also transmit voice and data services economically via WLAN and be able to handle hand-over between the WLAN and the corresponding mobile radio network. The universal concept of the WLAN Protocol Tester R&S®PTW 70 readily enables the instrument to meet these new application requirements. And with 802.16, which is also known as WiMAX and is based on the OFDM transmission method, the next promising standard is already on its marks.

Frank Rieder

FIG 2 ▶

**Hierarchical script user interface:** Test sets combine scripts offering typical functionality and can be loaded dynamically. A test can be loaded and, if required, immediately executed merely by pressing a button. If the high-level script has parameters that are not predefined, the script will prompt you to enter them when it is started. High-level scripts mainly consist of calls of supplied or self-generated subscripts. You can understand them with only minor knowledge of the protocol. Low-level scripts consist of message definitions and instructions to send, receive and evaluate messages. Messages from and to service access points of the stack can be understood only if you have detailed knowledge of the protocol. Scripts of all levels generally have the same format. The logical functional structure helps different user groups to get quickly started.

FIG 3 ▶  
Message analyzer

More information and data sheet at  
[www.rohde-schwarz.com](http://www.rohde-schwarz.com)  
(search term: PTW70)

WLAN Protocol Tester R&S®PTW 70  
802.11, 802.16, 802.11n, 802.11g, 802.11b, 802.11a, 802.11m, 802.11r, 802.11s, 802.11t, 802.11u, 802.11v, 802.11w, 802.11y, 802.11z, 802.11aa, 802.11ab, 802.11ac, 802.11ad, 802.11ah, 802.11ai, 802.11aj, 802.11ak, 802.11al, 802.11am, 802.11an, 802.11ao, 802.11ap, 802.11aq, 802.11ar, 802.11as, 802.11at, 802.11au, 802.11av, 802.11aw, 802.11ax, 802.11ay, 802.11az, 802.11ba, 802.11bb, 802.11bc, 802.11bd, 802.11be, 802.11bf, 802.11bg, 802.11bh, 802.11bi, 802.11bj, 802.11bk, 802.11bl, 802.11bm, 802.11bn, 802.11bo, 802.11bp, 802.11bq, 802.11br, 802.11bs, 802.11bt, 802.11bu, 802.11bv, 802.11bw, 802.11bx, 802.11by, 802.11bz, 802.11ca, 802.11cb, 802.11cc, 802.11cd, 802.11ce, 802.11cf, 802.11cg, 802.11ch, 802.11ci, 802.11cj, 802.11ck, 802.11cl, 802.11cm, 802.11cn, 802.11co, 802.11cp, 802.11cq, 802.11cr, 802.11cs, 802.11ct, 802.11cu, 802.11cv, 802.11cw, 802.11cx, 802.11cy, 802.11cz, 802.11da, 802.11db, 802.11dc, 802.11dd, 802.11de, 802.11df, 802.11dg, 802.11dh, 802.11di, 802.11dj, 802.11dk, 802.11dl, 802.11dm, 802.11dn, 802.11do, 802.11dp, 802.11dq, 802.11dr, 802.11ds, 802.11dt, 802.11du, 802.11dv, 802.11dw, 802.11dx, 802.11dy, 802.11dz, 802.11ea, 802.11eb, 802.11ec, 802.11ed, 802.11ee, 802.11ef, 802.11eg, 802.11eh, 802.11ei, 802.11ej, 802.11ek, 802.11el, 802.11em, 802.11en, 802.11eo, 802.11ep, 802.11eq, 802.11er, 802.11es, 802.11et, 802.11eu, 802.11ev, 802.11ew, 802.11ex, 802.11ey, 802.11ez, 802.11fa, 802.11fb, 802.11fc, 802.11fd, 802.11fe, 802.11ff, 802.11fg, 802.11fh, 802.11fi, 802.11fj, 802.11fk, 802.11fl, 802.11fm, 802.11fn, 802.11fo, 802.11fp, 802.11fq, 802.11fr, 802.11fs, 802.11ft, 802.11fu, 802.11fv, 802.11fw, 802.11fx, 802.11fy, 802.11fz, 802.11ga, 802.11gb, 802.11gc, 802.11gd, 802.11ge, 802.11gf, 802.11gg, 802.11gh, 802.11gi, 802.11gj, 802.11gk, 802.11gl, 802.11gm, 802.11gn, 802.11go, 802.11gp, 802.11gq, 802.11gr, 802.11gs, 802.11gt, 802.11gu, 802.11gv, 802.11gw, 802.11gx, 802.11gy, 802.11gz, 802.11ha, 802.11hb, 802.11hc, 802.11hd, 802.11he, 802.11hf, 802.11hg, 802.11hh, 802.11hi, 802.11hj, 802.11hk, 802.11hl, 802.11hm, 802.11hn, 802.11ho, 802.11hp, 802.11hq, 802.11hr, 802.11hs, 802.11ht, 802.11hu, 802.11hv, 802.11hw, 802.11hx, 802.11hy, 802.11hz, 802.11ia, 802.11ib, 802.11ic, 802.11id, 802.11ie, 802.11if, 802.11ig, 802.11ih, 802.11ii, 802.11ij, 802.11ik, 802.11il, 802.11im, 802.11in, 802.11io, 802.11ip, 802.11iq, 802.11ir, 802.11is, 802.11it, 802.11iu, 802.11iv, 802.11iw, 802.11ix, 802.11iy, 802.11iz, 802.11ja, 802.11jb, 802.11jc, 802.11jd, 802.11je, 802.11jf, 802.11jg, 802.11jh, 802.11ji, 802.11jj, 802.11jk, 802.11jl, 802.11jm, 802.11jn, 802.11jo, 802.11jp, 802.11jq, 802.11jr, 802.11js, 802.11jt, 802.11ju, 802.11jv, 802.11jw, 802.11jx, 802.11jy, 802.11jz, 802.11ka, 802.11kb, 802.11kc, 802.11kd, 802.11ke, 802.11kf, 802.11kg, 802.11kh, 802.11ki, 802.11kj, 802.11kk, 802.11kl, 802.11km, 802.11kn, 802.11ko, 802.11kp, 802.11kq, 802.11kr, 802.11ks, 802.11kt, 802.11ku, 802.11kv, 802.11kw, 802.11kx, 802.11ky, 802.11kz, 802.11la, 802.11lb, 802.11lc, 802.11ld, 802.11le, 802.11lf, 802.11lg, 802.11lh, 802.11li, 802.11lj, 802.11lk, 802.11ll, 802.11lm, 802.11ln, 802.11lo, 802.11lp, 802.11lq, 802.11lr, 802.11ls, 802.11lt, 802.11lu, 802.11lv, 802.11lw, 802.11lx, 802.11ly, 802.11lz, 802.11ma, 802.11mb, 802.11mc, 802.11md, 802.11me, 802.11mf, 802.11mg, 802.11mh, 802.11mi, 802.11mj, 802.11mk, 802.11ml, 802.11mm, 802.11mn, 802.11mo, 802.11mp, 802.11mq, 802.11mr, 802.11ms, 802.11mt, 802.11mu, 802.11mv, 802.11mw, 802.11mx, 802.11my, 802.11mz, 802.11na, 802.11nb, 802.11nc, 802.11nd, 802.11ne, 802.11nf, 802.11ng, 802.11nh, 802.11ni, 802.11nj, 802.11nk, 802.11nl, 802.11nm, 802.11nn, 802.11no, 802.11np, 802.11nq, 802.11nr, 802.11ns, 802.11nt, 802.11nu, 802.11nv, 802.11nw, 802.11nx, 802.11ny, 802.11nz, 802.11oa, 802.11ob, 802.11oc, 802.11od, 802.11oe, 802.11of, 802.11og, 802.11oh, 802.11oi, 802.11oj, 802.11ok, 802.11ol, 802.11om, 802.11on, 802.11oo, 802.11op, 802.11oq, 802.11or, 802.11os, 802.11ot, 802.11ou, 802.11ov, 802.11ow, 802.11ox, 802.11oy, 802.11oz, 802.11pa, 802.11pb, 802.11pc, 802.11pd, 802.11pe, 802.11pf, 802.11pg, 802.11ph, 802.11pi, 802.11pj, 802.11pk, 802.11pl, 802.11pm, 802.11pn, 802.11po, 802.11pp, 802.11pq, 802.11pr, 802.11ps, 802.11pt, 802.11pu, 802.11pv, 802.11pw, 802.11px, 802.11py, 802.11pz, 802.11qa, 802.11qb, 802.11qc, 802.11qd, 802.11qe, 802.11qf, 802.11qg, 802.11qh, 802.11qi, 802.11qj, 802.11qk, 802.11ql, 802.11qm, 802.11qn, 802.11qo, 802.11qp, 802.11qq, 802.11qr, 802.11qs, 802.11qt, 802.11qu, 802.11qv, 802.11qw, 802.11qx, 802.11qy, 802.11qz, 802.11ra, 802.11rb, 802.11rc, 802.11rd, 802.11re, 802.11rf, 802.11rg, 802.11rh, 802.11ri, 802.11rj, 802.11rk, 802.11rl, 802.11rm, 802.11rn, 802.11ro, 802.11rp, 802.11rq, 802.11rr, 802.11rs, 802.11rt, 802.11ru, 802.11rv, 802.11rw, 802.11rx, 802.11ry, 802.11rz, 802.11sa, 802.11sb, 802.11sc, 802.11sd, 802.11se, 802.11sf, 802.11sg, 802.11sh, 802.11si, 802.11sj, 802.11sk, 802.11sl, 802.11sm, 802.11sn, 802.11so, 802.11sp, 802.11sq, 802.11sr, 802.11ss, 802.11st, 802.11su, 802.11sv, 802.11sw, 802.11sx, 802.11sy, 802.11sz, 802.11ta, 802.11tb, 802.11tc, 802.11td, 802.11te, 802.11tf, 802.11tg, 802.11th, 802.11ti, 802.11tj, 802.11tk, 802.11tl, 802.11tm, 802.11tn, 802.11to, 802.11tp, 802.11tq, 802.11tr, 802.11ts, 802.11tt, 802.11tu, 802.11tv, 802.11tw, 802.11tx, 802.11ty, 802.11tz, 802.11ua, 802.11ub, 802.11uc, 802.11ud, 802.11ue, 802.11uf, 802.11ug, 802.11uh, 802.11ui, 802.11uj, 802.11uk, 802.11ul, 802.11um, 802.11un, 802.11uo, 802.11up, 802.11uq, 802.11ur, 802.11us, 802.11ut, 802.11uu, 802.11uv, 802.11uw, 802.11ux, 802.11uy, 802.11uz, 802.11va, 802.11vb, 802.11vc, 802.11vd, 802.11ve, 802.11vf, 802.11vg, 802.11vh, 802.11vi, 802.11vj, 802.11vk, 802.11vl, 802.11vm, 802.11vn, 802.11vo, 802.11vp, 802.11vq, 802.11vr, 802.11vs, 802.11vt, 802.11vu, 802.11vv, 802.11vw, 802.11vx, 802.11vy, 802.11vz, 802.11wa, 802.11wb, 802.11wc, 802.11wd, 802.11we, 802.11wf, 802.11wg, 802.11wh, 802.11wi, 802.11wj, 802.11wk, 802.11wl, 802.11wm, 802.11wn, 802.11wo, 802.11wp, 802.11wq, 802.11wr, 802.11ws, 802.11wt, 802.11wu, 802.11wv, 802.11ww, 802.11wx, 802.11wy, 802.11wz, 802.11xa, 802.11xb, 802.11xc, 802.11xd, 802.11xe, 802.11xf, 802.11xg, 802.11xh, 802.11xi, 802.11xj, 802.11xk, 802.11xl, 802.11xm, 802.11xn, 802.11xo, 802.11xp, 802.11xq, 802.11xr, 802.11xs, 802.11xt, 802.11xu, 802.11xv, 802.11xw, 802.11xx, 802.11xy, 802.11xz, 802.11ya, 802.11yb, 802.11yc, 802.11yd, 802.11ye, 802.11yf, 802.11yg, 802.11yh, 802.11yi, 802.11yj, 802.11yk, 802.11yl, 802.11ym, 802.11yn, 802.11yo, 802.11yp, 802.11yq, 802.11yr, 802.11ys, 802.11yt, 802.11yu, 802.11yv, 802.11yw, 802.11yx, 802.11yy, 802.11yz, 802.11za, 802.11zb, 802.11zc, 802.11zd, 802.11ze, 802.11zf, 802.11zg, 802.11zh, 802.11zi, 802.11zj, 802.11zk, 802.11zl, 802.11zm, 802.11zn, 802.11zo, 802.11zp, 802.11zq, 802.11zr, 802.11zs, 802.11zt, 802.11zu, 802.11zv, 802.11zw, 802.11zx, 802.11zy, 802.11zz



**Test set**      **Low-level scripts**      **High-level script**      **Test step editor**

The screenshot shows the PTW70 Script User Interface. On the left is a 'Test set' table with columns for step number, name, and duration. The center pane displays 'Low-level scripts' as a sequence of numbered steps (19-70) with corresponding script code. The right pane is the 'Test step editor', showing a hierarchical tree of test steps like 'Request', 'Type', 'Stack', and 'Mac Address' with various options and values.

**Analyzer window**      **Message sequence chart**      **Decoder window**      **Scan window**

The screenshot displays the PTW70 Analyzer 1 interface. The top pane is a table of captured messages with columns for Protocol, Message Type, Primitive, Type, SubType, Status, MACHeader, and Rate. Below this is a 'Message sequence chart' showing a timeline of messages between different components (MimeReq, Tx, Rx, Mpd). The right side features a 'Decoder window' showing the hierarchical structure of a selected message, including fields like 'Mm Indicate', 'Parameter', and 'DA'. At the bottom right is a 'Scan window' showing the raw hex and ASCII data of the selected message.

## Vector Network Analyzer R&amp;S®ZVA

# High-end network analyzer – future-proof and extremely fast

The new R&S®ZVA generation of high-end network analyzers offers high measurement speed, maximum dynamic range and extremely high versatility and accuracy – ideal prerequisites for present and future measurement tasks. On top of this, the user benefits from an easy and intuitive operating concept.

## Sophisticated hardware concept

The high end Network Analyzer R&S®ZVA (FIG 1) is available in two models up to 8 GHz and 24 GHz with two or four test ports each. Like the R&S®ZVR predecessor model, the R&S®ZVA employs the tried-and-tested fundamental mixing concept, which ensures maximum sensitivity and dynamic range. The analyzer features extremely fast synthesizers, which make for minimum measurement times. Each test port is equipped with a measurement receiver and a reference receiver, and a separate generator is provided for each pair

of test ports; the generator signals can be applied sequentially or in parallel as required (FIG 2). This enables parallel measurements on DUTs.

## Multitalent opening up unique opportunities for designers

### Unparalleled versatility ...

New technologies and increasingly shorter innovation cycles mean that designers in development labs are faced with continuously changing requirements. A scenario like this calls for highly versatile test equipment that can be used for a variety of DUTs. In this sce-

FIG 1 Superior RF performance combined with versatile use and extendability – these are essential characteristics of the Vector Network Analyzer R&S®ZVA.

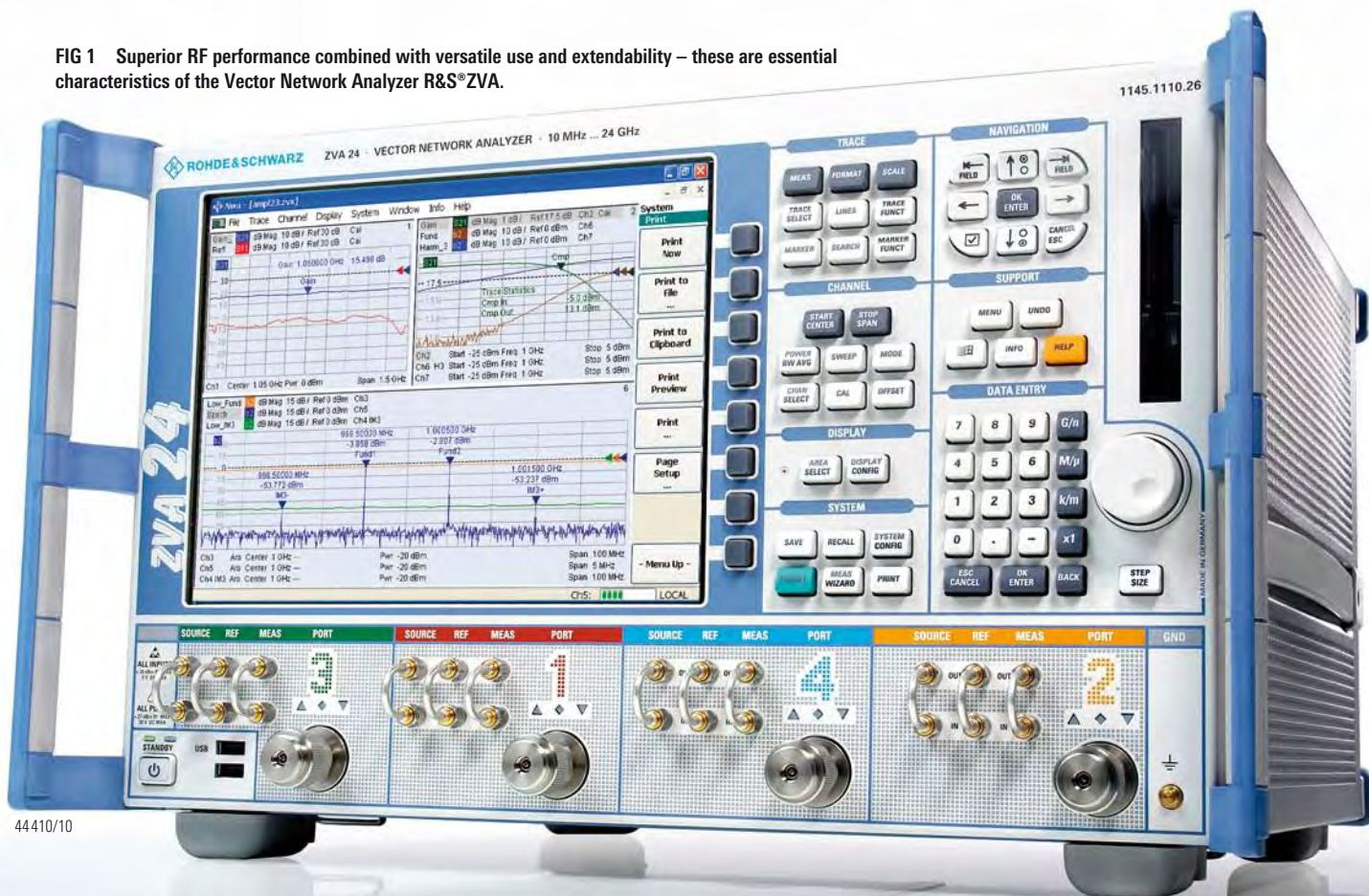

44410/10

nario, the R&S®ZVA proves to be a real multitalent: The basic version already provides measurements on balanced and unbalanced passive components as well as on amplifiers. Frequency-converting measurements on mixers and amplifiers as well as time domain measurements are provided optionally.

### ... combined with utmost convenience

The intuitive operating concept of the Network Analyzer R&S®ZVA does away with the tedious studying of a manual. For more complex settings as are required, for example, for measuring balanced or other multiports, a wizard is available that guides the user step by step through a desired setup and queries all necessary inputs. Even highly complex measurement settings can thus be made quickly and easily without any in-depth knowledge about the instrument (FIG 3).

## Typical applications

### Measurements on base station filters

Base station filters are characterized by very high attenuation in the stop-band and low attenuation in the pass-band. To perform  $S_{21}$  measurements on such filters, the instrument must have a wide dynamic range. Moreover, segmented sweeps have to be used, which allow parameter settings to be optimally matched to the passband and the stop-band (FIGs 4 and 5).

For the filter stopband, a narrow IF bandwidth (minimum 1 Hz) is set in order to achieve maximum sensitivity. The longer measurement time involved in this approach can be compensated by reducing the number of test points, thus providing a wide dynamic range at an acceptable speed.

In the passband, the main requirements are high resolution and low trace noise. A large number of test points is, there-

**FIG 2**  
Block diagram of four-port standard test set in the R&S®ZVA. Each test port is equipped with a measurement receiver and a reference receiver, and a separate generator is provided for each pair of test ports; the generator signals can be applied sequentially or in parallel as required.

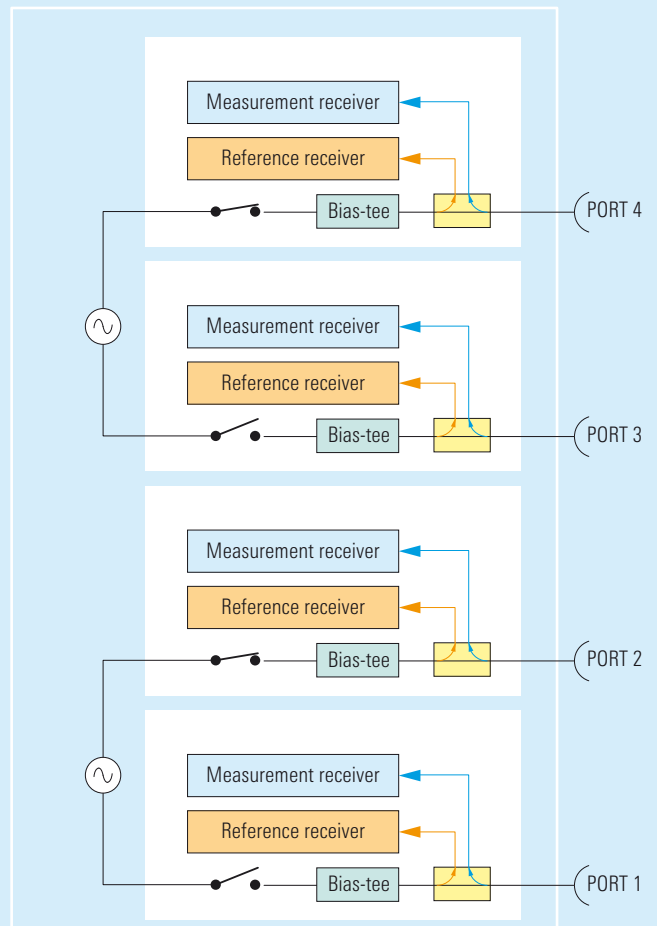

**FIG 3**  
Test settings made easy – even for complex measurements: The wizard provided in the R&S®ZVA guides the user step by step through the desired setup and queries all necessary inputs.

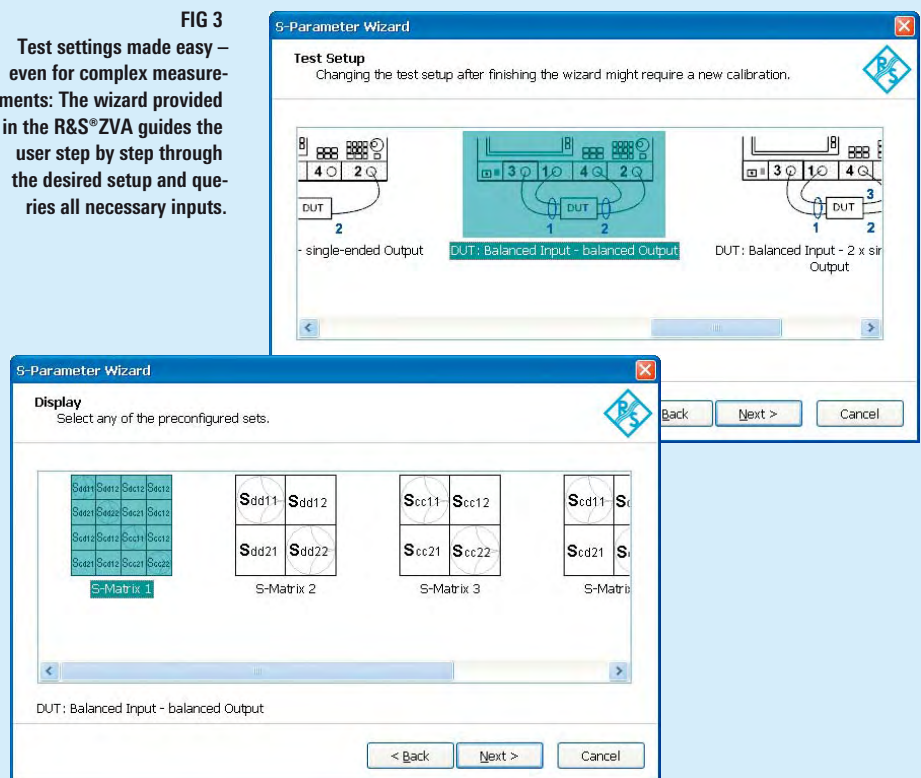

► fore, selected for this range in order to enable an accurate analysis of the filter ripple – which is the ratio of the maximum to the minimum power level in the passband. To prevent the receiver section of the analyzer from being overdriven because of the low filter attenuation, an output power of  $-10$  dBm is selected, for example (FIG 4).

### Characterization of amplifiers

The R&S®ZVA offers a wide range of amplifier measurements. To measure the transmission characteristics of an amplifier with high accuracy and without interruption, it is desirable to use the widest possible level range without having to switch any attenuators. Featuring electronic level switching over a range of typically 50 dB, the R&S®ZVA is ideally suited for measuring the transmission and compression characteristics of amplifiers (FIG 6).

Measuring the small signal behavior sometimes calls for extremely small levels. Optional mechanical attenuators are available to reduce the analyzer output level to  $<-100$  dBm. Measuring compression, by contrast, calls for output levels as high as possible; the R&S®ZVA offers  $+15$  dBm.

Measuring active DUTs requires DC voltage, which can be fed at the bias-tee inputs on the R&S®ZVA rear panel. The DC voltage is applied to the DUT via the analyzer's inner conductor. The DC inputs on the R&S®ZVA make it possible to measure the supply voltage or the current proportional to this voltage, from which the power added efficiency (PAE), i.e. the ratio of output minus input power to DC power of the amplifier, is determined.

To ensure highly accurate amplifier measurements, the analyzer's output power is calibrated, which also eliminates the effects of the test setup. This is done by means of an R&S®NRP power sen-

sor, which is connected to the R&S®ZVA and controlled via its USB interface. By means of this power sensor, the R&S®ZVA calibrates the generator versus level or frequency. Calibration can be carried out in iterative steps or down to a predefined minimum level tolerance.

### Intermodulation measurements on amplifiers

The R&S®ZVA four-port model comes with two internal generators. These can generate a two-tone signal, which is required for intermodulation measurements. An external generator is not needed (FIG 7). The low phase noise of the R&S®ZVA's internal generators and the very good power-handling capability of its receivers are optimum prerequisites for measuring high intercept points.

### Hot S-parameter measurements on power amplifiers

To characterize a power amplifier, its output matching ( $S_{22}$ ) must be measured under real conditions, i.e. under full load, which is known as hot S-parameter measurement. This is the only way to optimally match an amplifier to the load at its output. The problem encountered in this measurement is that the high output signal of the amplifier is superimposed on the signal generated by the analyzer at test port 2. The problem is solved by introducing a small frequency offset between the signal at the amplifier output and the signal generated by the analyzer for measuring  $S_{22}$ . This, however, requires very high receiver selectivity as well as robust level control – features which are of course provided by the R&S®ZVA.

### Frequency-converting measurements on mixers

The R&S®ZVA analyzer concept features independent synthesizers. This is necessary for performing measurements on mixers and frequency converters, as it allows the generators and receivers to sweep at different frequencies. The LO

signal for the mixer can be supplied by an external generator or by the second generator provided in the R&S®ZVA four-port model (FIG 8).

Intermodulation measurements on mixers can be performed using an external generator, which is controlled via the analyzer's LAN or IEC/IEEE bus interface. Mixers are mainly characterized by their conversion loss, matching, group delay, isolation, compression and intermodulation – the R&S®ZVA measures all these quantities and provides a straightforward overview of results (FIG 9).

### Optimized production sequences

The principal requirement in production is high throughput. Whether high production throughput can be achieved depends on the speed of the measuring instruments and, in automated sequences, on the time required for data transfer to the controller.

### Record holder in speed

The R&S®ZVA sets new standards in measurement speed since, due to its fast synthesizers, it requires less than 5 ms for a frequency sweep over 201 test points. In the CW sweep mode, a measurement time of less than  $3.5 \mu\text{s}$  per test point can be achieved. This makes the R&S®ZVA the fastest network analyzer currently available on the market.

To minimize measurement time, the IF bandwidth should be as large as possible. At the same time, dynamic range should not be unduly reduced and trace noise should be kept to a minimum. The R&S®ZVA's is optimally suited for this as it features an excellent dynamic range of typically 135 dB between test ports, which is extended up to 150 dB with direct receiver access (option), and trace noise as low as typically 0.0008 dB at an IF bandwidth of 1 kHz. ►

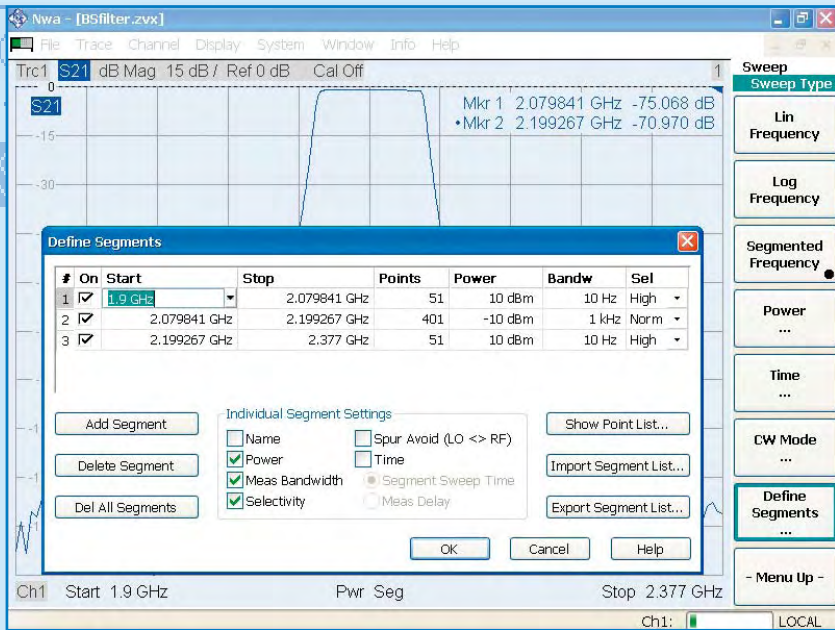

FIG 4 Settings for measurements on a base station filter.

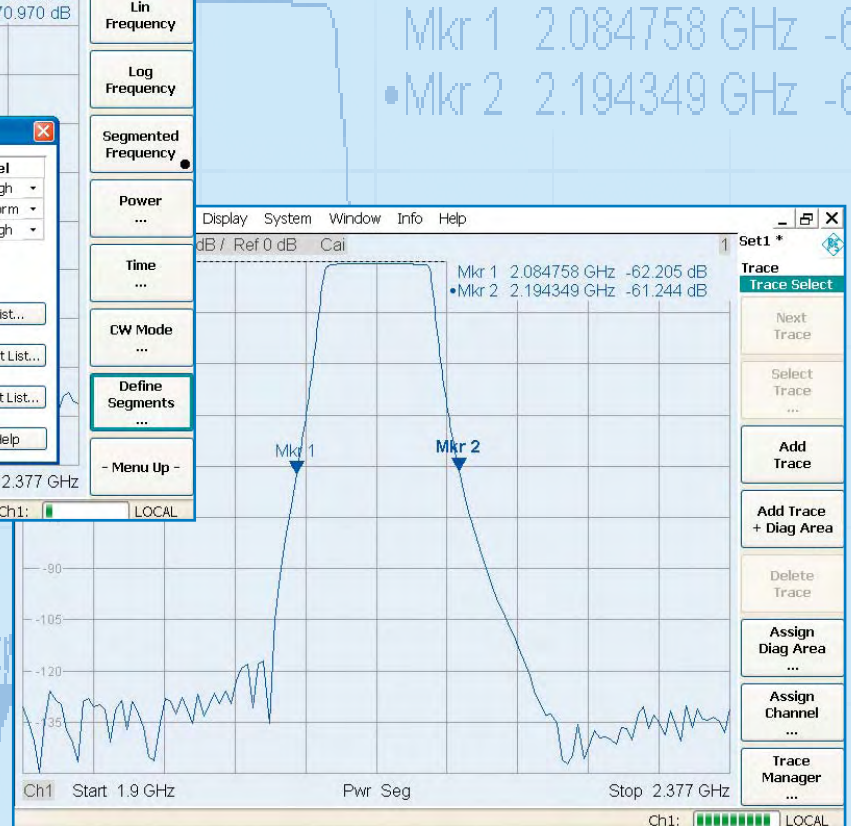

FIG 5 Transmission measurements on a base station filter.

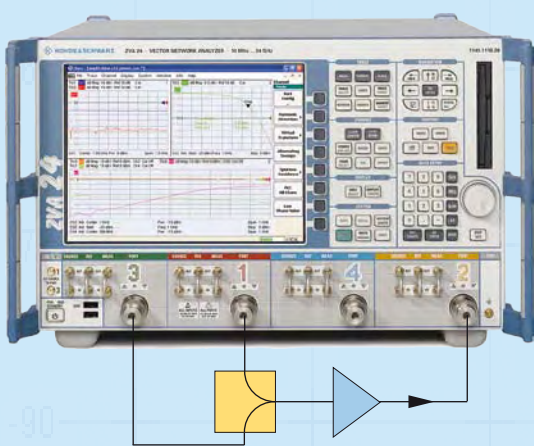

FIG 7 Test setup for intermodulation measurements without an external generator.

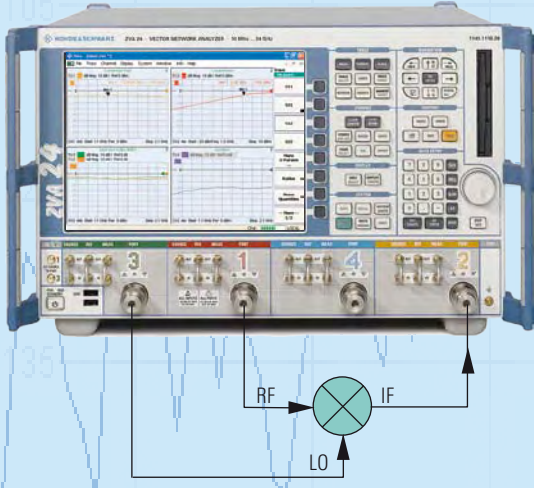

FIG 8 The second internal generator supplies the LO signal for mixer measurements.

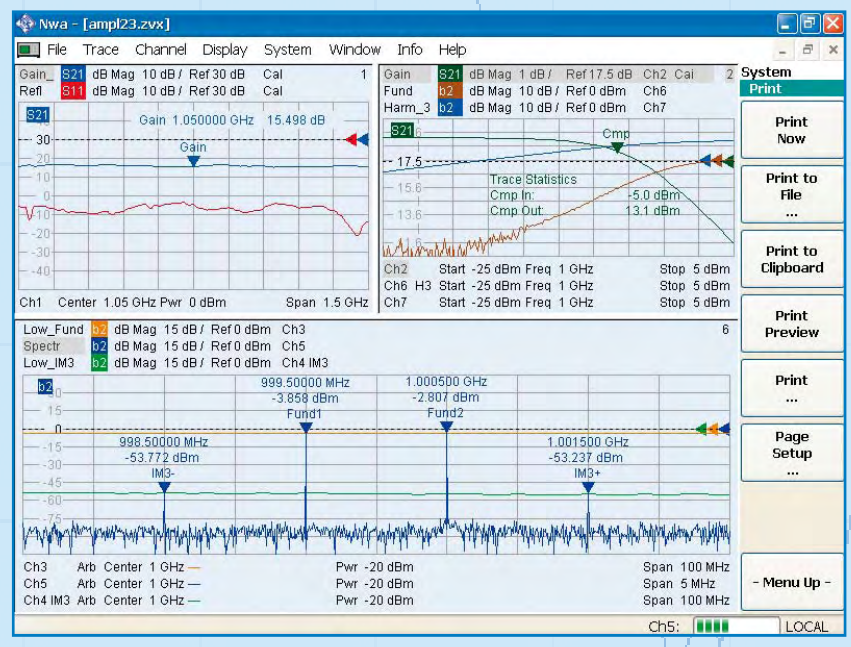

FIG 6 Characterization of an amplifier.

- ▶ Measurement speed can be further optimized by using segmented sweeps, where test parameters such as the IF bandwidth, number of test points and the generator level can be defined separately for each segment. Measurements can thus be focused on segments of interest, and carried out with the dynamic range and frequency resolution optimally adapted for each segment.

#### Data transfer in virtually no time

The R&S®ZVA hardware concept makes it possible to transfer data measured during the first sweep to the controller already during the second sweep via the analyzer's IEC/IEEE bus or LAN interface. This means that data transfer time is practically insignificant, which substantially cuts down on measurement time.

To further speed up automated test sequences, the R&S®ZVA provides channel bits at its trigger I/O port. The channel bits synchronize the DUT with the network analyzer, allowing limit values to be queried or external hardware to be controlled.

#### Fast switching between instrument setups

Previously, when measuring several DUTs, the required instrument setups had to be loaded from hard disk each time the DUT was changed. The R&S®ZVA can load various setups including calibration data into RAM and switch between these setups in less than 10 ms. To select the desired setup window, simply use the mouse in manual production applications; in automated test sequences, switchover is made by IEC/IEEE bus or LAN control (FIG 10).

#### True parallel measurements

The R&S®ZVA hardware concept allows true parallel measurements since the analyzer's internal generators can be switched to all test ports at the same time. For example, the R&S®ZVA four-

port model can analyze two two-port DUTs in parallel or measure the reflection of four one-port DUTs at its four ports in parallel.

#### Direct generator and receiver access

For some applications, external amplifiers, filters or attenuators have to be included in the test setup. This is possible by using the "Direct Generator / Receiver Access" option. This option in conjunction with the generator and receiver attenuator options turn the R&S®ZVA into an instrument that provides utmost flexibility in creating test setups.

Another positive effect of the direct access mode is that dynamic range increases to 150 dB (at 1 Hz IF bandwidth) since the internal couplers are bypassed. This is of interest when measuring high-blocking filters, for example.

#### Numerous calibration techniques

It goes without saying that a high-end network analyzer should provide a large number of calibration techniques. This is ensured by the R&S®ZVA hardware concept, which features a measurement and a reference receiver for each test port. This means that, in addition to classic TOSM calibration, modern 7-term calibration techniques can be used. These include TOM, TRL/LRL, TRM and TNA, some of which are of interest in particular for carrying out calibration in test fixtures or on wafers.

Manual calibration techniques are, however, time-consuming and error-prone especially where multiports are concerned. To solve this problem, Rohde & Schwarz offers an automatic calibration unit that comes in various models (FIG 11). Controlled by the network analyzer, the calibration unit performs complete four-port calibration

in less than 30 seconds, for example. Apart from saving time, automatic calibration units offer the advantage that they have to be connected only once to carry out a complete calibration. This means less wear to the connectors and thus an extended life. And, last but not least, automatic calibration practically excludes operator errors.

#### Summary

Superior RF performance combined with versatile use and extendability – these are the current requirements in the development and production of state-of-the-art components and modules. The R&S®ZVA from Rohde & Schwarz perfectly meets these requirements and, moreover, is easy to operate.

Andreas Henkel

More information, product brochure and specifications at  
[www.rohde-schwarz.com](http://www.rohde-schwarz.com)  
 (search term: ZVA)



# Set1 \*

**FIG 9**  
**Characterization of a mixer (conversion gain, matching, isolation and intermodulation).**

Trc1 S21 dB Mag 5 dB /  
 Trc2 S11 dB Mag 3 dB /

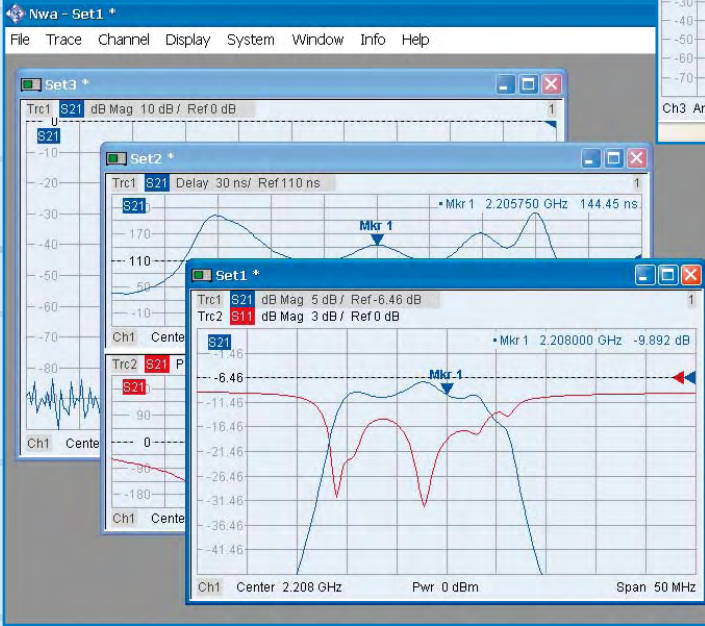
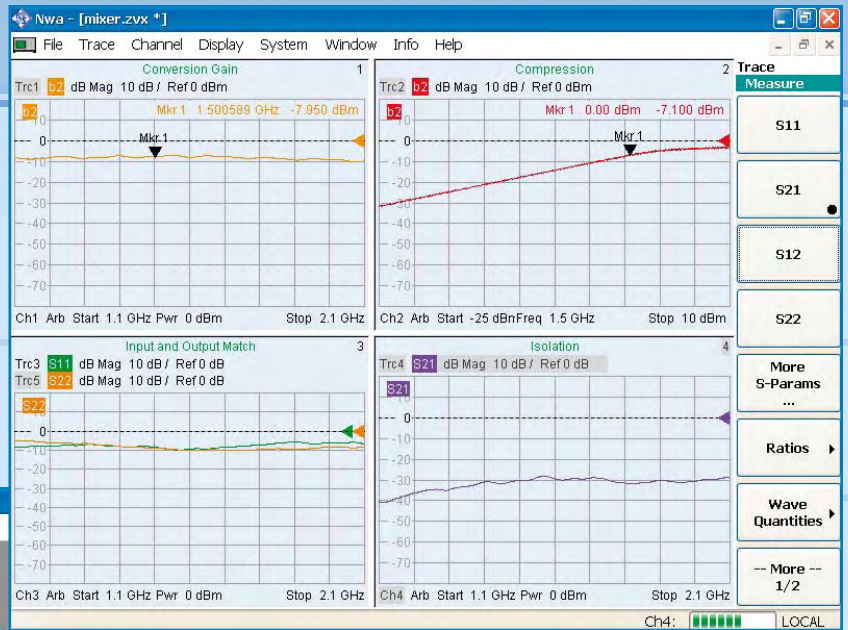

- Close
- Cascade
- Tile
- Maximize
- Set1 \* ✓
- Set2 \*
- Set3 \*

**FIG 10**  
 You can switch between setups in no time – simply by means of the mouse or via the IEC/IEEE bus.



**FIG 11** The automatic Calibration Unit R&S®ZV-Z51 saves time and prevents errors.

### Condensed data of the R&S®ZVA

Number of test ports	2 or 4
Frequency range	300 kHz to 8 GHz (R&S®ZVA8), 10 MHz to 24 GHz (R&S®ZVA24)
Measurement time per test point	<3.5 μs
Measurement time (201 test points)	4.5 ms
Data transfer time (201 test points)	
Via IEC/IEEE bus	<2.9 ms
Via VX11 (LAN with 100 Mbit/s)	<1.3 ms
Via RSIB (LAN with 100 Mbit/s)	<0.7 ms
Switching time	
Between channels	<1 ms
Between instrument setups	<10 ms
Dynamic range at 10 Hz measurement bandwidth	
Between test ports	>130 dB, typ. 135 dB
With direct receiver access	typ. 145 dB
Output level at test port	>+13 dBm, typ. +15 dBm
Level sweep range	>40 dB, typ. 50 dB
IF bandwidths	1 Hz to 1 MHz
Number of channels, diagrams, traces	>100 each (depending on available RAM capacity)
Number of test points per trace	2 to 20001
Operating system	Windows XP Embedded

Ch1 Center 2.208 GHz

Pwr 0 dBm

## ILS/VOR Analyzer R&amp;S®EVS300

# The specialist for terrestrial air navigation analysis

To check terrestrial air navigation equipment at national and international airports, you need a portable, versatile instrument that is fully optimized for high measurement accuracy. The ILS/VOR Analyzer R&S®EVS300 (FIG 1) optimally meets these requirements.

## Maximum precision analysis

Measurement accuracy, mobility and ruggedness are paramount in instruments designed for analyzing ILS or VOR signals in the field. For this reason, the R&S®EVS300 was devised as a mains-independent, portable level and modulation analyzer specifically for putting ILS and VOR systems into operation and for checking and maintaining them. Despite its compact size, the R&S®EVS300 provides measurement accuracy that is in a league with high-end laboratory equipment.

The R&S®EVS300's low weight, easy operability and internal storage of recorded measurement values are indispensable features on site. Due to its very low power consumption, you can per-

form measurements on outdoor installations a whole day without having to recharge the built-in battery. All these characteristics make the R&S®EVS300 ideal for mobile use.

The analyzer offers a full range of excellent features:

## ILS signal analysis

- ◆ Highly accurate localizer, glidepath and marker beacon measurements
- ◆ Comparative measurements between course and clearance signals

## VOR signal analysis

- ◆ Precise checking of CVOR/DVOR antenna systems in the field
- ◆ Selective measurement of modulation depth and deviation and display of useful and interfering signals

FIG 1 The R&S®EVS300 is rugged and extremely compact. Nevertheless, it features excellent measurement characteristics and a wide range of analysis functions.





### Further special characteristics

- ◆ Continuous frequency range from 70 MHz to 350 MHz
- ◆ Optional fast frequency scan across user-selectable frequency ranges with spectrum display and marker functions
- ◆ Very high dynamic range and high immunity to interference due to steep-edge preselector filters in the ILS/VOR and MB ranges; switchable preamplifier and high-level mixer
- ◆ Rugged and compact design for use in the field
- ◆ Battery-supplied operating time of 8 h to 10 h during continuous measurement

### General characteristics

- ◆ High-contrast TFT color display (16.4 cm / 6.4")
- ◆ Wide operating temperature range from  $-10^{\circ}\text{C}$  to  $+55^{\circ}\text{C}$
- ◆ Low weight (5.7 kg)
- ◆ High mechanical resistance in accordance with MIL-STD-810D and DIN IEC 68
- ◆ Self-test (BITE)
- ◆ LAN and RS-232-C interface for remote control of all functions and for measurement data output
- ◆ USB connector to easily export data and perform software updates

### Predestined for challenging measurement tasks

Although ILS transmitter systems include integrated monitoring functions, they require regular measuring and maintenance using independent equipment as an integral part of modern air traffic control. Especially the dynamic measurement of ILS signals by test vehicles along the runways is a key task of the institutions responsible for air traffic safety (FIGs 2 and 3).

The R&S®EVS300 is predestined to meet these challenges, considering

**FIG 2**  
The measurement of ILS signals along the runways is performed by means of test vehicles, with the R&S®EVS300 as the core component.



44 399/5

**FIG 3**  
ILS systems of the III b category require high-precision measurement instruments for checking the DDM values.



44 399/6

its numerous functions such as integrated recording of all relevant measurement parameters including GPS position data, optional external triggering and graphical display of the DDM characteristics. Used in conjunction with the R&S®HE 108 antenna, which was specially designed for such applications, the R&S®EVS300 is the key component of the measurement system. Its unique dual-channel signal processing capability allows simultaneous and independent measuring of course and clearance characteristics. The R&S®EVS300's high measurement speed and quick data storage ability plus the two channels help

to save time when performing measurements on runways, since no air traffic is allowed on the runway during these measurements.

Time is money – this is also true especially for measurement flights. Equipped with a second optional measurement channel, the R&S®EVS300 can simultaneously perform two independent measurement tasks on any frequencies, e.g. measuring the localizer and glideslope signals during the approach for landing, or checking two VOR stations. ▶

- ▶ An external GPS receiver determines the current position, which is then imported in NMEA 183 format. The exact location and time can thus be stamped on each block of measurement data. The data is then evaluated on site or in the lab using a USB stick or via LAN.

When measurement airplanes are used, steep-edge preselector filters in the R&S®EVS 300 prevent intermodulation products from being generated in the vicinity of powerful FM transmitters. If measurements are performed at the boundaries of a coverage area, the low-noise frontend ensures stable indication – even of signals that are far below the specified measurement range.

### Long-term measurements in the field

Another important task to ensure air traffic safety is to perform static measurements on ILS, marker beacon and VOR systems in the field – in addition to dynamic measurement sequences. To do this, you can use the R&S®EVS-Z3 dipole antenna for the ILS and VOR frequency ranges that has been specially designed for this application, together with a telescopic mast, which can be extended to 3 m (FIG 4).

The integrated data logger can be used for the above automatic measurements, plus it also supports the documentation of individual measurement values with manual triggering. Moreover, a long-term mode allows a static measurement sequence to be recorded. Owing to its low power consumption and sophisticated energy-saving mode, the R&S®EVS 300 can perform measurements in this mode for a whole week without requiring additional power supply.

### Impressive integrated functionality

Is the carrier frequency within the specified tolerance? Are the frequencies of the modulation signals okay? And how about the spectrum in the ILS/GS band? Are there any interferers? How do course and clearance signals influence each other? Is the phase angle of the two modulation signals okay? Up to now, questions along these lines could only be clarified by using elaborate test setups made up of several lab instruments.

The R&S®EVS 300 can easily handle these tasks. In the ILS, VOR and MB standard measurement modes, all relevant frequencies are continuously mon-

itored, making additional frequency counters superfluous. When checking CVOR/DVOR antenna systems in accordance with ICAO Doc. 8071, the R&S®EVS 300 analyzes both useful and spurious modulation (FIG 5). For adjusting outdoor installations, the analyzer provides, in addition to the conventional display of the measured values, an enlarged display, allowing you to easily read the display even from wider distances (FIG 6).

Owing to digital demodulation and filtering from the last intermediate frequency, the R&S®EVS 300 can analyze the two carriers of a two-frequency ILS system jointly or separately. This also enables the user to perform the usually very complex measurement of the phase relationship between the modulation signals of the course and clearance signal, which provides information on the antenna system alignment. The measurement of the respective signal levels is another important task – since the level ratio between the two signals has to be accurately complied with.

By using the Frequency Scan mode, which operates at selectable frequency ranges between 70 MHz and 350 MHz (FIG 7), you can analyze the spectrum of terrestrial air navigation signals, monitor frequency ranges and localize possible interferers.

Klaus Theißen; Dietmar Weber

#### Condensed data of the R&S®EVS 300

Frequency range	70 MHz to 350 MHz
Absolute level	-120 dBm to +13 dBm
Deviation at -30 dBm	<0.8 dB
Linearity error (-40 dB to +30 dB)	<0.5 dB
Inherent noise (bandwidth 32 kHz)	typ. -119 dBm
<b>ILS</b>	
DDM measurement, localizer mode	
Deviation $\leq \pm 10\%$ DDM	$\leq 0.0004$ DDM, $\pm 0.1\%$ of reading
Deviation $> \pm 10\%$ DDM	$\leq 0.0004$ DDM, $\pm 0.2\%$ of reading
DDM measurement, glideslope mode	
Deviation $\leq \pm 20\%$ DDM	$\leq 0.0008$ DDM, $\pm 0.1\%$ of reading
Deviation $> \pm 20\%$ DDM	$\leq 0.0008$ DDM, $\pm 0.2\%$ of reading
<b>VOR</b>	
Deviation 30/9960 Hz $\pm 2\%$	$\leq 0.5\%$
<b>Frequency scan</b>	
Frequency range	70 MHz to 350 MHz
Start/stop or center/span	selectable in the range from 70 MHz to 350 MHz
Level measurement range	-120 dBm to +13 dBm

Technical information at  
[www.rohde-schwarz.com](http://www.rohde-schwarz.com)  
 (search term: EVS300)



**FIG 4**  
Static measurements in the field with the R&S®EVS 300 and the R&S®EVS-Z3 dipole antenna.



Photo: DSF

**FIG 5** When checking CVOR/DVOR antenna systems in accordance with ICAO Doc. 8071, the R&S®EVS 300 analyzes both useful and spurious modulation.

**FIG 6** ILS measurement with enlarged display: The values are also legible from a wider distance.

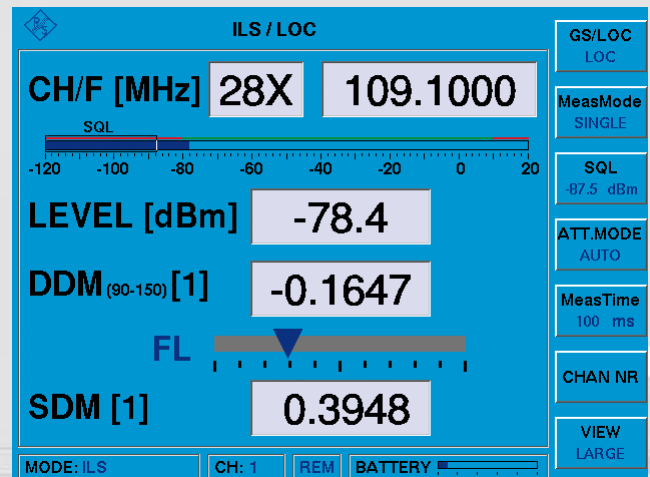

**FIG 7** Spectrum display with marker functions.

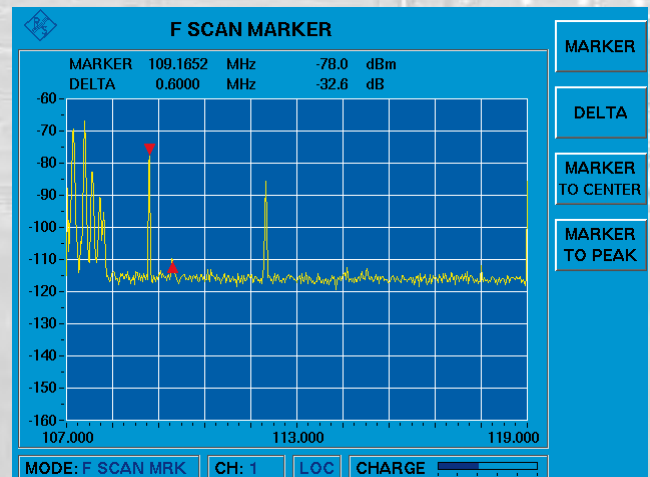

**Options**

- ◆ Second signal processing unit
- ◆ GSM modem
- ◆ NiMH battery
- ◆ Frequency Scan mode  
70 MHz to 350 MHz
- ◆ GPS mode

**Recommended extras**

- ◆ Weather protection bag
- ◆ Transit case
- ◆ ILS (LOC/GS) / VOR dipole antenna including telescopic mast and cable
- ◆ Antenna bag (for mast, cable and antenna)

## Signal Generators R&amp;S®SMx

# Perfectly simulated: GPS signals for complex localization scenarios

Due to the increasing use of the global positioning system (GPS) in the automobile and handheld industries, it has become a popular technology. Experts agree that GPS – and later also Galileo, which is the European counterpart – will open up yet another large market: The term *Assisted GPS* is already being used for the combination of mobile radio with satellite navigation. The R&S®SMU-K44 option expands the large scope of functions of the R&S®SMx signal generator family for generating real GPS signals.

## Up to eight satellites

In contrast to the predecessor of the R&S®SMx family – the Vector Signal Generator R&S®SMIQ, which simulated only one satellite – you can now simulate four realtime satellites with significantly expanded capabilities. By using the R&S®SMU or R&S®SMATE with a second baseband, you can even simulate up to eight synchronized satellites, which is necessary for some *Assisted GPS* test cases.

The signal generators are impressive with their easy and intuitive operating concept. By using the two modes *Generic* and *Localization*, you can either control the various GPS parameters in detail or automatically create a useful configuration at the press of a button. The R&S®SMx family with the R&S®SMU-K44 option is thus ideal both for development and production applications.

## Generic and Localization modes

In the *Generic mode*, you can configure up to four satellites as needed (FIG 1). In addition to various levels, this also includes the setting of different signal delays from which the receiver ultimately determines its location. It is especially important to adapt the individual Doppler shift for each simulated satellite. In practice, this shift results from the motion of the satellites relative to the receiver. In the simulation, the Doppler shift must be synchronized with the satellite paths described in the navigation message sent so that a receiver is able to determine the location. The *Localization mode* performs the exact setting of these parameters. This mode allows you to enter the place to be simulated, which is determined by longitude and latitude as well as altitude, or to select a city from a list (FIG 2). The appropriate satellite signals are then configured automatically; this allows you to send the GPS receiver any place in the world with only a few keystrokes.

## Real navigation data

To generate a highly realistic test signal, the new option allows you to generate the navigation message to be transmitted on the basis of real satellite data. This almanac data is updated several times a week, and is available on the Internet page of the US Coast Guard, for example. This data can then be transmitted to the signal generator via USB or LAN, which allows you to generate up-to-date test signals at any time. However, it is also possible to generate your own navigation message and integrate it in the form of a file.

FIG 1 Configuration menu of the four satellites that can be simulated.

	Satellite 1	Satellite 2	Satellite 3	Satellite 4
State	On	On	On	On
Space Vehicle ID	6	30	25	5
Ranging Code	C/A	C/A	C/A	C/A
Time Shift / P-Code-Chips	695 998	703 284	750 294	783 369
Time Shift / ms	68.035	68.747	73.342	76.576
Power / dB	-6.02	-6.02	-6.02	-6.02
Doppler Shift	896.32 Hz	2.080 69 kHz	2.312 35 kHz	152.18 Hz
Resulting Frequency / GHz	1.575 420 896 32	1.575 422 080 69	1.575 422 312 35	1.575 420 152 18
Resulting C/A Chip Rate / MHz	1.023 000 58	1.023 001 35	1.023 001 50	1.023 000 10
Resulting P Chip Rate / MHz	10.230 005 82	10.230 013 51	10.230 015 02	10.230 000 99

## Versatile use

The addition of the R&S®SMU-K44 option makes the R&S®SMx family usable in virtually any application. Especially in mobile radio development, a special GPS tester is thus no longer needed since the new option covers many tests – from easy sensitivity measurements through to complex localization scenarios.

A two-path R&S®SMU or R&S®SMATE can generate a complete GPS signal with the two L1 and L2 RF carriers including associated C/A or P codes in only one instrument (FIG 3). The AWGN module (option R&S®SMU-K62) and the optional Fading Simulator R&S®SMU-B14 allow you to perform simulations under realistic propagation conditions.

## Summary

One significant advantage of the R&S®SMx family compared to other GPS simulators is the combination of GPS signal generation with the know-how of many other standards, such as 3GPP FDD or GSM/EDGE, which are already available as options for the R&S®SMx family.

Due to the one-path, all-purpose R&S®SMJ 100 A, the R&S®SMx family is not only suitable for development applications but also for easy chip tests particularly in production. You can also set all GPS signal parameters by using SCPI commands via an IEC/IEEE bus (IEEE 488) or LAN (VXI-11, TCP/IP).

Gerald Tietscher

## GPS

The global positioning system (GPS) was developed by the US Department of Defense and is still under its direction. The principle of GPS is that a GPS receiver, which is located on the earth, receives the signals of several satellites and calculates its position on the basis of their delay differences. You need the signals of at least four satellites to determine the four unknowns (three space coordinates and time). The satellites transmit on two RF carriers (L1 = 1.57542 GHz, L2 = 1.2276 GHz) and identify themselves by means of a CDMA method via the two ranging codes C/A (coarse/acquisition, for civil applications) and P (precision, for military applications).

## Assisted GPS

In the case of *Assisted GPS*, a GPS receiver is integrated in a mobile phone and obtains information with regard to its approximate location via the mobile phone channel. This significantly reduces the time to first fix (TTFF) – the time up to the first localization.

FIG 2 Main menu for the Localization mode in the R&S®SMU200A.

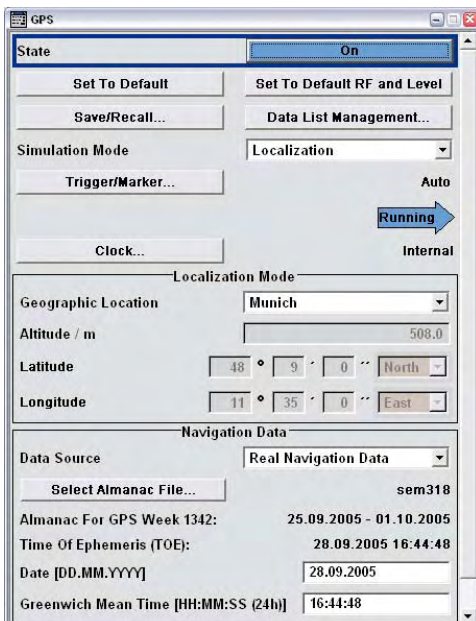
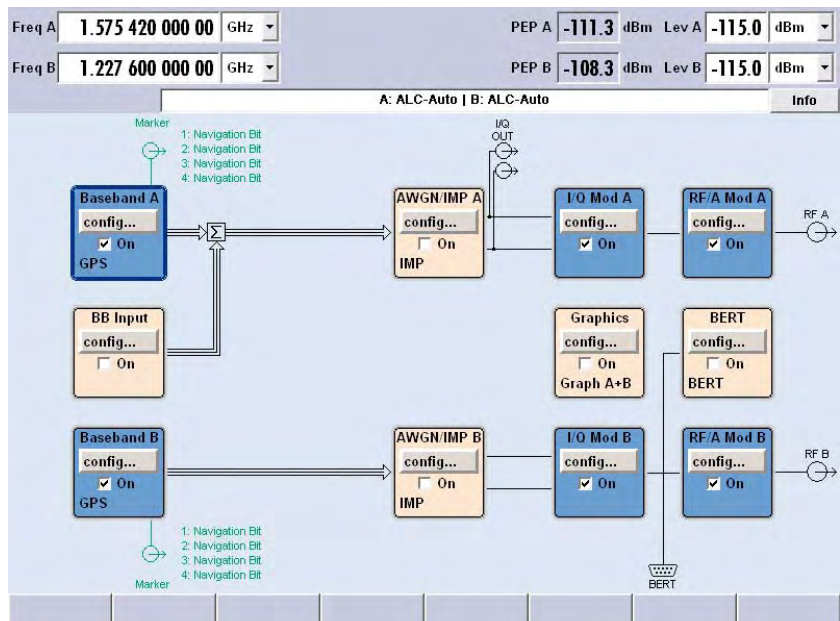

FIG 3 Generation of the L1 and L2 RF carriers in a two-path R&S®SMU200A.



## DTV Monitoring Receiver R&amp;S®ETX-T

# Trust is good, control is better – DVB-T monitoring

Numerous DVB-T transmitter networks have already started regular operation. New networks are continuously being added. The amount of money spent on transmitter technology is – and has been – significant, whereas investments in monitoring T&M equipment are often considered of minor importance. However, downtimes can be very expensive.

## Why invest in monitoring T&M equipment?

Usually, DVB-T transmitters are models of the latest generation, fully digitized and modular in design. Signals are generally applied to them via IP networks with a redundancy design, resulting in suitably high reliability. So why should you invest in monitoring T&M equipment?

Even the most state-of-the-art technology is subject to aging, resulting in altered signal quality or transmitter failure. Operation beyond the specified parameters or outright incorrect operation cannot always be avoided. As a result, program providers may claim recourse, or the number of viewers may drastically decrease – consequences which may prove very expensive.

Advanced monitoring T&M equipment from Rohde&Schwarz cuts down on these dangerous effects by informing network operators early on about problems and immediately signaling downtimes.

## Visionary due to a wide dynamic range

The DTV Monitoring Receiver R&S®ETX-T (FIG 1) has been specially designed for DVB-T signals. The R&S®ETX-T controls the most important signal parameters and provides accurate information about the quality of an applied DVB-T signal. The receiver can inform network operators at a very early stage about looming disruptions, thus providing a glance into the future. This capability can be compared to driving at night:

FIG 1 DTV Monitoring Receiver R&S®ETX-T.



The brighter the headlights of a car, the better the driver's vision – and the earlier possible obstacles can be detected. The R&S®ETX-T has a similar concept: Due to its wide dynamic range, infinitesimal changes in the monitored transmitter parameters can be detected at a very early stage. Thus, conclusions can be drawn. This helps to save time and take appropriate countermeasures.

## Versatile applications

Unlike simple receive modules, the R&S®ETX-T provides you with a wide variety of measurements and functions, reflecting its versatile applications. The R&S®ETX-T primarily records all major RF parameters of an emitted DVB-T signal on the transmitter and internally stores the measurement data. This makes it easier for transmitter operators to furnish proof of quality of service (QoS), for example. The receiver outputs alarm messages if one or several selected parameters exceed the specified limits.

Both its measurement capabilities and its previously mentioned dynamic range match those of a high-end TV test receiver. And since the R&S®ETX-T can be remote-controlled, problems can be narrowed down from anywhere; there is no need for a measurement technician to visit the site with additional measuring equipment.

The monitoring receiver is equipped with a selective RF input section. An internal preamplifier and optional SAW filters ensure excellent receive characteristics; used with a common receiving antenna, these characteristics make the R&S®ETX-T also ideal for use as a monitoring receiver within a coverage area. A combined monitoring and measurement receiver in a single instrument, the R&S®ETX-T is a favorably priced solution for current and future tasks.

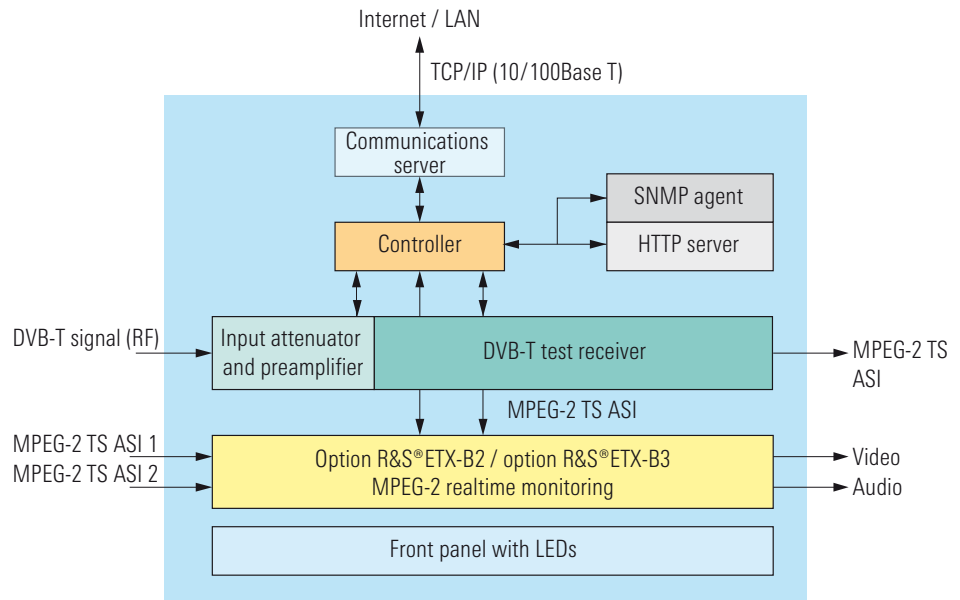

FIG 2 R&S®ETX-T block diagram.

## Setup details

The incoming DVB-T signal passes through an input attenuator (which can be switched manually or automatically) before it is applied to the receive section (FIG 2). The receive section is narrowband; using SAW filters, selectivity can be optionally increased, for example if the receiver is not to be used directly on the transmitter. The OFDM demodulator provides the analysis section with the data required for evaluation; the demodulated MPEG-2 transport stream is applied at the TS-ASI output.

The R&S®ETX-T can be upgraded with an MPEG-2 decoder, which is optionally supplied with or without audio and video outputs. Both versions allow easy MPEG-2 monitoring of the main parameters in accordance with TR 101 290. Each decoder has two external inputs. You can switch between these inputs and the internally demodulated transport stream for MPEG-2 monitoring. You can thus also monitor the transport streams applied at the transmitter.

## Operation and communications

The receiver is controlled and operated only via its LAN interface (TCP/IP), so the front panel is very straightforward. LEDs indicate the operating state and the LAN connection and signal alarm messages.

The R&S®ETX-T can be accessed in two different ways. An Internet-capable terminal such as a PC, notebook or PDA is required for direct access. You don't need special software; a common web browser is sufficient. You have to log on to the receiver, specifying your user name and password. The receiver manages access and user rights, which can be assigned as required: from the right to see just a few parameters through to full administration rights. The user interface is automatically adapted to reflect the rights assigned.

But the receiver can also be accessed via the standardized SNMP protocol, which allows you to easily integrate the receiver into management programs. An SNMP agent integrated into the

- ▶ R&S®ETX-T handles communications. In the case of a failure, the SNMP agent sends SNMP traps to the management program to raise an alarm, or it raises the alarm directly via the Internet.

The R&S®ETX-T comes equipped with seven floating relay contacts as standard, which are provided at its rear panel; it can thus be used in conjunction with older, contact-based monitoring systems. Each relay contact can be user-assigned to one or more RF alarm messages.

### Monitoring functions

The R&S®ETX-T monitors all parameters that thoroughly describe the quality of a DVB-T signal: level, synchronization, modulation error ratio (MER), bit error ratio before and after the Viterbi decoder plus data errors in the MPEG-2 transport stream. To get an overview of all measurement values, view the main page of the R&S®ETX-T (FIG 3). Symbols and coloring indicate whether the individual parameters are in the permissible or non-permissible range. Auxiliary information and statistics complement the overview.

You decide which of the parameters are to be monitored. The receiver records the states and the subsequent alarm messages of the selected parameters in separate reports. The reports can be viewed (FIG 4) or exported at any time. This simplifies handling if a higher-level management program is involved since the values need not be continuously and explicitly queried.

### Attractive Scan mode

Several multiplexes are usually broadcast at a transmitter site on different frequencies, each of which needs to be monitored. As a rule, a separate monitoring receiver should be used for each multiplex. This is where the R&S®ETX-T comes in, offering an attractive, cost-efficient solution: In the Scan mode, the R&S®ETX-T sequentially processes any frequency table the user may compile and is thus able to systematically check all the multiplexes to be monitored. The R&S®ETX-T covers measurement values and alarm messages separately according to frequency.

### Measurement functions

The R&S®ETX-T provides measurement functions far exceeding the requirements of common measurements; it opens up comprehensive solutions to analyze disruptions and pin down their causes. For example, the receiver displays the frequency spectrum, measures shoulder attenuation and shows the CCDF without requiring a spectrum analyzer. The displays of constellation and MER versus all OFDM carriers help to locate modulator errors or disruptions in the transmission path.

### Single frequency networks – a special case

DVB-T networks can also be operated as single frequency networks (SFN). To ensure interruption-free operation of these SFNs, all transmitters must have exactly the same phase angle. The monitoring receiver provides a precise display of the channel impulse response, thus furnishing an exact overview of the SFN status. The inserted guard interval display is highly useful; it presents the accurate time domain depending on the selected modulation parameters (FIG 5). The individual impulses are recorded with <0.5 dB precision in the level range, and <20 ns in the time domain. The R&S®ETX-T is thus more than ready for monitoring the impulse response.

### Summary

The DTV Monitoring Receiver R&S®ETX-T is outstanding with its superior dynamic range and versatility – characteristics that help network operators to detect and analyze problems early on. Thus, disruptions can be completely avoided or at least swiftly remedied. This makes the R&S®ETX-T an investment that will quickly break even.

Werner Dürport

More information and data sheet at  
[www.rohde-schwarz.com](http://www.rohde-schwarz.com)  
 (search term: ETX-T)





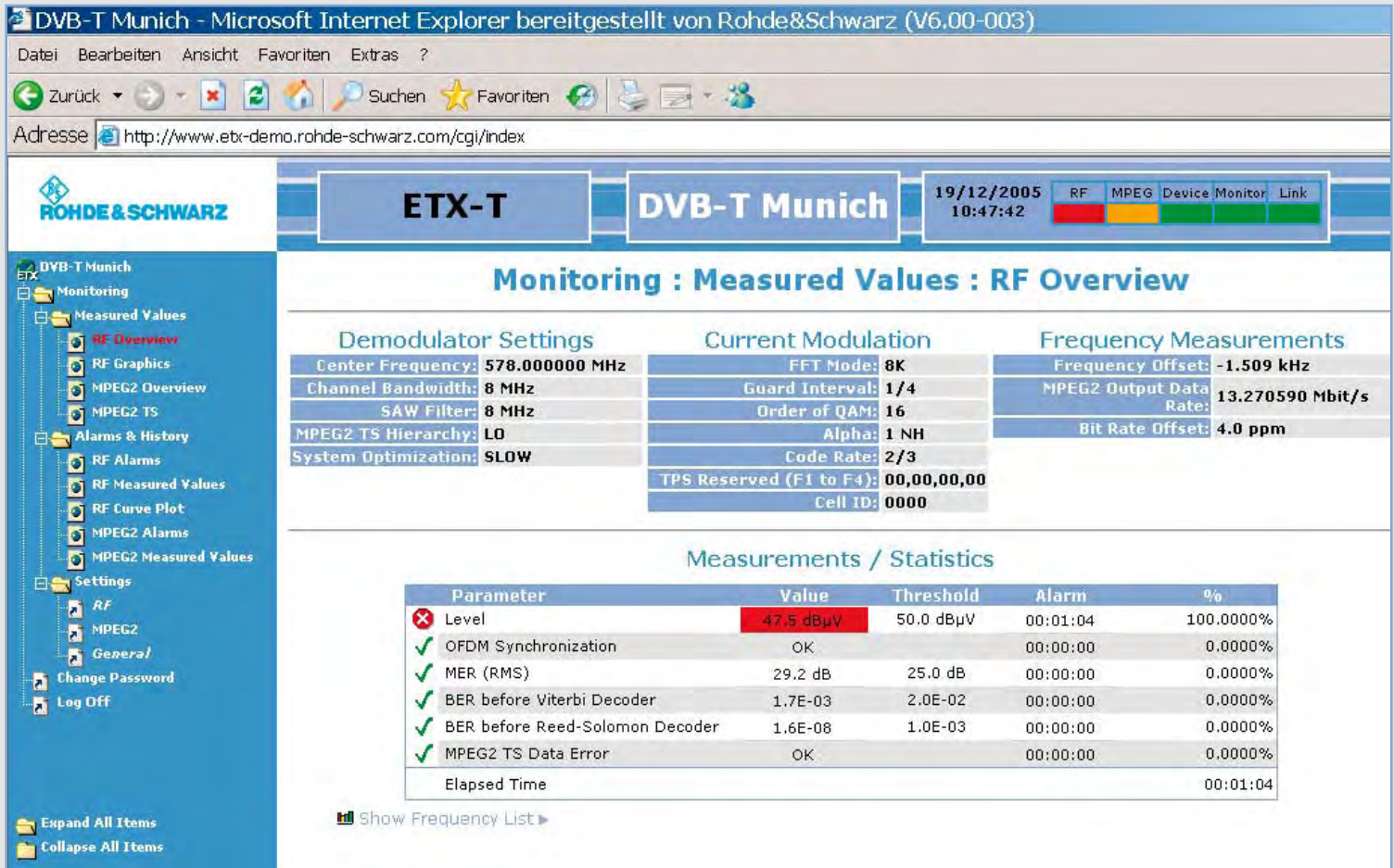

FIG 3 Information about selected DVB-T channel, status and error statistics at a glance.

Date	Time	Frequency	Synchr.	Level	MER	BER(BV)	BER(BR)	MPEG2 ERR.
19.12.05	10:50:42	578.000000 MHz	OK	47.4 dBμV	9.2 dB	8.0E-02	3.1E-07	OK
19.12.05	10:50:21	578.000000 MHz	OK	47.5 dBμV	29.5 dB	1.4E-03	0.0E+00	OK
19.12.05	10:49:59	578.000000 MHz	OK	47.4 dBμV	29.4 dB	1.4E-03	0.0E+00	OK
19.12.05	10:49:40	578.000000 MHz	OK	47.5 dBμV	29.6 dB	1.4E-03	8.0E-08	OK
19.12.05	10:49:17	578.000000 MHz	OK	47.5 dBμV	29.5 dB	1.4E-03	0.0E+00	OK
19.12.05	10:48:57	578.000000 MHz	OK	47.6 dBμV	28.9 dB	1.3E-03	0.0E+00	OK
19.12.05	10:48:37	578.000000 MHz	OK	47.5 dBμV	29.6 dB	1.4E-03	0.0E+00	OK
19.12.05	10:48:16	578.000000 MHz	OK	47.5 dBμV	28.6 dB	1.6E-03	0.0E+00	OK
19.12.05	10:47:40	578.000000 MHz	OK	47.5 dBμV	29.2 dB	1.7E-03	1.6E-08	OK
19.12.05	10:47:17	578.000000 MHz	OK					
19.12.05	10:46:57	578.000000 MHz	OK					
19.12.05	10:46:38	578.000000 MHz	OK					

FIG 4 Reports of measurement values and alarm messages (top) and (right) measurement results of level (blue) and MER (orange).

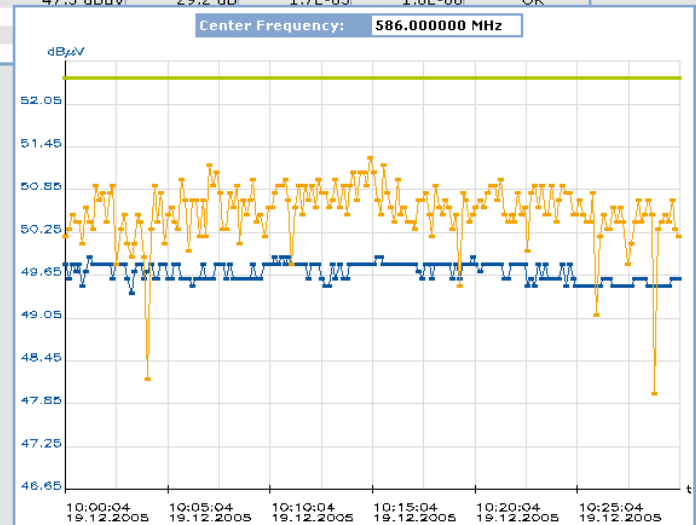
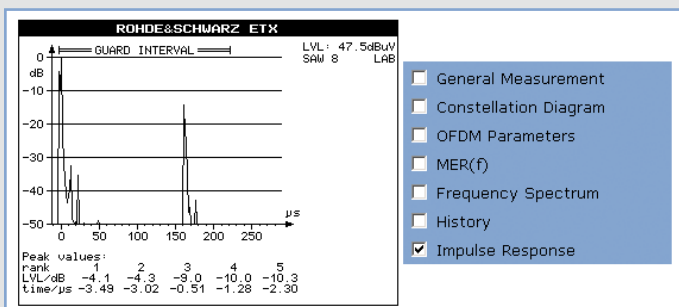

FIG 5 The impulse response is the main display to control SFNs. This page can only be accessed by maintenance staff or the operator.



# Generating and analyzing transport streams for DVB-H

**The DVB-H standard has been specified for supplying broadband data services to mobile terminals. In contrast to DVB-T, the emphasis is on robust transmission, support of mobile reception and saving energy in terminals. Rohde&Schwarz provides new software and options for generating and analyzing DVB-H transport streams.**

## Key features of DVB-H

Transport streams for DVB-H are based on the structure of DVB-T transport streams, and may include services that are compatible with both DVB-T and DVB-H. The IP/MAC notification table (INT) signals whether a DVB-H service is included in the transport stream.

In DVB-H, the IP data (payload) belonging to a service is transmitted via multi-protocol encapsulation (MPE), a method that describes the transport of IP data in MPEG-2 data streams. A typical application is the transmission of video data with low resolution (e.g. H.264-coded). The IP data is divided into blocks of data called sections for transport. A high level of error protection is ensured on the transmission path by means of special error protection data, which is transmitted in its own sections together with the payload (MPE-FEC). The service provider defines the proportion of protection data to payload.

The introduction of DVB-H also included the introduction of time slicing, where the data of a DVB-H service is transmitted in bursts. The service provider defines the distances between the bursts and the length of each burst within a range specified by the standard. Time slicing reduces energy consumption in the receiver since the receiver can switch off its receiving unit between bursts.

## Transport streams from library or by means of software

To test DVB-H-compatible terminals, you need transport streams with the above characteristics. Rohde&Schwarz meets this need by offering a DVD with a large collection of transport streams with contents coded in different ways and a wide variety of parameters for time slicing [\*].

However, some applications require customer-specific transport streams, such as in the following cases:

- ◆ When special contents are used
- ◆ When customized DVB-H parameters are applied
- ◆ When DVB-H services are combined with special DVB-T programs, etc

To enable you to make your own transport streams, Rohde&Schwarz offers the Advanced Stream Combiner R&S®DV-ASC software option. With just a few keystrokes, you can generate DVB-H-compatible transport streams with your own parameters. R&S®DV-ASC is an expansion of the tried-and-tested Stream Combiner R&S®DVG-B1 for generating MPEG-2 transport streams for various transmission methods such as DVB-T, DVB-S, DVB-C and ATSC.

The DVB-H interface in R&S®DV-ASC is intended for IP data saved in files. You can use your own IP data or select from a large collection which comes with the DVB-H Stream Library DVD <sup>1)</sup>. The software automatically inserts or calculates all DVB-H characteristics. FIG 1 shows the user interface of the Advanced Stream Combiner software; the screenshot in the foreground shows the window for setting time slicing and FEC parameters.

More information and a demo version of the R&S®DV-ASC software at [www.rohde-schwarz.com](http://www.rohde-schwarz.com) (search terms: DVM/DV-ASC/DV-DVBH)

[\*] The "DVB-H Stream Library R&S®DV-DVBH" DVD is available from any Rohde&Schwarz office.

1) The replay of these contents is only possible if the DVB-H Stream Library option is enabled on the instruments used.

The transport streams that have been generated by using the software and also the transport streams of the ready-made library can be replayed with the generators in the Broadcast Test System R&S®SFU and the Digital Video Measurement System R&S®DVM 400, as well as with the DTV Recorder Generator R&S®DVRG.

## Analysis functions

The measurement functions of the R&S®DVM family have also been expanded to enable you to analyze all DVB-H-specific features:

- ◆ Correct signaling and integration into the transport stream
- ◆ Interpretation of the INT
- ◆ Detailed syntax analysis und interpretation of the MPE sections
- ◆ Evaluation of error protection
- ◆ Time slicing measurement with graphical display (FIG 2)
- ◆ Data extraction and video content decoding (if codec is known)

All functions mentioned above are available with the Data Broadcast Analysis R&S®DVM-K11 option for all instruments of the R&S®DVM family. The base units can already recognize DVB-H services and measure the data rate (PID level). You can use the In-Depth Analysis R&S®DVM-K10 option to interpret the INT.

Thomas Tobergte

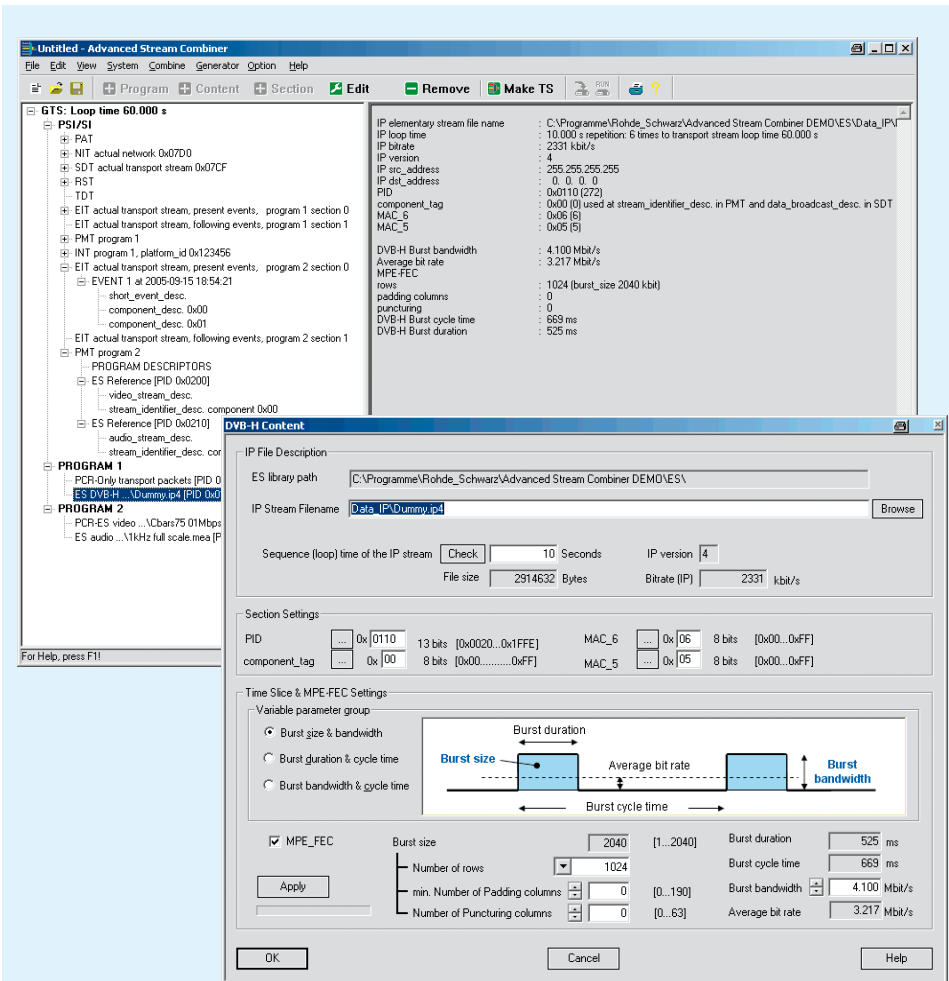

FIG 1 Setting of the DVB-H parameters with the Advanced Stream Combiner R&S®DV-ASC software option.

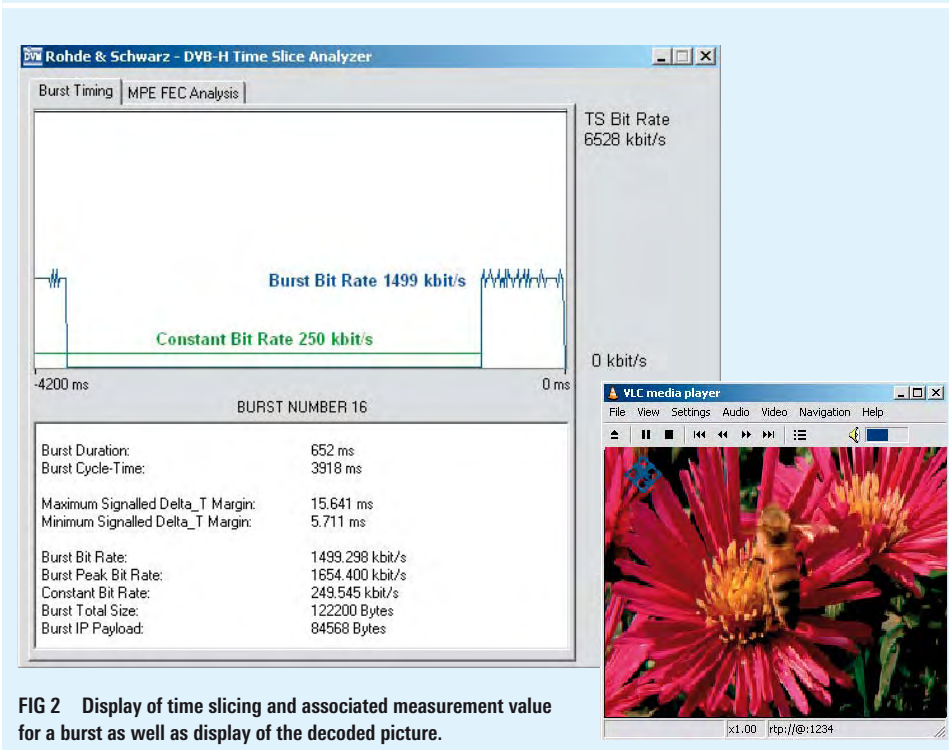

FIG 2 Display of time slicing and associated measurement value for a burst as well as display of the decoded picture.



44316/1

FIG 1 The Control Unit R&S NetCCU® 800 can be used both in the TV and FM transmitters of the R&S®Nx8000 family.

**The Control Unit R&S NetCCU® 800**  
is the distributing center and user  
interface for the new successful  
R&S®Nx8000 transmitter platform.

Control Unit R&S NetCCU® 800

## Common control unit for FM and TV transmitters

### Switching center for two transmitter families

The Control Unit R&S NetCCU® 800 (FIG 1) is included as a common distributing center both in the new generation of R&S®NH/NV8200 TV transmitters [1] and in the new family of VHF FM Transmitters R&S®NR8200 [2]. For network operators, this has the advantage of low operation and training costs as well as simplified logistics with regard to stock-keeping of spare parts. For the first time, the control concept and user interfaces in TV and FM transmitters are uniform. This also simplifies their integration into network management systems and facilitates the setup and putting them into operation, plus reduces maintenance and service costs.

### Innovative control concept

A transmitter system mainly consists of an exciter, amplifier, cooling system and transmitter control unit. Depending on the output power or redundancy concept, these components are present in multiples. The central control unit's (CCU) task is to display the system parameters, to monitor them and to perform redundancy switching in the event of an error. To maximize the performance, the R&S NetCCU® 800 is connected with the exciters via Ethernet and with the amplifiers via a CAN bus (FIG 2).

### Remote control and local operation

The color display (1/4 VGA) and the keys on the front panel are used for local operation of the transmitters. The

More information at  
[www.rohde-schwarz.com](http://www.rohde-schwarz.com)  
(search term: NetCCU800)

#### REFERENCES

- [1] UHF TV Transmitters R&S®NH/NV8200: Air-cooled transmitters for the medium-power segment. News from Rohde & Schwarz (2005) No. 185, pp 40–42
- [2] Family of VHF FM Transmitters R&S®NR8200: Compact, air-cooled transmitters for 2.5 kW to 30 kW. News from Rohde & Schwarz (2005) No. 186, pp 44–45
- [3] Transmitter Control Unit R&S NetCCU® 700: All-purpose instrument with integrated DVB-T receiver module. News from Rohde & Schwarz (2005) No. 185, pp 34–37

straightforward menus provide access to all parameters of the transmitter system. You can call up setting ranges and a brief description for each parameter; this especially facilitates the system's occasional on-site use (FIG 3).

Since the R&S NetCCU® 800 uses Java software and the XML description language, the menus can easily be adapted to customer-specific requirements (e.g. other languages).

In addition to the increasingly important remote control of unattended stations, network management systems of the network operator can be directly connected with the control unit and communicate with its integrated SNMP agent. The agent automatically informs the control center about errors on the transmitter station via SNMP trap. The CCU is also equipped with a web server, providing the maintenance personnel, which is often at different sites, access to all parameters of the transmitter system when and where needed (FIG 4). Structure and content of the menus are identical to the local operation of the transmitter via display.



**FIG 2**  
Designed to achieve high performance: The Control Unit R&S NetCCU® 800 communicates via Ethernet or a CAN bus with the transmitter components.

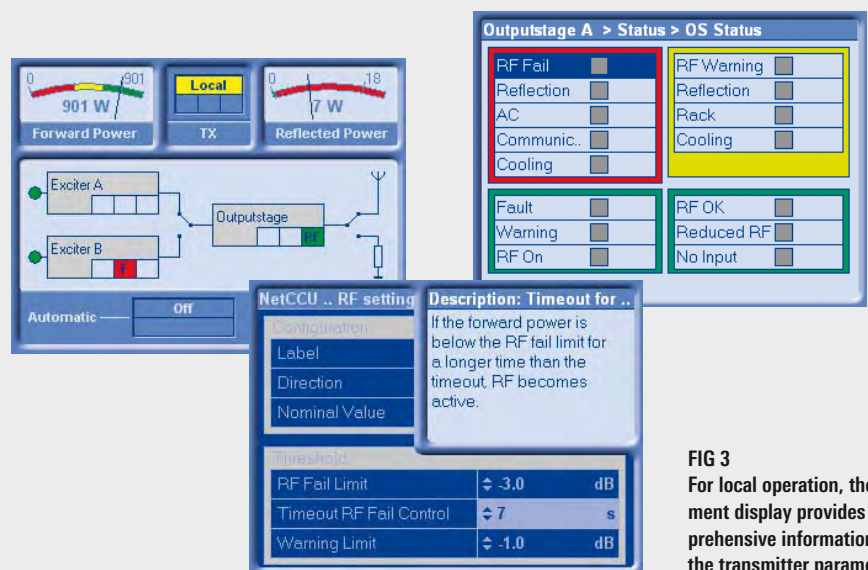

**FIG 3**  
For local operation, the instrument display provides comprehensive information about the transmitter parameters.

## DVB-T receiver module option

As with the predecessor model of the control unit, the DVB-T receiver module option [3] is available for monitoring the output signal of a DVB-T transmitter. This allows monitoring of important parameters such as MER, BER, S/N, input level and modulation mode and call them up via the user interfaces (local, SNMP and web). In the retransmitter application, this option is used to cost-efficiently feed the modulation signal when receiving the RF of a master transmitter.

Manfred Reitmeier

**FIG 4** Convenient remote control via a web browser.

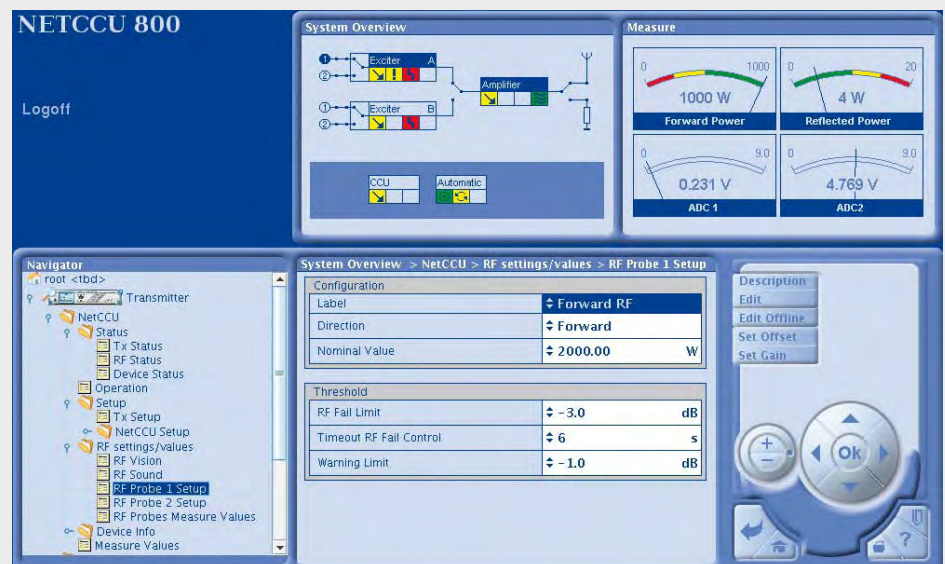

# Central cooling systems for high-power TV and DVB-T transmitters

**Rohde & Schwarz offers not only standard transmitter cooling solutions with their own pump assemblies but central cooling systems for larger transmitter groups. You can adapt the systems to any power class.**

## Proven in practice

The new central cooling systems have already proven themselves in practice: T-Systems installed them at Alexanderplatz in Berlin and in the Olympic tower in Munich. The cooling power for seven DVB-T transmitters in power classes 1.7 kW to 2.75 kW in Berlin is  $2 \times 80$  kW. The central cooling system in Munich's Olympic tower provides a cooling power of  $2 \times 160$  kW for six DVB-T transmitters with output power ranging from 7.5 kW to 9.4 kW.

## Trouble-free operation has top priority

The central cooling systems consist of two separate lines and ensure utmost operational reliability. In the unlikely event of an error or during maintenance work, the two lines are intercon-

connected by mechanical bypass valves. The cooling systems are equipped with two circulation pumps and two coolers each. Mixers (three-way valves) provided in the cooling circuit ensure a constant operating temperature of  $22^{\circ}\text{C}$  and prevent condensation on coolant lines and transmitters.

The circulation pumps are operated in passive standby. Switchover is performed by the MSR (management control and regulation

engineering tool) which controls and checks the cooling systems. To attain equal run times of the pumps, you can set the MSR to switch over daily, weekly or monthly. The actively operated coolers contain four fans each and are connected individually by the MSR depending on the cooling power requirements. You can manually disconnect a defective cooler by using the bypass valves. If a cooler fails, the large power margin ensures that the remaining coolers can absorb the heat from the transmitters without the operating temperature of the transmitters increasing significantly.

A controller in the MSR records the temperature values required to control the pumps and the coolers. Control and query data to PCs or systems can be transmitted to a remote-control system via an RS-485 interface.

All coolant lines are made of high-grade steel and are heat-insulated inside and outside. The coolant lines and control circuit have been prepared to connect the cooling systems to external heat pumps in order to make use of the waste heat. The waste heat of the central cooling system implemented in Munich's Olympic tower, for example, is used in an intelligent manner: It will help to heat the swimming pool next to the tower.

The compact central pump and cooler assembly in the cooling systems is a clear advantage in transmitter stations where space is usually at a premium. Large differences in height between the pump and cooler positions can also be handled. To ensure this, a second cooling circuit with a heat exchanger to compensate for the pressure differences must be installed.

Franz Maurus

The central transmitter cooling system in Munich's Olympic tower.



44390/4

Many transmitters operate above 3 GHz, the frequency limit of conventional receivers. Some of them are used for WLAN applications, but also for broadcasting and TV satellites as well as for microwave and radar systems. It is necessary to monitor all these transmitters, determine their data in order to plan reliably, and find possible interference in this range.

Portable Microwave Monitoring System R&S®TMS500

## Portable monitoring system for frequencies up to 110 GHz

### Increasing demand for frequency in the microwave range

The increasing need for powerful computer networks is also boosting the demand for fast data links, which are increasingly being implemented via radio links. Since frequency bands are already densely occupied, users are often forced to switch to higher frequency ranges. However, numerous types of radio equipment and radar systems already operate in this range. Regulatory authorities thus have to monitor

the entire microwave range up to 40 GHz and above to identify unauthorized emissions and to set up a reliable database for future frequency assignments.

In the microwave range, you will often find directional radio links with antennas with strong directivity. In the event of interference, these antennas cannot be examined from just any fixed measurement stations. Instead, you have to set up the measurement system at the location of the receiving antenna with interference. ▶

FIG 1 The Portable Microwave Monitoring System R&S®TMS500 is ready for on-site operation within a few minutes.



43386/1

### ► Mobile systems in demand

The Transportable Microwave Monitoring System R&S®TMS500 – another member of the R&S®TMS family [1] – is ideal for this purpose (FIG 1). The instrument is well-protected in a portable rack, enabling quick and easy setup on site, and is ready for operation within only a few minutes. Only a power connection is needed (100 V to 240 V AC supply voltage). The measurement antenna is mounted on a tripod and is moved to the desired position.

The Spectrum Analyzer R&S®FSP30, which is the heart of the system, provides a quick overview of the frequency range of interest and is also able to measure numerous signal parameters. The R&S®GPS 129 frequency standard, which is integrated in the system and synchronizes to GPS satellites, not only provides the exact position but also ensures high frequency accuracy in all of the measurement equipment.

The standard R&S®TMS500 operates in the frequency range from 1 GHz to

26.5 GHz. By adding five optional microwave converters, you can cover a frequency range of up to 110 GHz. Each converter is accommodated in a sturdy transit case together with the appropriate measurement antenna; it can easily be mounted on a tripod and is then ready to use (FIG 2).

The system is operated via a notebook by using the tried-and-tested user-friendly Spectrum Monitoring Software R&S®ARGUS [2]. You can use the system both interactively on site (FIG 3) and perform automatic measurements. These automatic measurements are, for example, particularly useful and effective when you have to perform measurements according to a fixed schedule or when searching for interference that only occurs sporadically. During this process, the system can continuously monitor the corresponding frequency range. As soon as the interference occurs again, the frequency is examined closely to identify the transmitter, including the recording of the audio signal demodulated by the spectrum analyzer. The system can also transmit an alarm message to a control center.

Of course, you can remote-control the system via the integrated LAN connector. The Transportable Communication System R&S®TMS-C (FIG 4) is ideal for this purpose. This combination was used successfully in seven test vehicles [3] during the Olympic Games in Athens in 2004.

The system has a wide range of measurement capabilities. For example, it can display the spectrum (FIG 5) and measure the level as well as determine available and occupied frequencies. In addition, it can search for and determine the position of unauthorized transmitters and radiated interferences. Moreover, it can measure radar signals.

By using a directional antenna on a rotator (controlled by the Antenna Control Unit R&S®GB 127M via R&S®ARGUS, for example), you can measure the receive level with reference to the azimuth angle (FIG 6). The R&S®TMS500 thus allows direction finding even up to 110 GHz.

Wolfgang Seidl; Thomas Krenz

**FIG 2** Five optional microwave converters expand the monitoring system for frequencies up to 110 GHz. You can easily mount a converter on a tripod, which is then ready to use.



44 429/2



**More information about all radiomonitoring products from Rohde & Schwarz at [www.rohde-schwarz.com](http://www.rohde-schwarz.com)**

#### REFERENCES

- [1] Transportable Monitoring and Direction Finding Systems R&S®TMS: Versatile solutions for spectrum monitoring. News from Rohde & Schwarz (2002) No. 175, pp 47–51
- [2] Spectrum Monitoring Software R&S®ARGUS: The successful “classic” now available as version 5. News from Rohde & Schwarz (2003) No. 177, pp 46–50
- [3] Spectrum Monitoring and Management System R&S®ARGUS-IT: Nationwide radiomonitoring system for Greece. News from Rohde & Schwarz (2005) No. 185, pp 48–49



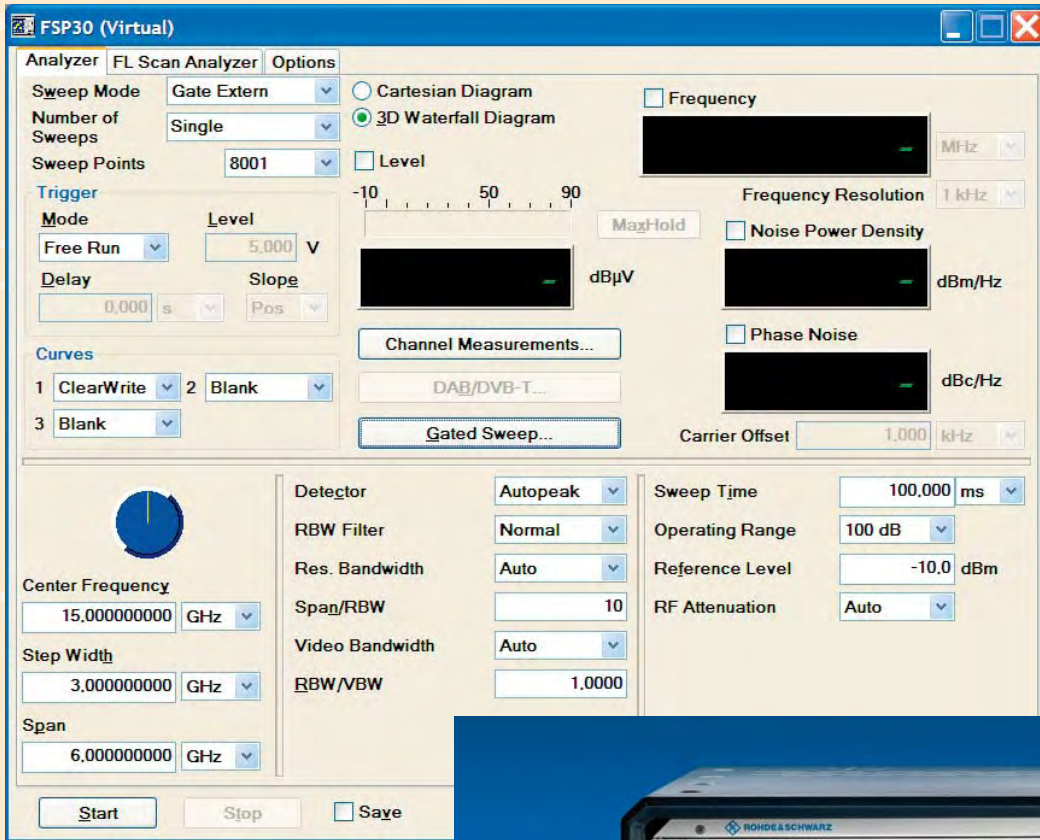
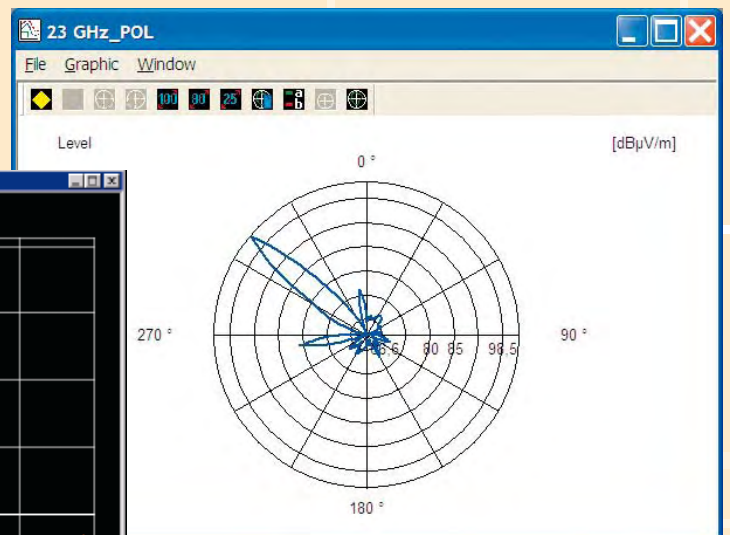
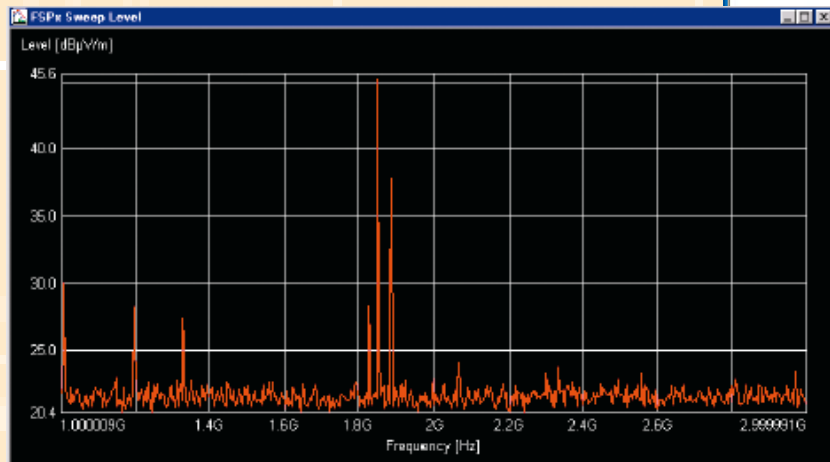

**FIG 3**  
By using Spectrum Monitoring Software R&S®ARGUS, you can conveniently operate the system. This figure shows the settings for the Spectrum Analyzer R&S®FSP30.



**FIG 4**  
The monitoring system can be completely remote-controlled by using the Transportable Communication System R&S®TMS-C.

**FIG 5**  
Display of the measured spectrum.



**FIG 6**  
By using a directional antenna on a rotator, you can measure the receive level as a function of the azimuth angle.



Setup of TETRA radio system in Russia

At the end of September 2005, Rohde & Schwarz participated in an international conference in Moscow on setting up a uniform TETRA radio network. The conference was organized by the magazine *Network Computing & Telecommunications* and the Russian Ministry of Communications and Information.

Max Zerbst, Vice President of R&S BICK Mobilfunk, lectured on Rohde & Schwarz TETRA solutions for mission-critical communications in front of many representatives from governmental agencies as well as providers and manufacturers of radio technology. These solutions are based on the IP-based Mobile Radio Communications Architecture IpMCA® and can be adapted to new technological developments by means of appropriate updates (see article on page 4). They thus provide safety of investment and flexibility, which are also of immediate importance to Russia. Since Russia has several radio communications systems which are not compatible with each other, the Russian Ministry of Communications and Information had already taken measures in 2003: A working group was commissioned by decree No. 161 to coordinate the TETRARUS project. The objective of this project is to provide the agencies with smooth and secure communications at all levels on the basis of TETRA technology. The solutions presented by Rohde & Schwarz were impressive.

ACCESSNET®-T mobile radio system recertified

The ACCESSNET®-T TETRA mobile radio system from R&S BICK Mobilfunk has again been recertified for interoperability (IOP). Since the system is continuously enhanced, official certification tests were again carried out in Bad Mündel at the end of last year.

ISCTI (Istituto Superiore delle Comunicazioni e delle Tecnologie dell'Informazione), which is the certification body of the Italian Communications Ministry and is accredited by the TETRA MoU Association, supervised and performed these tests. The tests lasted several weeks, during which all renowned manufacturers of TETRA terminals visited R&S BICK Mobilfunk's headquarters in Bad Mündel. The certificates and test results have been published on the TETRA MoU website and the Rohde & Schwarz Internet pages for general viewing. The multivendor principle within the TETRA standard is based on the IOP certification tests, which, in turn, substantiate this principle. R&S BICK Mobilfunk is an independent system supplier that is continuously developing system technology in accordance with the TETRA standard, as is evidenced by the company's history of passing the IOP certification tests on a regular basis.

Certification in accordance with ISO 17025 for Rohde & Schwarz USA

The Rohde & Schwarz calibration laboratory in Columbia, Maryland, has received A2LA accreditation for the ISO / IEC 17025 laboratory standard. ISO 17025 is an international standard for assessing the technical competency of calibration laboratories. Its practices help to ensure accurate data generation, controlled test methods, repeatable procedures, properly trained personnel and optimum management.

The certification marks an important milestone for Rohde & Schwarz. "This achievement ensures that our customers consistently receive tested and proven services that can only come from a laboratory carrying ISO 17025 accreditation," said Barry Fleming, the company's US service manager. ISO 17025 certification was accompanied by ANSI/NCL Z540 certification. For detailed information about A2LA accreditation, please visit [www.a2la.org](http://www.a2la.org).

Rohde & Schwarz Japan K.K. receives national award

Rohde & Schwarz Japan K.K. has received the Invest Japan Award from the Japanese Minister for Economics, Trade and Industry for its investment policy. The Invest Japan Award is given to foreign companies that help to further stimulate the Japanese economy by introducing new products and advanced technologies.

Rohde & Schwarz Japan K.K. was founded in Tokyo in 2003 as a Japanese subsidiary of Rohde & Schwarz. In May 2004, Rohde & Schwarz Japan K.K. established branch offices in Osaka and Shin-Yokohama for direct sales. In November 2004, a service center was set up in Saitama to provide technical support for the products. Another reason why Rohde & Schwarz Japan received the award is the company's rapidly growing share of the market in Japan.



Akihiko Yoshimura, Representative Director, and Günter Loll, Managing Director of Rohde & Schwarz Japan K.K., with the award.



## Nozema expands its DVB-T network with Rohde & Schwarz

**At the International Broadcasting Convention in Amsterdam, Rohde & Schwarz and the Dutch broadcast operator Nozema Services signed a contract for the delivery of DVB-T transmitters to be used to ensure nationwide DVB-T coverage of the Netherlands.**

At present, only the most densely populated western region has DVB-T coverage. To provide digital TV throughout the country, Nozema Services plans to install equipment at about 30 sites. In addition to the transmitters, Rohde & Schwarz will provide the liquid cooling system, combiners and antenna switching equipment. The transmitter systems will be installed in various transmitter towers of the Dutch telecom company KPN as well as of Novec, and in specially designed containers from Rohde & Schwarz as a turn-key solution.

## ILS/VOR analyzers for Norwegian air traffic control

**Within the scope of an invitation for tenders, AVINOR AS, the Norwegian air traffic control service provider, has decided to purchase 50 R&S®EVS300 ILS/VOR analyzers (ILS stands for instrument landing system, VOR for VHF omnidirectional range). AVINOR AS is responsible for checking terrestrial radio navigation equipment at approx. 50 airports throughout Norway.**

Regular maintenance of these systems using mobile analyzers is imperative for meeting the high safety standards required for instrument landing. Its measurement accuracy, compact size, wide range of functions

and optimized battery management make the R&S®EVS300 ideally suited for these requirements (see article on page 32). Considering all of its characteristics, this instrument is in a class of its own compared with the competitor products.

## Rohde & Schwarz and Freescale push HSDPA development

**Rohde & Schwarz and Freescale Semiconductor, a leading chip manufacturer, have successfully implemented video streaming via high-speed downlink packet access (HSDPA). In a trend-setting presentation made at the Freescale Technology Forum in Paris, the Freescale 3G Dual Core Modem i.300-30 platform and the Protocol Tester R&S®CRTU-W from Rohde & Schwarz were used.**

The Protocol Tester R&S®CRTU-W played an important role in the development at Freescale. The following options were also used: a test software for layer 1 implementations in WCDMA and HSDPA terminals, the official tree and tabular combined notation (TTCN) conformance test cases plus the R&S®CRTU-WT02 C++ programming interface. Freescale will use the R&S®TS8950 G/W test system for RF certification.

Rohde & Schwarz and Freescale are thus securing their leading role in the continued development of third-generation mobile radio.

## Rohde & Schwarz supplies the world's first T-DMB system in Korea

**Rohde & Schwarz has been commissioned to supply T-DMB transmitter systems for the world's first T-DMB network in Korea, where a number of network operators have started to set up T-DMB transmitter networks. All the transmitter equipment for this network was ordered from Rohde & Schwarz. The company has its own service and support center in Korea, which has been a special advantage.**

After a successful test phase with air-cooled transmitters from Rohde & Schwarz, the network operator KBS Korean Broadcasting System ordered liquid-cooled T-DMB transmitter systems with an output power of 1.4 kW and 2.3 kW for regular operation. Rohde & Schwarz also supplied further transmitters with air and liquid cooling for SBS (Seoul Broadcasting System), MBC and YTN. Installation will be completed by the end of 2005.

## GSM seminar in Pakistan

**About 12 million potential mobile radio users live in Pakistan – and the number is rising. Rohde & Schwarz invited members of Pakistan's government and representatives of mobile radio companies to a seminar about GSM networks to introduce its know-how to this country and its market.**

The focus was on the challenges that providers in Pakistan have to meet. In view of the rapidly increasing use of mobile radio, it is essential to promote the planning and expansion of the infrastructure.

Ahmed Jawad, Managing Director of Rohde & Schwarz Pakistan, emphasized the company's commitment and its investments in Pakistan. The demand for information about network coverage, installation and transmitter quality with base stations was very high, especially with regard to GSM/GPRS.

Rohde & Schwarz opened its own subsidiary in Pakistan in April 2005.

**Many members of Pakistan's government and representatives of mobile radio companies from Pakistan took part in the seminar on GSM networks.**





**ROHDE & SCHWARZ**

[www.rohde-schwarz.com](http://www.rohde-schwarz.com)

**Europe:** [customersupport@rohde-schwarz.com](mailto:customersupport@rohde-schwarz.com) · **North America:** [customer.support@rsa.rohde-schwarz.com](mailto:customer.support@rsa.rohde-schwarz.com) · **Asia:** [customersupport.asia@rohde-schwarz.com](mailto:customersupport.asia@rohde-schwarz.com)