

8

SMA **SMA**

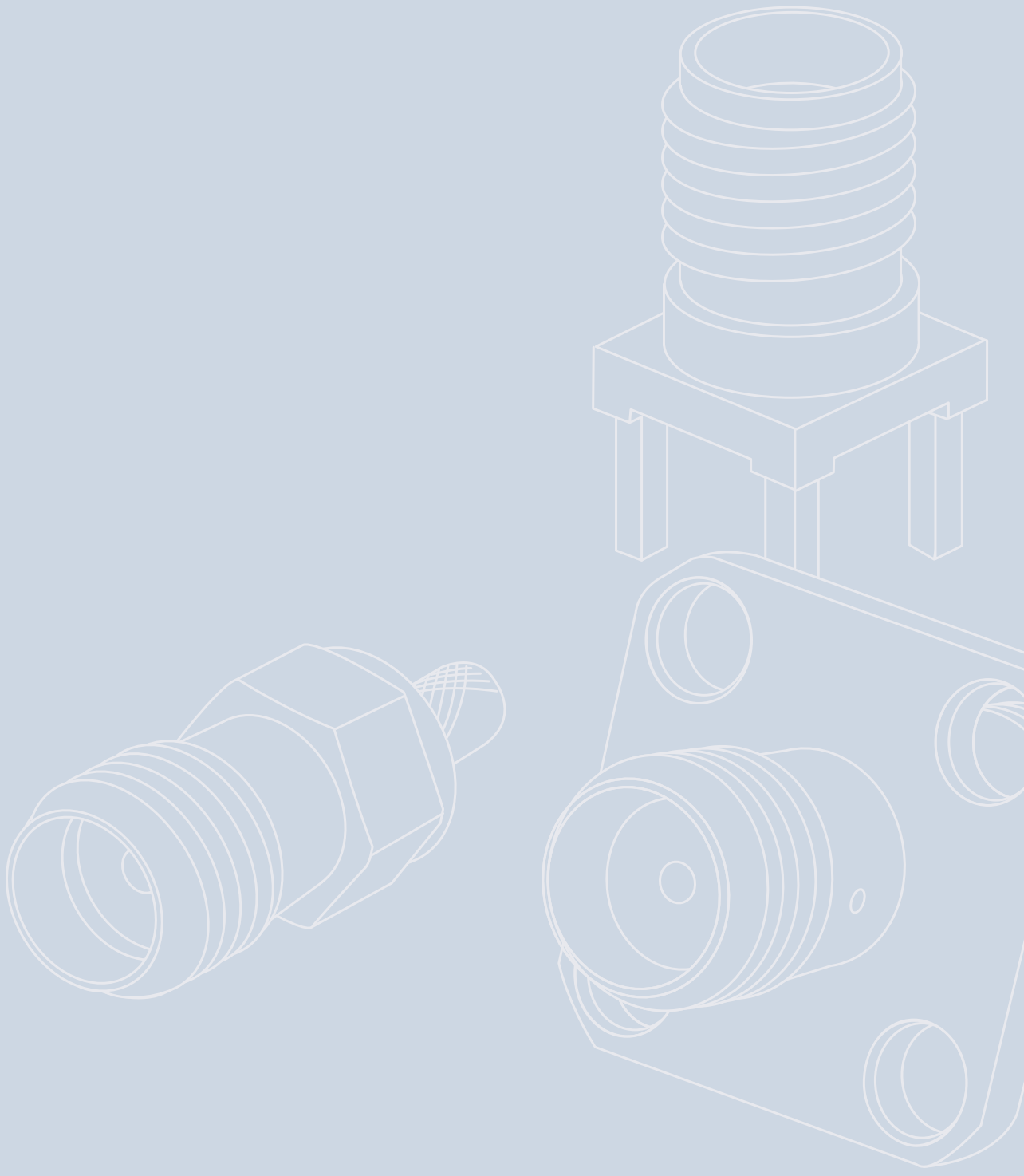



SMA SMA

- 8.1 SMA Straight Plug.....160
- 8.2 SMA Straight Plug Crimp160
- 8.3 SMA Angle Plug.....161
- 8.4 SMA Angle Plug Crimp162
- 8.5 SMA Panel Receptacle, male162
- 8.6 SMA Straight Jack.....163
- 8.7 SMA Straight Jack Crimp.....163
- 8.8 SMA Bulkhead Jack.....164
- 8.9 SMA Bulkhead Jack Crimp164
- 8.10 SMA Bulkhead Receptacle, female165
- 8.11 SMA Panel Socket.....167
- 8.12 SMA Angle Panel Socket.....169
- 8.13 SMA Receptacle, female,
for Printed Circuits in Press-In Technology169
- 8.14 SMA Receptacle, female, for Printed Circuits...170
- 8.15 SMA Angle Bulkhead Receptacle,
female, for Printed Circuits.....170
- 8.16 SMA Angle Receptacle, female,
for Printed Circuits171
- 8.17 SMA End Launcher for PCB171
- 8.18 SMA Edge-Mount Jack in SMT172
- 8.19 SMA-Edge-Mount Bulkhead Receptacle,
female, in SMT.....172
- 8.20 SMA Adaptor.....172
- 8.21 SMA Angle Adaptor.....173
- 8.22 SMA Bulkhead Adaptor173
- 8.23 SMA Panel Adaptor174
- 8.24 SMA T Adaptor.....174
- 8.25 SMA Surge Suppressor.....175
- 8.26 SMA Dust Cap175
- 8.27 SMA Termination Plug176

- 8.1 SMA-Kabelstecker.....160
- 8.2 SMA-Kabelstecker Crimp.....160
- 8.3 SMA-Kabelwinkelstecker.....161
- 8.4 SMA-Kabelwinkelstecker Crimp.....162
- 8.5 SMA-Einbaustecker mit Flansch162
- 8.6 SMA-Kabelbuchse.....163
- 8.7 SMA-Kabelbuchse Crimp.....163
- 8.8 SMA-Kabeleinbaubuchse164
- 8.9 SMA-Kabeleinbaubuchse Crimp164
- 8.10 SMA-Einbaubuchse.....165
- 8.11 SMA-Einbaubuchse mit Flansch.....167
- 8.12 SMA-Winkeleinbaubuchse mit Flansch169
- 8.13 SMA-Buchse für gedruckte Schaltungen
in Einpresstechnik169
- 8.14 SMA-Buchse für gedruckte Schaltungen170
- 8.15 SMA-Winkeleinbaubuchse für
gedruckte Schaltungen170
- 8.16 SMA-Winkelbuchse für gedruckte
Schaltungen.....171
- 8.17 SMA-End-Launch Buchse für Leiterplatten171
- 8.18 SMA-Edge-Mount Buchse in SMT172
- 8.19 SMA-Edge-Mount Einbaubuchse in SMT172
- 8.20 SMA-Kupplung172
- 8.21 SMA-Winkelkupplung173
- 8.22 SMA-Verbindungsstück.....173
- 8.23 SMA-Einbaukupplung mit Flansch.....174
- 8.24 SMA-T-Stück174
- 8.25 SMA Überspannungsableiter.....175
- 8.26 SMA-Abdeckkappe175
- 8.27 SMA-Abschlusswiderstand176

The SMA series is a very popular coax connector with threaded coupling, and can be used up to frequencies of over 18 GHz (depending on type). The impedance is controlled at 50 Ω. Connector styles are available for flexible, conformable and semi-rigid cable types. Versions of the SMA connector are available for mounting to printed circuit boards using both through-hole soldered and through-hole press-fit techniques, as well as surface mount types (SMD). Solder, crimp and clamp techniques are used to terminate this series to cables. SMA applications include communications, satellite and test equipment.

Mating face sealing for SMA connectors between plug and jack (mated) according to IP 68. This classification is a general statement for the relevant series. Individual connectors may deviate from the values shown. If in doubt, please consult our engineers.

Die Serie SMA umfasst sehr häufig verwendete koaxiale Steckverbindungen mit Schraubverschluss. Sie können je nach Ausführung bis zu einer Frequenz von 18 GHz eingesetzt werden. Der Wellenwiderstand beträgt 50 Ω. Steckverbindervarianten gibt es für flexible, Semi-Flex- und Semi-Rigid-Kabel. Die Leiterplattensteckverbinder der Serie SMA sind als Löt- bzw. Einpresstypen erhältlich. Kabel werden je nach Ausführung durch Crimpen, Klemmen oder Löten angeschlossen. SMA-Steckverbinder werden unter anderem im Mobilfunk, in Satelliten und in der Meßtechnik eingesetzt.

Diese Steckverbinder erfüllen die Querdichtigkeit im Steckgesicht zwischen Stecker und Buchse im gesteckten Zustand gemäß IP 68. Diese Schutzklasse ist pauschal für die Serie SMA festgelegt worden. Für einzelne Steckverbindungen kann es zu Abweichungen kommen. Im Zweifelsfall bitte anfragen.

Mechanical Characteristics

Durability (mating cycles).....	≥ 500	Lebensdauer (Steckungen)
Recommended coupling torque79 - 113 Ncm	Empfohlenes Kupplungsdrehmoment
Material: Spring contacts	CuBe2	Werkstoff: Federnde Kontaktteile
Material: Solid contact parts standard type.....	CuZn39Pb3	Werkstoff: Nichtfedernde Kontaktteile Standard-Ausführung
Material: Solid contact parts MIL-type (stainless steel).....	1.4305	Werkstoff: Nichtfedernde Kontaktteile MIL-Ausführung (Edelstahl)
Material: Crimp ferrule.....	Cu	Werkstoff: Crimprohr
Material: Serrated lock washer	CuSn6	Werkstoff: Fächerscheibe
Material: Insulators.....	PTFE	Werkstoff: Isolierteile
Material: Gaskets.....	Silicone	Werkstoff: Dichtungen
Finish: Inner conductor	Cu1Ni2Au1.27	Oberfläche: Innenleiter
Finish outer conductor: Gold plated (standard; last digit ...1).....	Cu1Ni2Au0.8; NiPAu	Oberfläche Außenleiter: Gold beschichtet (Standard; Endziffer ...1)
Finish outer conductor: MIL gold plated (last digit ...2).....	Cu1Ni2Au1.27	Oberfläche Außenleiter: MIL Gold beschichtet (Endziffer ...2)
Finish outer conductor: Stainless steel (last digit ...6).....	passivated / passiviert	Oberfläche Außenleiter: Edelstahl (MIL-Ausführung; Endziffer ...6)
Finish outer conductor: Type for printed circuits (last digit ...7)	SnPb8	Oberfläche Außenleiter: Leiterplatten-Ausführung (Endziffer ...7)
Finish outer conductor: Telealloy (white bronze) plated (last digit ...8)	CuSnZn3	Oberfläche Außenleiter: Telealloy beschichtet (Endziffer ...8)
Finish outer conductor: Nickel plated (last digit ...9).....	Cu2Ni5	Oberfläche Außenleiter: Nickel beschichtet (Endziffer ...9)
Finish other metal parts: Gold plated (standard; last digit ...1).....	Cu2Ni5Au0.2	Oberfläche sonstiger Metallteile: Gold beschichtet (Standard; Endziffer ...1)
Finish other metal parts: MIL gold plated (last digit ...2).....	Cu1Ni2Au0.8	Oberfläche sonstiger Metallteile: MIL Gold beschichtet (Endziffer ...2)
Finish other metal parts: Stainless steel (MIL type; last digit ...6).....	passivated / passiviert	Oberfläche sonstiger Metallteile: Edelstahl (MIL-Ausführung; Endziffer ...6)
Finish other metal parts: Telealloy (white bronze) plated (last digit...8)	CuSnZn3	Oberfläche sonstiger Metallteile: Telealloy beschichtet (Endziffer ...8)
Finish other metal parts: Nickel plated (last digit ...9)	Cu2Ni5	Oberfläche sonstiger Metallteile: Nickel beschichtet (Endziffer ...9)
RoHS compliant	RoHS konform

Mechanische Eigenschaften

Climatic Characteristics

Climatic category acc. to IEC 60068 - 1	55/155/56.....	Prüfklasse nach DIN IEC 60068 Teil 1
---	----------------	--------------------------------------

Thermische und klimatische Eigenschaften

Electrical Characteristics

Impedance.....	50 Ω	Wellenwiderstand
Voltage proof.....	1 kV/50 Hz	Spannungsfestigkeit
Working voltage	≤ 335 V/50 Hz.....	Betriebsspannung
Contact resistance inner conductor.....	≤ 3 mΩ	Durchgangswiderstand Innenleiter
Contact resistance outer conductor.....	≤ 2 mΩ	Durchgangswiderstand Außenleiter
Insulation resistance.....	≥ 5 GΩ	Isolationswiderstand
Frequency range for flexible cable up to	12.4 GHz.....	Frequenzbereich für flexible Kabel bis
Frequency range for semi-rigid cable up to (Straight style).....	18.0 GHz.....	Frequenzbereich für Festmantelkabel bis (Gerade Ausführung)
Frequency range for semi-rigid cable up to (Angle style).....	12.4 GHz.....	Frequenzbereich für Festmantelkabel bis (Winkel Ausführung)
Return loss flexible cable (straight and angle style) at 1 GHz.....	≥ 20.0 dB	Rückflussdämpfung Flexible Kabel (Gerade / Winkel Ausführung) bei 1 GHz
Return loss flexible cable (straight and angle style) at 2 GHz.....	≥ 19.2 dB	Rückflussdämpfung Flexible Kabel (Gerade / Winkel Ausführung) bei 2 GHz
Return loss flexible cable (straight and angle style) at 4 GHz.....	≥ 17.7 dB	Rückflussdämpfung Flexible Kabel (Gerade / Winkel Ausführung) bei 4 GHz
Return loss flexible cable (straight and angle style) at 6 GHz.....	≥ 16.5 dB	Rückflussdämpfung Flexible Kabel (Gerade / Winkel Ausführung) bei 6 GHz
Return loss semi-rigid cable (straight style) at 1 GHz.....	≥ 28.5 dB	Rückflussdämpfung Festmantelkabel (Gerade Ausführung) bei 1 GHz
Return loss semi-rigid cable (straight style) at 2 GHz.....	≥ 27.0 dB	Rückflussdämpfung Festmantelkabel (Gerade Ausführung) bei 2 GHz
Return loss semi-rigid cable (straight style) at 4 GHz.....	≥ 26.0 dB	Rückflussdämpfung Festmantelkabel (Gerade Ausführung) bei 4 GHz
Return loss semi-rigid cable (straight style) at 6 GHz.....	≥ 24.9 dB	Rückflussdämpfung Festmantelkabel (Gerade Ausführung) bei 6 GHz
Return loss semi-rigid cable (angle style) at 1 GHz.....	≥ 25.7 dB	Rückflussdämpfung Festmantelkabel (Winkel Ausführung) bei 1 GHz
Return loss semi-rigid cable (angle style) at 2 GHz.....	≥ 25.2 dB	Rückflussdämpfung Festmantelkabel (Winkel Ausführung) bei 2 GHz
Return loss semi-rigid cable (angle style) at 4 GHz.....	≥ 24.2 dB	Rückflussdämpfung Festmantelkabel (Winkel Ausführung) bei 4 GHz
Return loss semi-rigid cable (angle style) at 6 GHz.....	≥ 23.2 dB	Rückflussdämpfung Festmantelkabel (Winkel Ausführung) bei 6 GHz

Elektrische Eigenschaften

Standards

IEC 60 169-15

The Return Loss values shown above correspond to the IEC Standard 60 169-15. In most cases, the RF connectors from Telegärtner fulfill or exceed these requirements. Depending on the design and cable type, however, particular connectors could deviate from the norm. The exact parameters of individual products are available upon request.

Finish types

Type.....	Last Digit	Endziffer.....	Ausführung
Gold (Standard)	1	Gold (Standard)
MIL-gold.....	2	MIL-Gold
Silver plated.....	4	Silber beschichtet
Stainless steel, passivated (MIL type)	6	Edelstahl, passiviert (MIL-Ausführung)
Type for printed circuits (tinned terminal).....	7	Leiterplatten-Ausführung (verzinnter Lötanschluss)
Telealloy (white bronze)	8	Telealloy
Nickel	9	Nickel

Versions with last digits 1, 8 and 9 are available as standard. Those with last digits 2, 4, 6 and 7 can be manufactured when a defined minimum quantity is ordered.

Die oben angeführten Rückflussdämpfungswerte entsprechen der IEC-Norm 60 169-15. Die Telegärtner-Steckverbinder erfüllen oder übertreffen in den meisten Fällen diese Normwerte. Je nach Ausführung und Kabeltype können einzelne Steckverbinder jedoch abweichen. Die genauen Parameter der einzelnen Produkte sind auf Anfrage erhältlich.

Oberflächen-Ausführungen

Als Standard werden die Typen mit den Endziffern 1 und 8 bzw. 9 angeboten. Die Typen mit den Endziffern 2, 4, 6 und 7 können auf Anfrage bei Einhaltung einer Mindestbestellmenge geliefert werden.

Normen

IEC 60 169-15

SMA Mating Face SMA-Steckgesicht

Plug
Stecker

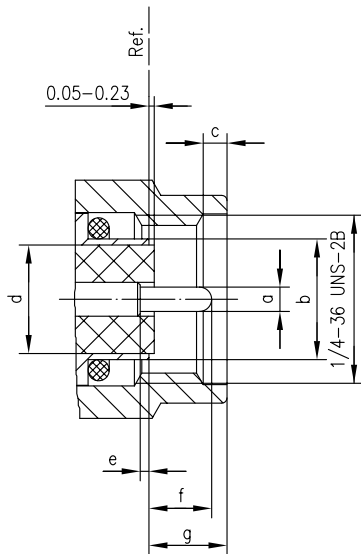

	[inch]		[mm]	
	min.	max.	min.	max.
a	0.035	0.037	0.902	0.940
b	-	0.181	-	4.59
c	0.015	0.045	0.38	1.14
d	-	0.165	-	4.178
e	0.0	-	0.0	-
f	-	0.100	-	2.54
g	-	0.135	-	3.43
h	-	0.135	-	3.43

Jack
Buchse

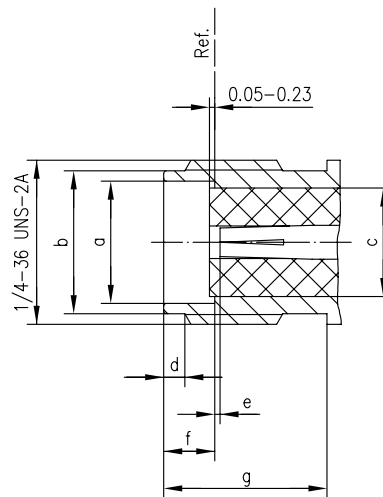

	[inch]		[mm]	
	min.	max.	min.	max.
a	0.181	0.184	4.60	4.67
b	0.208	0.216	5.28	5.49
c	-	0.165	-	4.178
d	0.015	0.045	0.38	1.14
e	0.0	0.016	0.0	0.41
f	0.074	0.078	1.88	1.98
g	0.218	-	5.54	-
h	0.218	-	5.54	-

8.1

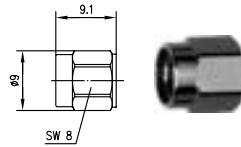
SMA Straight Plug
SMA-Kabelstecker

Order No. Bestell-Nr.	Cable group; cable Kabelgruppe; Kabel	Finish Oberfläche	Remarks Anmerkungen	Assembly Montage
J01150B0111	G10 (UT-141)	Gold	without inner conductor IP 68 ohne Innenleiter, IP 68	C28
J01150A0118	G10 (UT-141)	Tealloy (white bronze)	without inner conductor IP 68 ohne Innenleiter, IP 68	C16

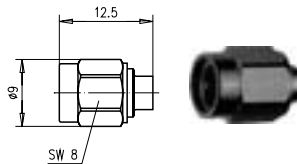

Order No. Bestell-Nr.	Cable group; cable Kabelgruppe; Kabel	Finish Oberfläche	Remarks Anmerkungen	Assembly Montage
J01150A0121	G11 (UT-85)	Gold	with inner conductor IP 68 mit Innenleiter, IP 68	C01
J01150A0131	G10 (UT-141)	Gold	with inner conductor IP 68 mit Innenleiter, IP 68	C01

8.2

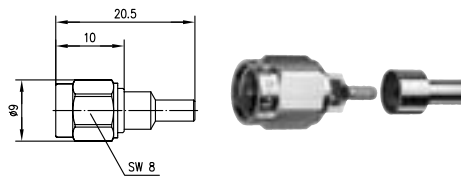
SMA Straight Plug Crimp
SMA-Kabelstecker Crimp

Order No. Bestell-Nr.	Cable group; cable Kabelgruppe; Kabel	Finish Oberfläche	Remarks Anmerkungen	Assembly Montage	Crimp die Crimpeinsatz
J01150A0601	G3 (RG-178B/U)	Gold	solder/crimp; >17 dB/2 GHz; >12 dB/4 GHz löt/crimp; >17 dB/2 GHz; >12 dB/4 GHz	C1013	N01001A0009

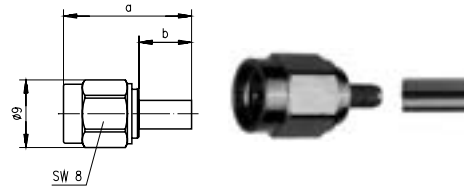

Order No. Bestell-Nr.	Cable group; cable Kabelgruppe; Kabel	Finish Oberfläche	Remarks Anmerkungen	Dimensions Abmessungen	Assembly Montage	Crimp die Crimpeinsatz
J01150A0011	G7 (RG-316/U)	Gold	solder/crimp löt/crimp	a=17, b=7	C0103	N01001A0009
J01150A0018	G7 (RG-316/U)	Telealloy (white bronze)	solder/crimp löt/crimp	a=17, b=7	C0103	N01001A0009
J01150A0019	G7 (RG-316/U)	Nickel	solder/crimp löt/crimp	a=17, b=7	C0103	N01001A0009
J01150A0021	G8 (RD-316)	Gold	solder/crimp löt/crimp	a=17, b=7	C0114	N01001A0014
J01150A0028	G8 (RD-316)	Telealloy (white bronze)	solder/crimp löt/crimp	a=17, b=7	C0114	N01001A0014
J01150A0029	G8 (RD-316)	Nickel	solder/crimp löt/crimp	a=17, b=7	C0114	N01001A0014
J01150A0041	G1 (RG-58C/U)	Gold	solder/crimp löt/crimp	a=23.3, b=13	C0105	N01001A0005
J01150A0049	G1 (RG-58C/U)	Nickel	solder/crimp löt/crimp	a=23.3, b=13	C0105	N01001A0005
J01150A0031	G5 (RG-223/U); RG-142B/U	Gold	solder/crimp löt/crimp	a=23.8, b=13.5	C0105	N01001A0005
J01150A0038	G5 (RG-223/U); RG-142B/U	Telealloy (white bronze)	solder/crimp löt/crimp	a=23.8, b=13.5	C0105	N01001A0005
J01150A0039	G5 (RG-223/U); RG-142B/U	Nickel	solder/crimp löt/crimp	a=23.8, b=13.5	C0105	N01001A0005

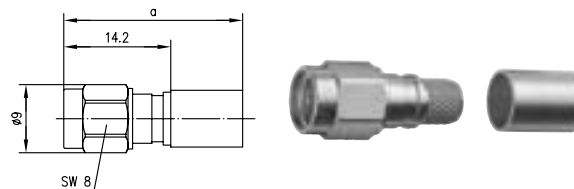

Order No. Bestell-Nr.	Cable group; cable Kabelgruppe; Kabel	Finish Oberfläche	Remarks Anmerkungen	Dimensions Abmessungen	Assembly Montage	Crimp die Crimpeinsatz
J01150A0641	G44 (1.1/2.95)	Gold	crimp/crimp	a=27.2	C2705	N01001A0005
J01150A0611	G30 (1.5/3.8)	Gold	crimp/crimp	a=23.7	C2731	N01001A0056
J01150A0618	G30 (1.5/3.8)	Telealloy (white bronze)	crimp/crimp	a=23.7	C2731	N01001A0056

SMA Angle Plug SMA-Kabelwinkelstecker

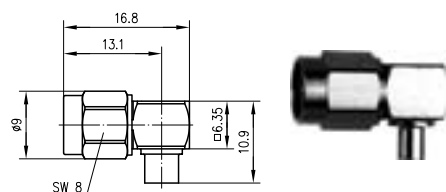

Order No. Bestell-Nr.	Cable group; cable Kabelgruppe; Kabel	Finish Oberfläche	Remarks Anmerkungen	Assembly Montage
J01150A0141	G11 (UT-85)	Gold	>34 dB/1 GHz; >30 dB/2 GHz; >24 dB/4GHz	C02
J01150A0151	G10 (UT-141)	Gold	>39 dB/1 GHz; >35 dB/2 GHz; >30 dB/4 GHz	C02

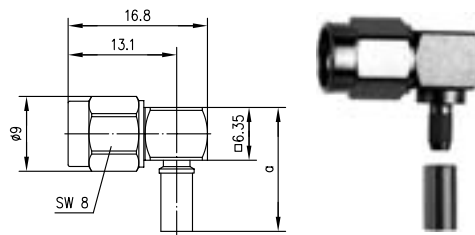
SMA Angle Plug Crimp
SMA-Kabelwinkelstecker Crimp

Order No. Bestell-Nr.	Cable group; cable Kabelgruppe; Kabel	Finish Oberfläche	Remarks Anmerkungen	Dimensions Abmessungen	Crimp die Crimpeinsatz	Assembly Montage
J01150A0541	G3 (RG-178B/U)	Gold		a=14.9	N01001A0010	C0413
J01150A0549	G3 (RG-178B/U)	Nickel		a=14.9	N01001A0010	C0413
J01150A0061	G7 (RG-316/U)	Gold	>29 dB/1 GHz; >24.5 dB/ 2 GHz; >21 dB/4 GHz	a=14.9	N01001A0009	C0403
J01150A0068	G7 (RG-316/U)	Tealloy (white bronze)	>29 dB/1 GHz; >24.5 dB/ 2 GHz; >21 dB/4 GHz	a=14.9	N01001A0009	C0403
J01150A0069	G7 (RG-316/U)	Nickel	>29 dB/1 GHz; >24.5 dB/ 2 GHz; >21 dB/4 GHz	a=14.9	N01001A0009	C0403
J01150A0071	G8 (RD-316)	Gold	>33 dB/1 GHz; 28.5 dB/ 2 GHz; 25 dB/4GHz	a=14.9	N01001A0014	C0414
J01150A0078	G8 (RD-316)	Tealloy (white bronze)	>33 dB/1 GHz; 28.5 dB/ 2 GHz; 25 dB/4GHz	a=14.9	N01001A0014	C0414
J01150A0079	G8 (RD-316)	Nickel	>33 dB/1 GHz; 28.5 dB/ 2 GHz; 25 dB/4GHz	a=14.9	N01001A0014	C0414
J01150A0091	G1 (RG-58C/U); 1.0/2.95 AF	Gold	>39 dB/1 GHz; >35 dB/ 2 GHz; >28 dB/4 GHz	a=20.9	N01001A0005	C0405
J01150A0099	G1 (RG-58C/U); 1.0/2.5 AF	Nickel	>39 dB/1 GHz; >35 dB/ 2 GHz; >28 dB/4 GHz	a=20.9	N01001A0005	C0405
J01150A0081	G5 (RG-223/U); RG-142B/U; 1.0/2.95 AF	Gold	>39 dB/1 GHz; >35 dB/ 2 GHz; >28 dB/4 GHz	a=21.4	N01001A0005	C0405
J01150A0088	G5 (RG-223/U); RG-142B/U; 1.0/2.95 AF	Tealloy (white bronze)	>39 dB/1 GHz; >35 dB/ 2 GHz; >28 dB/4 GHz	a=21.4	N01001A0005	C0405
J01150A0089	G5 (RG-223/U); RG-142B/U; 1.0/2.95 AF	Nickel	>39 dB/1 GHz; >35 dB/ 2 GHz; >28 dB/4 GHz	a=21.4	N01001A0005	C0405
J01150A0521	G30 (1.5/3.8); LMR-240	Gold		a=21.9	N01001A0056	C0431

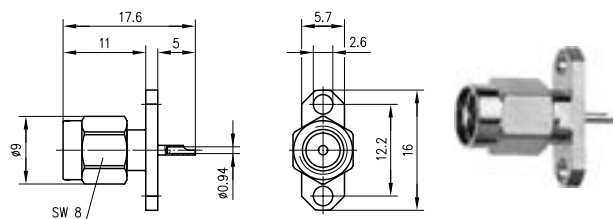
SMA Panel Receptacle, male
SMA-Einbaustecker mit Flansch

Order No. Bestell-Nr.	Finish Oberfläche	Mount. dim. Einbaumaß
J01150A0161	Gold	Z28

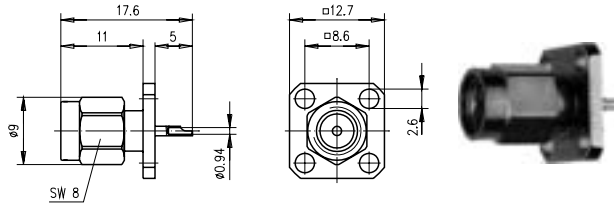

Order No. Bestell-Nr.	Finish Oberfläche	Mount. dim. Einbaumaß
J01150A0191	Gold	Z29

SMA Straight Jack
SMA-Kabelbuchse

8.6

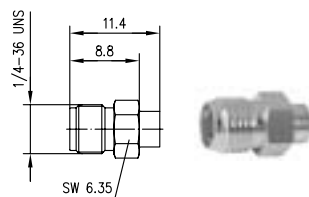

Order No. Bestell-Nr.	Cable group; cable Kabelgruppe; Kabel	Finish Oberfläche	Assembly Montage
J01151A1181	G10 (UT-141)	Gold	C27

SMA Straight Jack Crimp
SMA-Kabelbuchse Crimp

8.7

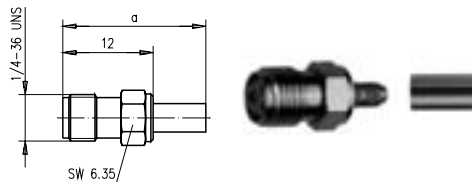

Order No. Bestell-Nr.	Cable group; cable Kabelgruppe; Kabel	Finish Oberfläche	Dimensions Abmessungen	Assembly Montage	Crimp die Crimpeinsatz
J01151A0051	G7 (RG-316/U)	Gold	a=19	C0703	N01001A0009
J01151A0058	G7 (RG-316/U)	Tealloy (white bronze)	a=19	C0703	N01001A0009
J01151A0059	G7 (RG-316/U)	Nickel	a=19	C0703	N01001A0009
J01151A0351	G8 (RD-316)	Gold	a=19	C0714	N01001A0014
J01151A0491	G1 (RG-58C/U)	Gold	a=25	C0705	N01001A0005
J01151A0611	G5 (RG-223/U); RG-142B/U	Gold	a=25.5	C0705	N01001A0005

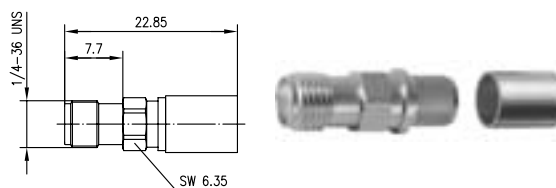

Order No. Bestell-Nr.	Cable group; cable Kabelgruppe; Kabel	Finish Oberfläche	Assembly Montage	Crimp die Crimpeinsatz
J01151A1061	G30 (1.5/3.8)	Gold	C2731	N01001A0056

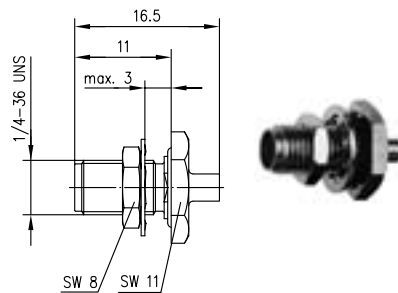
SMA Bulkhead Jack
SMA-Kabeleinbaubuchse

Order No. Bestell-Nr.	Cable group; cable Kabelgruppe; Kabel	Finish Oberfläche	Remarks Anmerkungen	Mount. dim. Einbaumaß	Assembly Montage
J01151A0061	G11 (UT-85)	Gold	with panel seal IP 68 mit Dichtring IP 68	Z27	C18
J01151A0911	G10 (UT-141)	Gold	with panel seal IP 68 mit Dichtring IP 68	Z27	C18

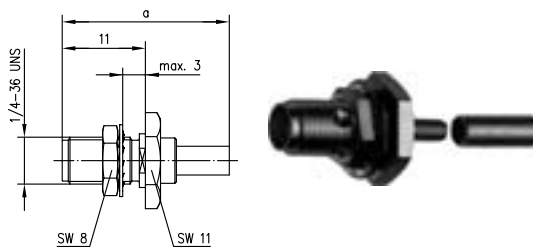
SMA Bulkhead Jack Crimp
SMA-Kabeleinbaubuchse Crimp

Order No. Bestell-Nr.	Cable group; cable Kabelgruppe; Kabel	Finish Oberfläche	Remarks Anmerkungen	Dimensions Abmessungen	Mount. dim. Einbaumaß	Assembly Montage	Crimp die Crimpeinsatz
J01151A0001	G7 (RG-316/U)	Gold		a=22	Z27	C0803	N01001A0009
J01151A0009	G7 (RG-316/U)	Nickel		a=22	Z27	C0803	N01001A0009
J01151A0541	G7 (RG-316/U)	Gold	with panel seal IP 68 mit Dichtring IP 68	a=22	Z27	C0803	N01001A0009
J01151A0549	G7 (RG-316/U)	Nickel	with panel seal IP 68 mit Dichtring IP 68	a=22	Z27	C0803	N01001A0009
J01151A0221	G8 (RD-316)	Gold		a=22	Z27	C0814	N01001A0014
J01151A0229	G8 (RD-316)	Nickel		a=22	Z27	C0814	N01001A0014
J01151A0601	G8 (RD-316)	Gold	with panel seal mit Dichtring	a=22	Z27	C0814	N01001A0014
J01151A0401	G1 (RG-58C/U)	Gold		a=26	Z27	C0805	N01001A0005
J01151A0408	G1 (RG-58C/U)	Tealloy (white bronze)		a=26	Z27	C0805	N01001A0005
J01151A0409	G1 (RG-58C/U)	Nickel		a=26	Z27	C0805	N01001A0005
J01151A1091	G1 (RG-58C/U)	Gold	with panel seal IP 68 mit Dichtring IP 68	a=26	Z27	C0805	N01001A0005
J01151A0011	G5 (RG-223/U); RG-142B/U	Gold		a=26.5	Z27	C0805	N01001A0005
J01151A0019	G5 (RG-223/U); RG-142B/U	Nickel		a=26.5	Z27	C0805	N01001A0005
J01151A1111	G30 (1.5/3.8)	Gold	with panel seal mit Dichtring	A= 22.85	Z27	C2731	N01001A0056

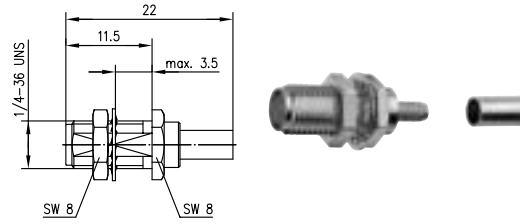

Order No. Bestell-Nr.	Cable group; cable Kabelgruppe; Kabel	Finish Oberfläche	Mount. dim. Einbaumaß	Assembly Montage
J01151A0671	G7 (RG-316/U)	Gold	Z36	C0803

SMA Bulkhead Receptacle, female
SMA-Einbaubuchse

8.10

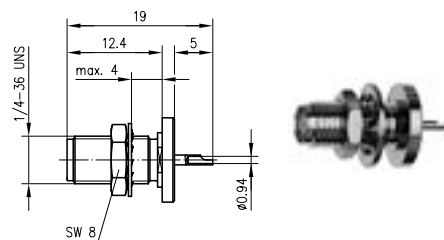

Order No. Bestell-Nr.	Finish Oberfläche	Remarks Anmerkungen	Mount. dim. Einbaumaß
J01151A0021	Gold	rear mounting Einbau von hinten	Z27
J01151A0031	Gold	rear mounting with panel seal Einbau von hinten mit Dichtring	Z27

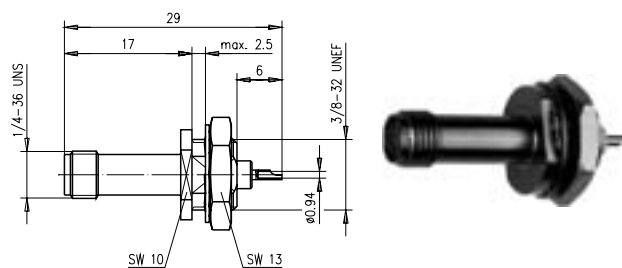

Order No. Bestell-Nr.	Finish Oberfläche	Remarks Anmerkungen	Mount. dim. Einbaumaß
J01151A0471	Gold	front mounting Einbau von vorne	Z01
J01151A0479	Nickel	front mounting Einbau von vorne	Z01

8.10

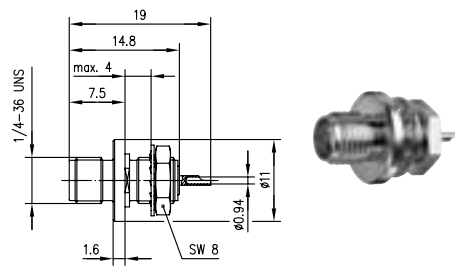
SMA Bulkhead Receptacle, female
SMA-Einbaubuchse

Order No. Bestell-Nr.	Finish Oberfläche	Remarks Anmerkungen	Mount. dim. Einbaumaß
J01151A1071	Gold	front mounting Einbau von vorne	Z27
J01151A1081	Gold	front mounting with panel seal Einbau von vorne mit Dichtring	Z27

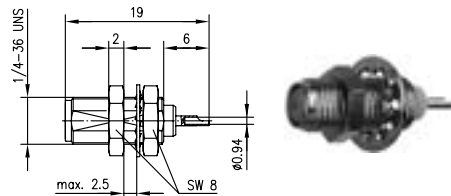

Order No. Bestell-Nr.	Finish Oberfläche	Mount. dim. Einbaumaß
J01151A0531	Gold	Z36

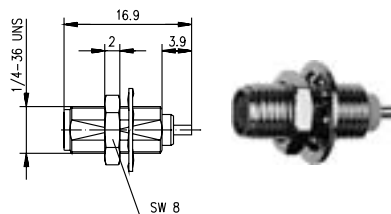

Order No. Bestell-Nr.	Finish Oberfläche	Mount. dim. Einbaumaß
J01151A0741	Gold	Z36

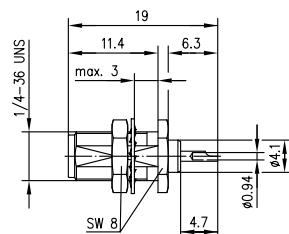

Order No. Bestell-Nr.	Finish Oberfläche	Mount. dim. Einbaumaß
J01151A0891	Gold	Z36

SMA Panel Socket
SMA-Einbaubuchse mit Flansch

8.11

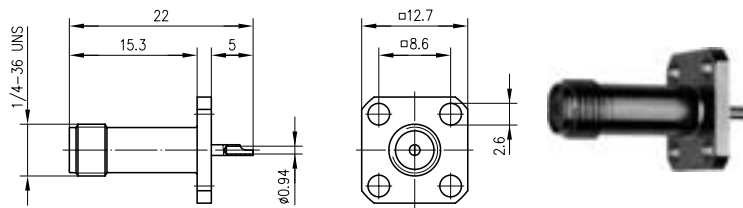

Order No. Bestell-Nr.	Finish Oberfläche	Mount. dim. Einbaumaß
J01151A0161	Gold	Z29
J01151A0169	Nickel	Z29

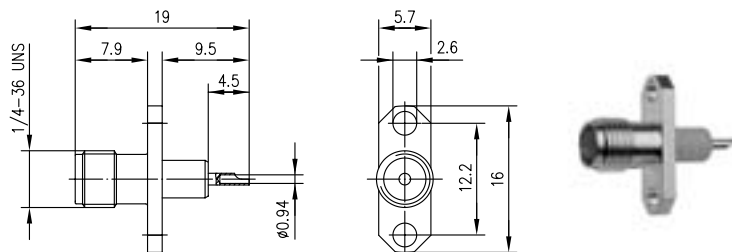

Order No. Bestell-Nr.	Finish Oberfläche	Mount. dim. Einbaumaß
J01151A0151	Gold	Z28
J01151A0159	Tealloy (white bronze)	Z28

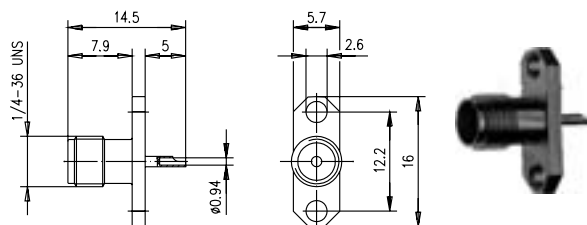

Order No. Bestell-Nr.	Finish Oberfläche	Mount. dim. Einbaumaß
J01151A0141	Gold	Z28
J01151A0149	Nickel	Z28

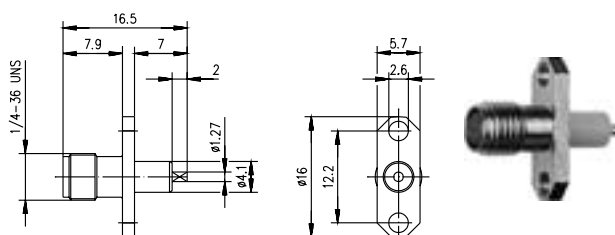

Order No. Bestell-Nr.	Finish Oberfläche	Mount. dim. Einbaumaß
J01151A0721	Gold	Z28

8.11

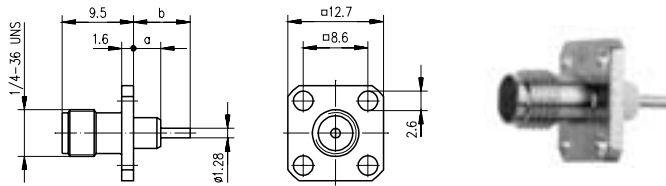
SMA Panel Socket
SMA-Einbaubuchse mit Flansch

Order No. Bestell-Nr.	Finish Oberfläche	Dimensions Abmessungen	Mount. dim. Einbaumaß
J01151A0621	Gold	a=3.6, b=7.5	Z29
J01151A0641	Gold	a=18, b=20.5	Z29

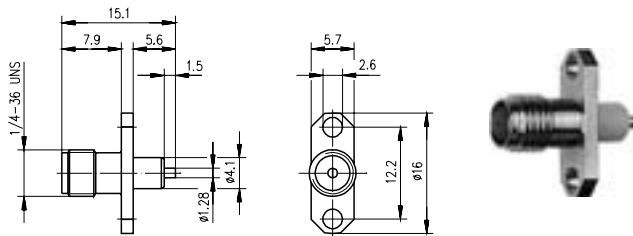

Order No. Bestell-Nr.	Finish Oberfläche	Mount. dim. Einbaumaß
J01151A0631	Gold	Z28

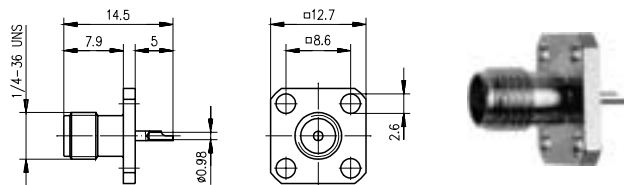

Order No. Bestell-Nr.	Finish Oberfläche	Mount. dim. Einbaumaß
J01151A0811	Gold	Z29

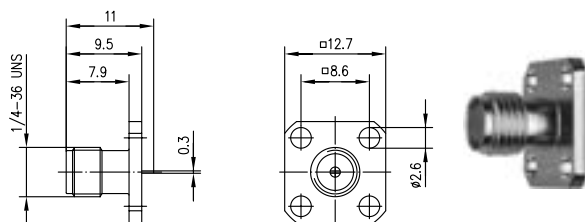

Order No. Bestell-Nr.	Finish Oberfläche	Mount. dim. Einbaumaß
J01151A0851	Gold	Z29

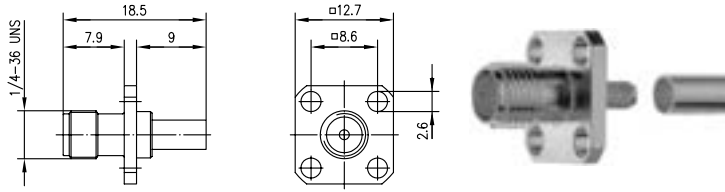

Order No. Bestell-Nr.	Cable group; cable Kabelgruppe; Kabel	Finish Oberfläche	Mount. dim. Einbaumaß	Assembly Montage	Crimp die Crimpeinsatz
J01151A1011	G7 (RG-316/U)	Gold	Z29	C0703	N01001A0009

SMA Angle Panel Socket
SMA-Winkeleinbaubuchse mit Flansch

8.12

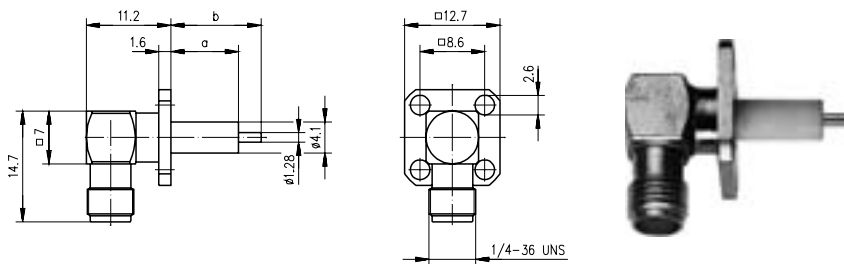

Order No. Bestell-Nr.	Finish Oberfläche	Remarks Anmerkungen	Dimensions Abmessungen	Mount. dim. Einbaumaß
J01151A0651	Gold		a=9, b=12	Z29
J01151A1141	Gold	with panel seal mit Dichtring	a=17, b=20	Z29

SMA Receptacle, female, for Printed Circuits in Press-In Technology
SMA-Buchse für gedruckte Schaltungen in Einpresstechnik

8.13

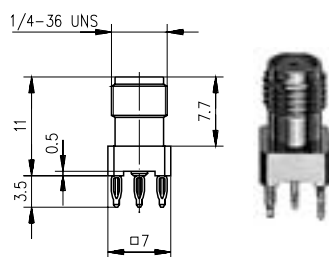

Order No. Bestell-Nr.	Finish Oberfläche	Remarks Anmerkungen	Mount. dim. Einbaumaß
J01151A0331	Gold	Further technical information on request Weitere technische Informationen auf Anfrage	Z78

SMA Receptacle, female, for Printed Circuits SMA-Buchse für gedruckte Schaltungen

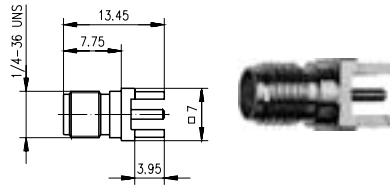

Order No. Bestell-Nr.	Finish Oberfläche	Mount. dim. Einbaumaß
J01151A0931	Gold	Z79
J01151A0938	Tealloy (white bronze)	Z79

SMA Angle Bulkhead Receptacle, female, for Printed Circuits SMA-Winkeleinbaubuchse für gedruckte Schaltungen

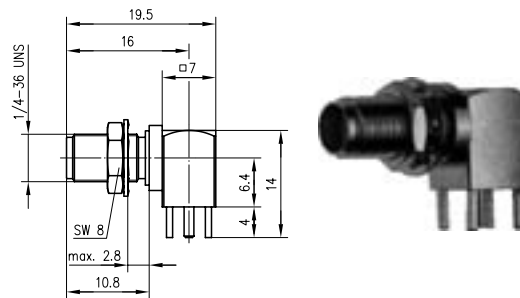

Order No. Bestell-Nr.	Finish Oberfläche	Mount. dim. Einbaumaß
J01151A0201	Gold	Z25/Z55
J01151A0208	Tealloy (white bronze)	Z25/Z55

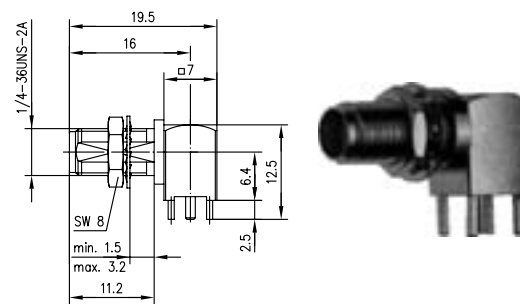

Order No. Bestell-Nr.	Finish Oberfläche	Mount. dim. Einbaumaß
J01151A0821	Gold	Z25/Z36

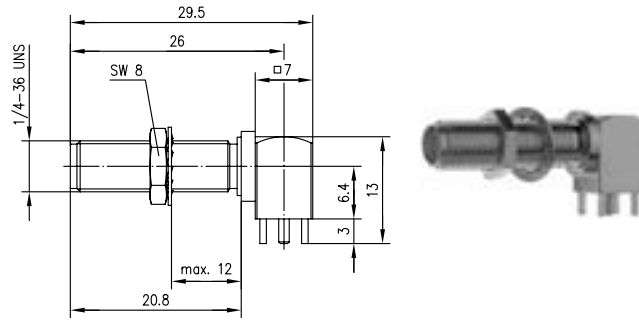

Order No. Bestell-Nr.	Finish Oberfläche	Mount. dim. Einbaumaß
J01151A0921	Gold	Z25/Z55

SMA Angle Receptacle, female, for Printed Circuits
SMA-Winkelbuchse für gedruckte Schaltungen

8.16

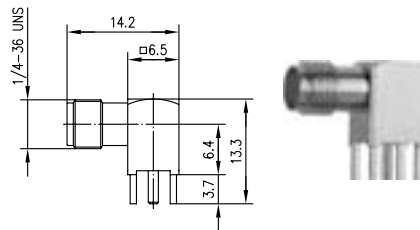

Order No. Bestell-Nr.	Finish Oberfläche	Mount. dim. Einbaumaß
J01151A0191	Gold	Z25
J01151A0198	Tealalloy (white bronze)	Z25

SMA End Launcher for PCB
SMA-End-Launch Buchse für Leiterplatten

8.17

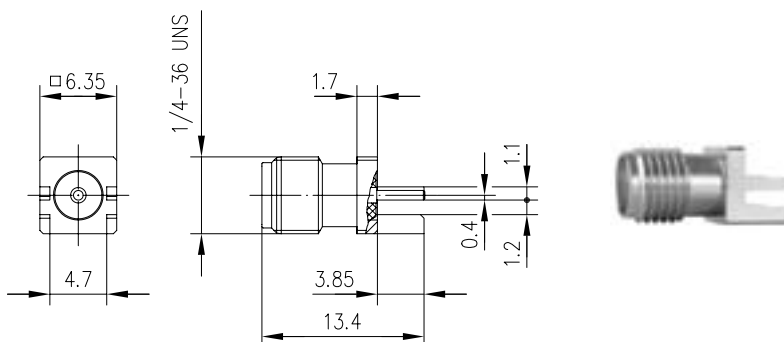

Order No. Bestell-Nr.	Remarks Anmerkungen
J01151A1201	For PCB thickness 1.07mm/0.042" Leiterplattenstärke 1.07mm/0.042"

8.18

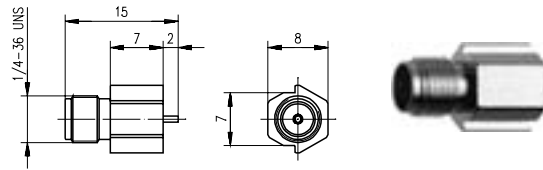
SMA Edge-Mount Jack in SMT
SMA-Edge-Mount Buchse in SMT

Order No. Bestell-Nr.	Finish Oberfläche	Remarks Anmerkungen	Mount. dim. Einbaumaß
J01151A0411	Gold	Edge-Mount-Type	Z89

8.19

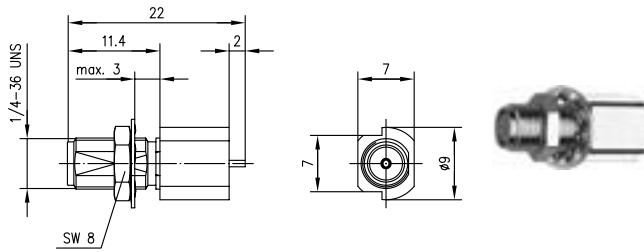
SMA-Edge-Mount Bulkhead Receptacle, female, in SMT
SMA-Edge-Mount Einbaubuchse in SMT

Order No. Bestell-Nr.	Finish Oberfläche	Mount. dim. Einbaumaß
J01151A0451	Gold	Z36/Z97

8.20

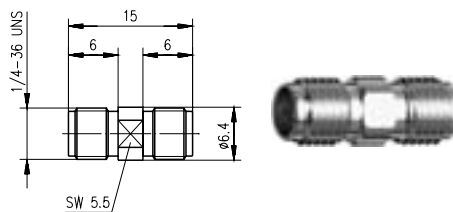
SMA Adaptor
SMA-Kupplung

Order No. Bestell-Nr.	Finish Oberfläche	Remarks Anmerkungen	Return Loss Return Loss
J01154A0001	Gold	f-f Bu-Bu	36 dB/1 GHz; 26 dB/6 GHz

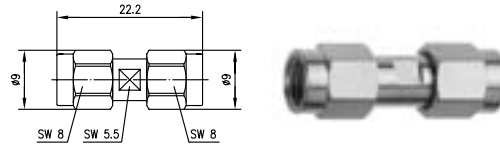

Order No. Bestell-Nr.	Finish Oberfläche	Remarks Anmerkungen
J01154A0031	Gold	m-m Sti-Sti

SMA Angle Adaptor
SMA-Winkelkupplung

8.21

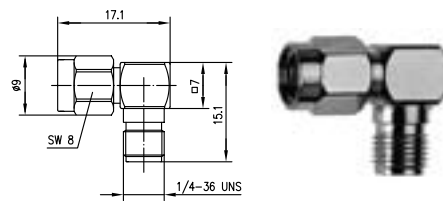

Order No. Bestell-Nr.	Finish Oberfläche	Remarks Anmerkungen	Return Loss Return Loss
J01154A0021	Gold	m-f Sti-Bu	38 dB/1 GHz; 21 dB/6 GHz

SMA Bulkhead Adaptor
SMA-Verbindungsstück

8.22

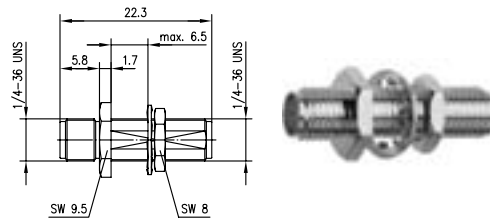

Order No. Bestell-Nr.	Finish Oberfläche	Remarks Anmerkungen	Mount. dim. Einbaumaß	Return Loss Return Loss
J01154A0041	Gold	f-f Bu-Bu	Z36	40 dB/1 GHz; 25 dB/6 GHz

8.23

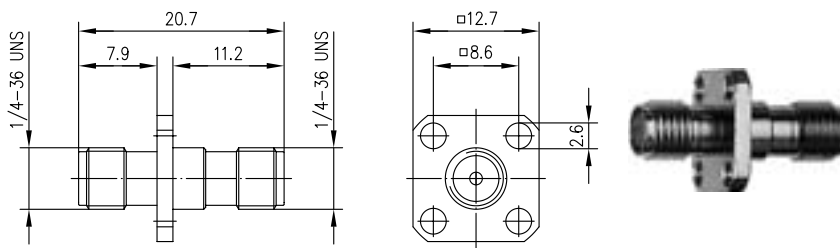
SMA Panel Adaptor
SMA-Einbaukupplung mit Flansch

Order No. Bestell-Nr.	Finish Oberfläche	Remarks Anmerkungen	Mount. dim. Einbaumaß	Return Loss Return Loss
J01154A0011	Gold	f-f Bu-Bu	Z29	44.5 dB/1 GHz; 30.5 dB/4 GHz
J01154A0019	Nickel	f-f Bu-Bu	Z29	44.5 dB/1 GHz; 30.5 dB/4 GHz

8.24

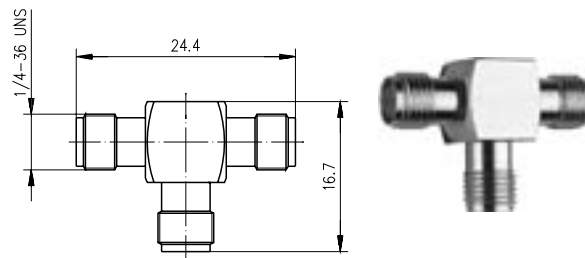
SMA T Adaptor
SMA-T-Stück

Order No. Bestell-Nr.	Finish Oberfläche	Remarks Anmerkungen
J01155A0011	Gold	f-f-f Bu-Bu-Bu

SMA Surge Suppressor
SMA Überspannungsableiter

8.25

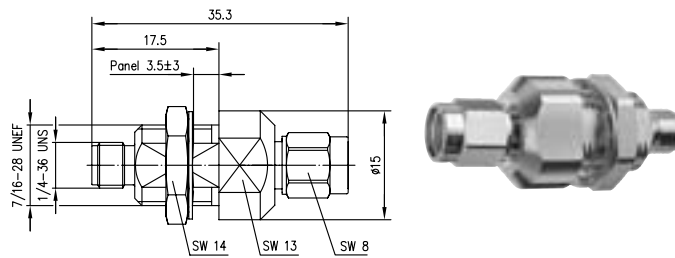

Order No. Bestell-Nr.	Technical Information Technische Daten	Finish Oberfläche	Remarks Anmerkungen	Mount. dim. Einbaumaß
J01158A0001	25 W; 150 V - 250 V spark over voltage	Gold	m-f with gas discharge, frequency range up to 6 GHz, bulkhead type Sti-Bu mit Gasentladungsableiter; Frequenzbereich: 0-6 GHz; Einbautyp	Z03

SMA Dust Cap
SMA-Abdeckkappe

8.26



Order No. Bestell-Nr.	Finish Oberfläche	Remarks Anmerkungen
H00040A0011	Gold	with chain, IP 68 mit Kette, IP 68

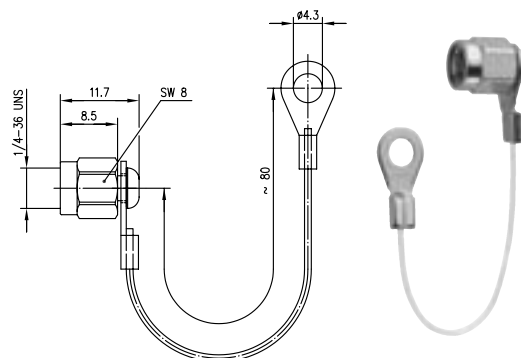

Order No. Bestell-Nr.	Finish Oberfläche	Remarks Anmerkungen
H00040A0020	Gold	nylon string, IP 68 Nylon-Schnur, IP 68

8.26

8.26

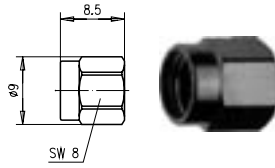
SMA Dust Cap
SMA-Abdeckkappe

Order No. Bestell-Nr.	Finish Oberfläche	Remarks Anmerkungen
H00040A0001	Gold	IP 68

8.27

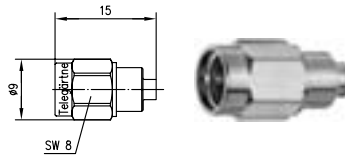
SMA Termination Plug
SMA-Abschlusswiderstand

Order No. Bestell-Nr.	Finish Oberfläche	Max. Frequency Max. Frequenz	Max. Power Max. Leistung	Return Loss Return Loss
J01152A0011	Gold	6 GHz	1 W	34 dB/2 GHz; 23 dB/6 GHz
J01152A0018	Telealloy (white bronze)	6 GHz	1 W	34 dB/2 GHz; 23 dB/6 GHz
J01152B0011	Gold	18 GHz	1 W	35 dB/2 GHz; 20 dB/18 GHz
J01152B0018	Telealloy (white bronze)	18 GHz	1 W	35 dB/2 GHz; 20 dB/18 GHz